

FREZ DO PŁYCIN DO DRZWICZEK MEBLOWYCH

Adres URL: <https://mill-tech.pl/frezy-do-drewna/frez-do-plycin-do-drzwiczek-meblowych/>

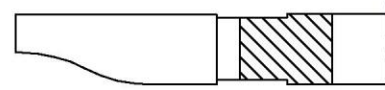

FPM-1

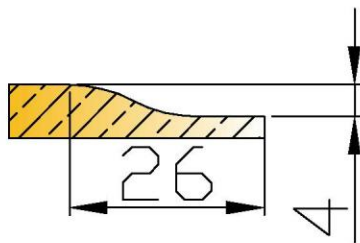
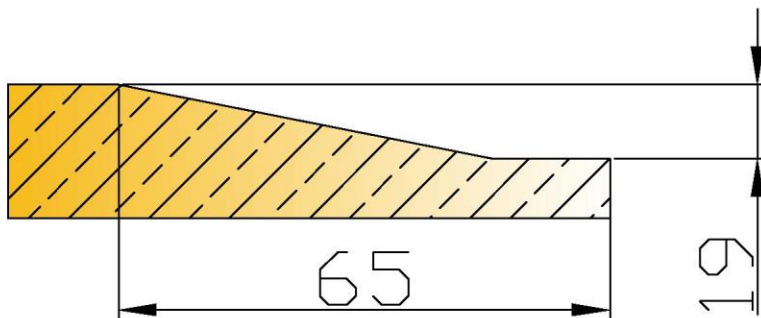
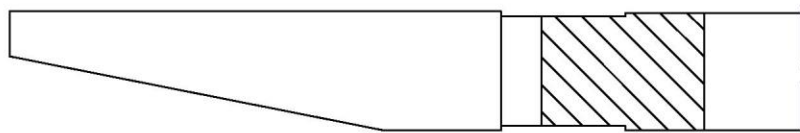

FPM-2

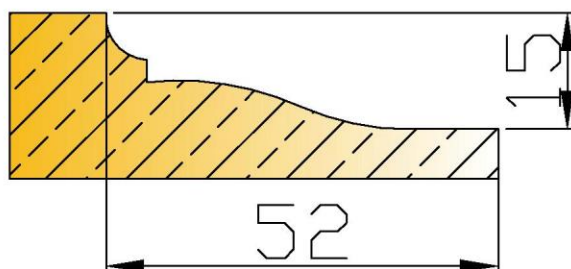
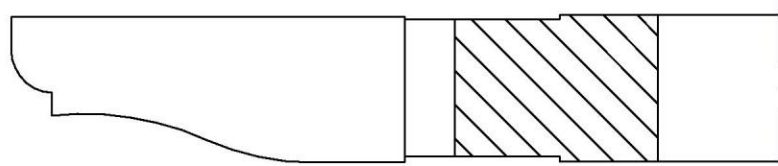

FPM-3

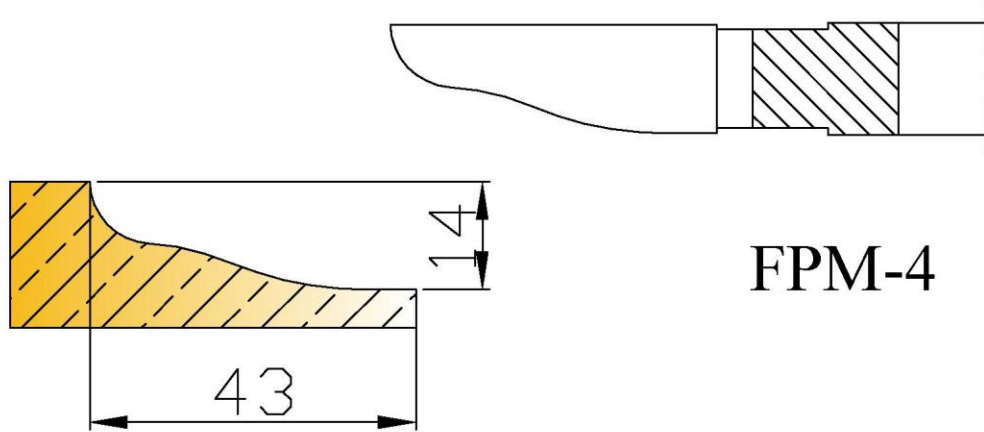
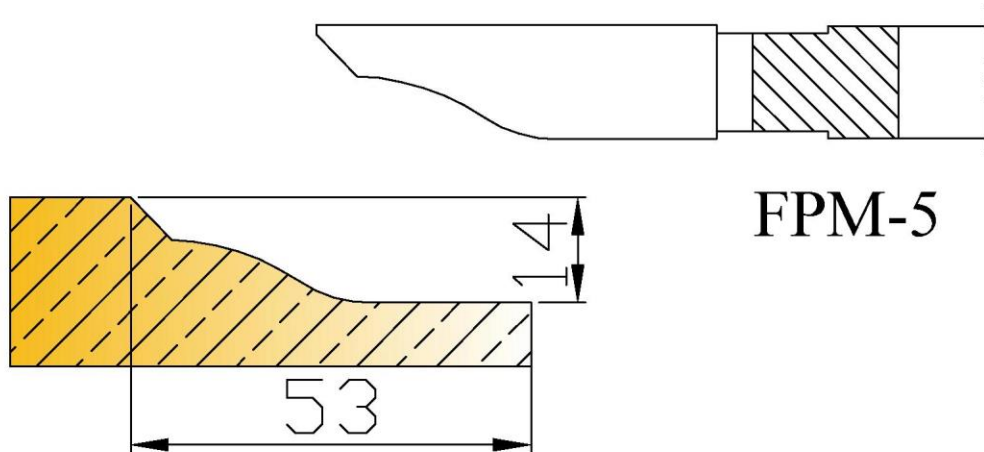
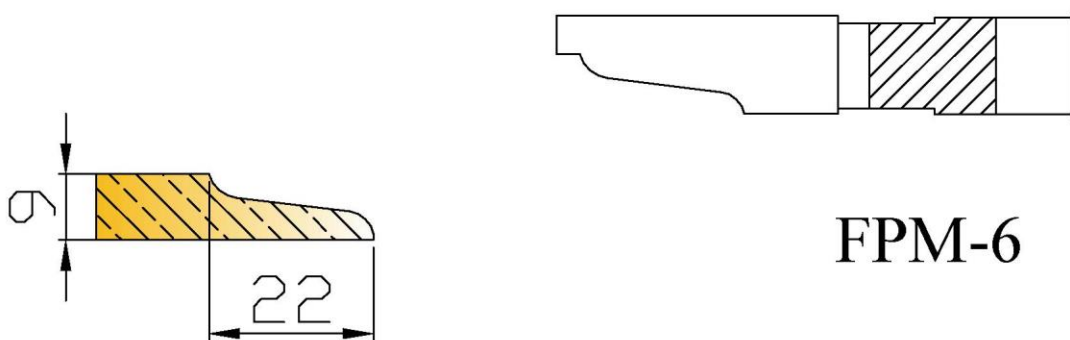
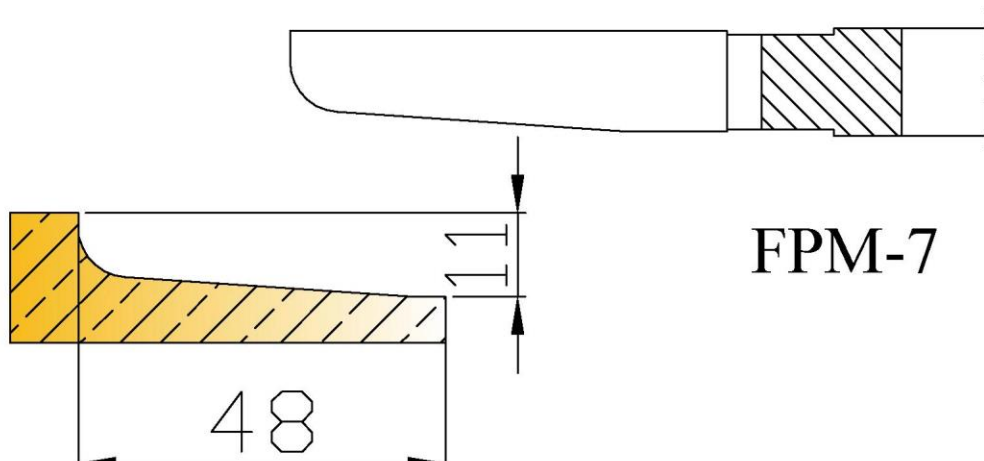
**FPM-4****FPM-5****FPM-6****FPM-7**

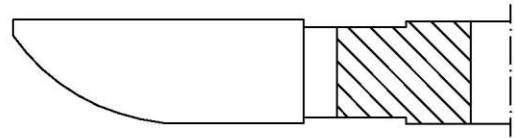
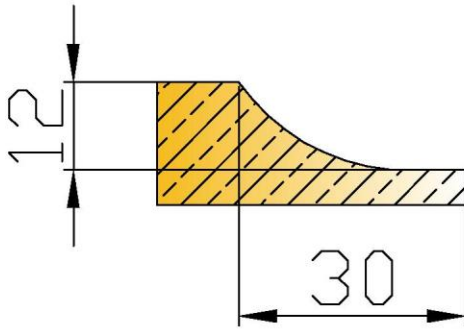
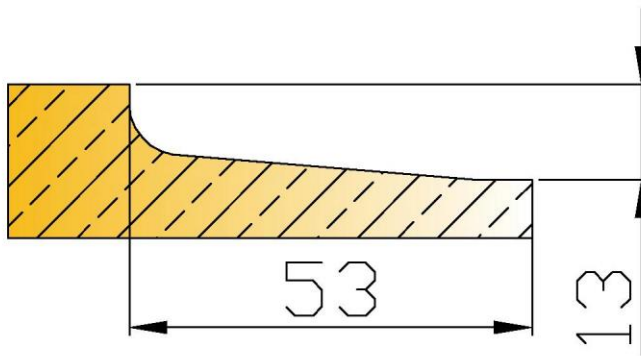
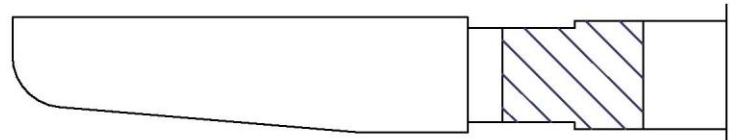
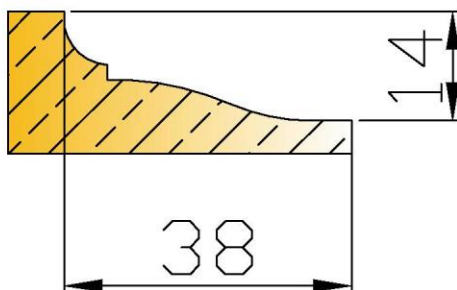
**FPM-8****FPM-9****FPM-10**