

FREZ KSZTAŁTOWY

Adres URL: <https://mill-tech.pl/frezy-do-drewna/frez-ksztaltowy/>

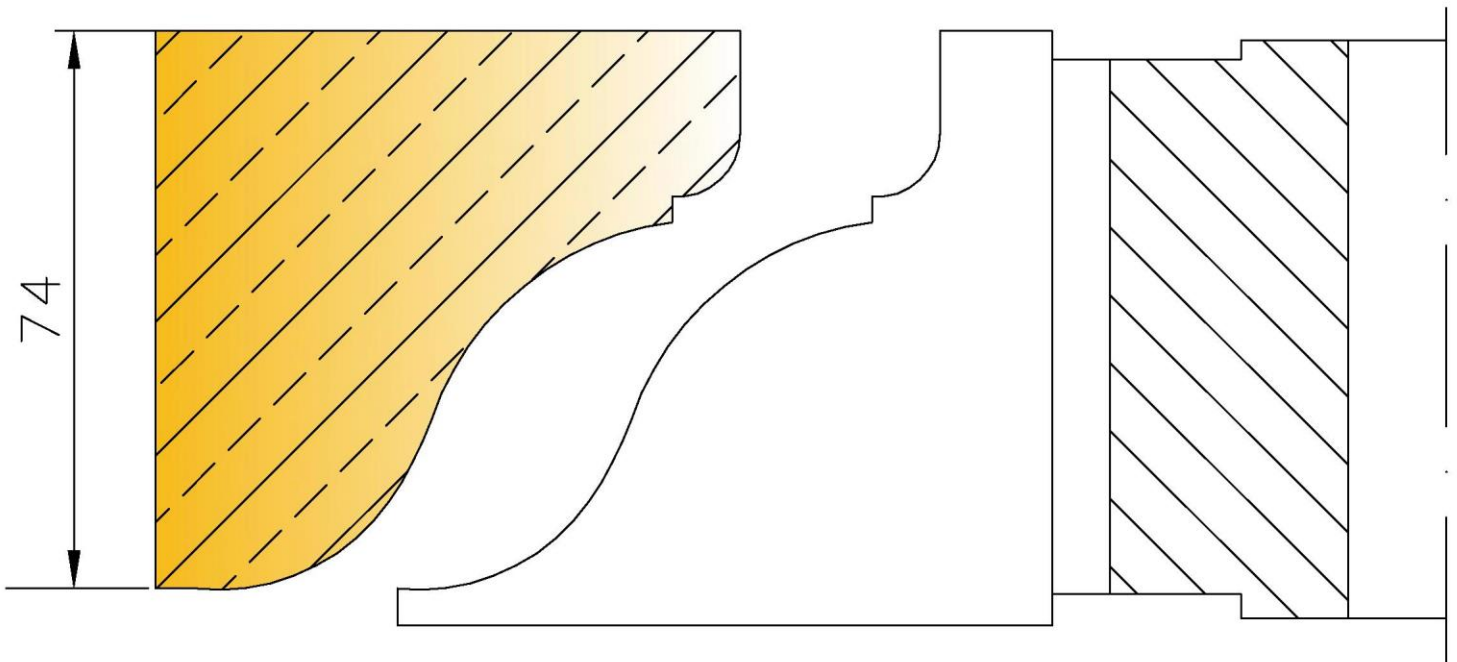

FK-1

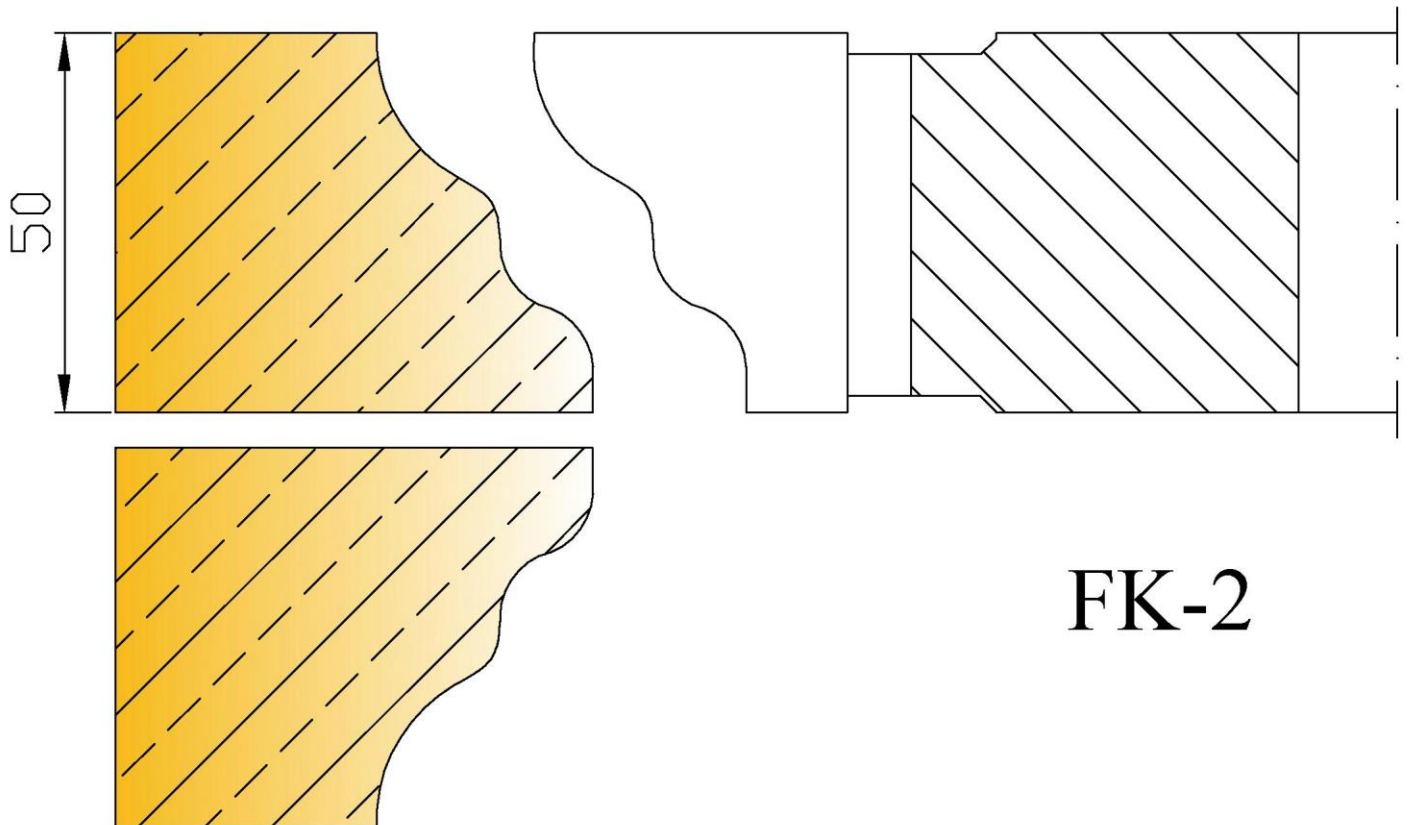

FK-2

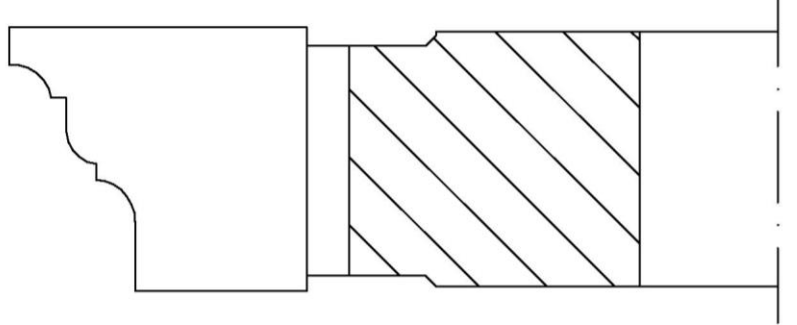
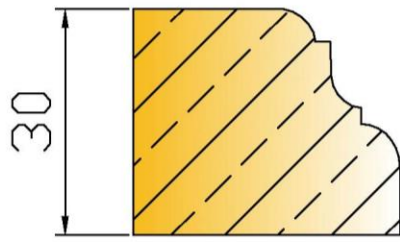

FK-3

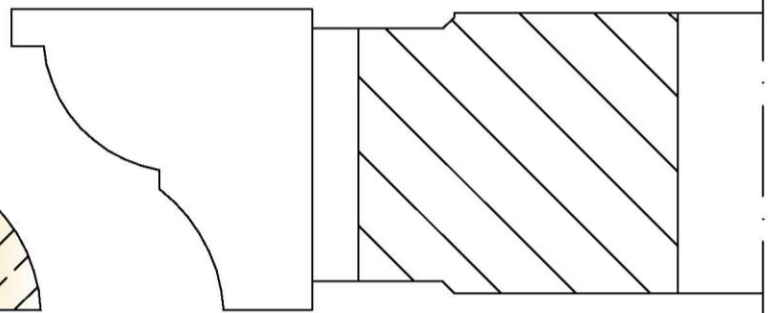
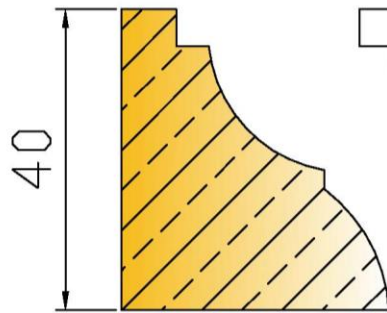

FK-4

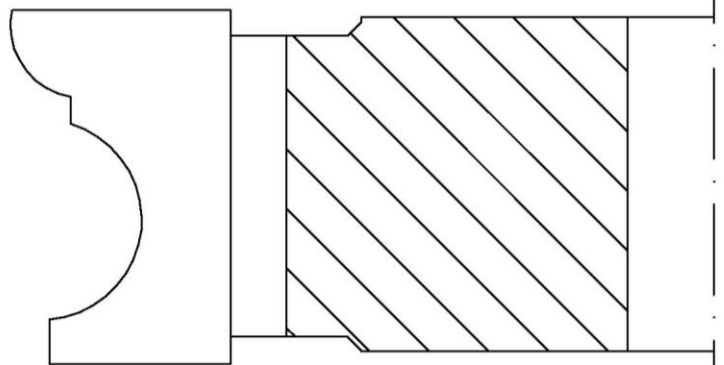
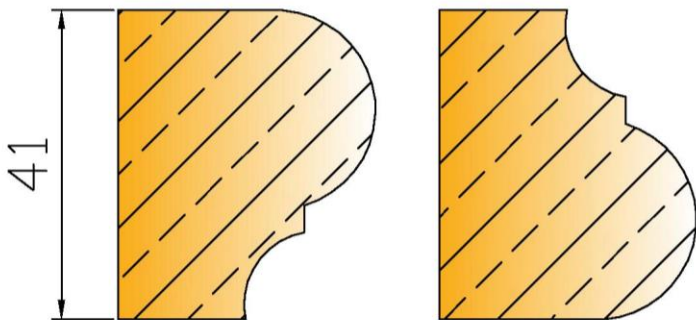

FK-5

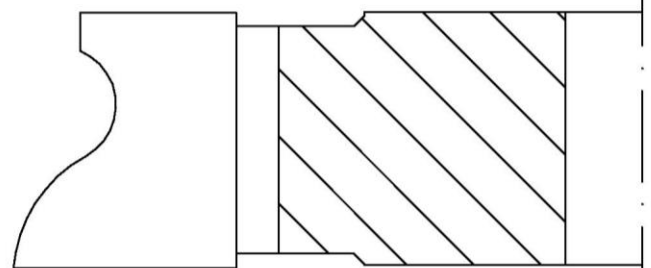
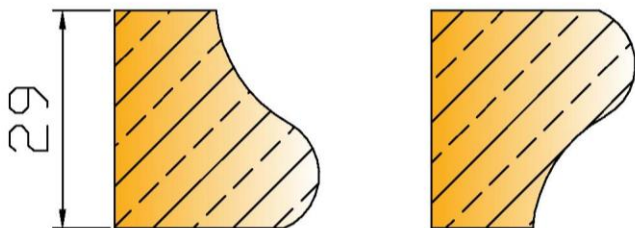

FK-6

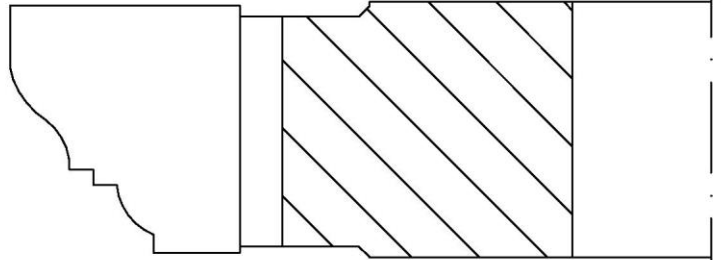
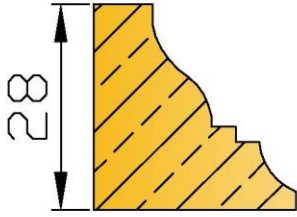

FK-7

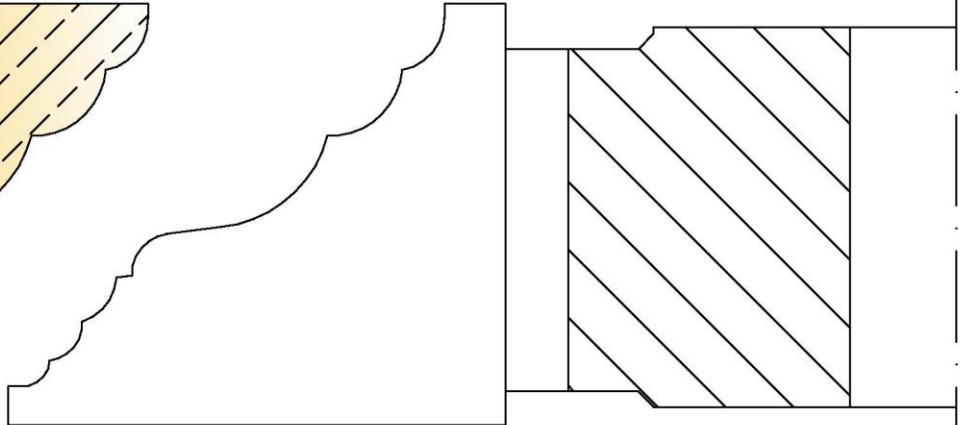
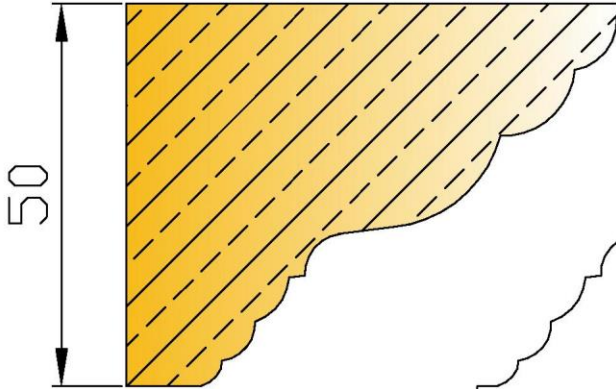

FK-8

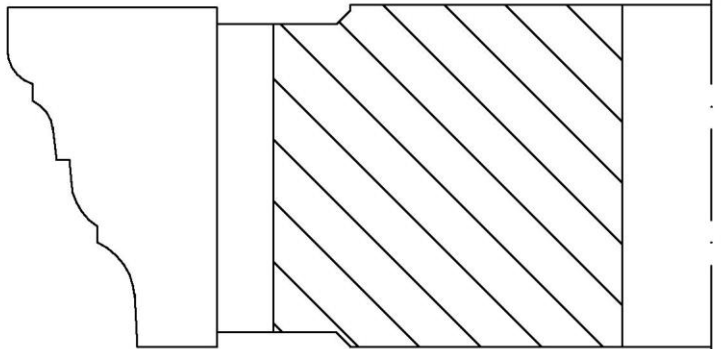
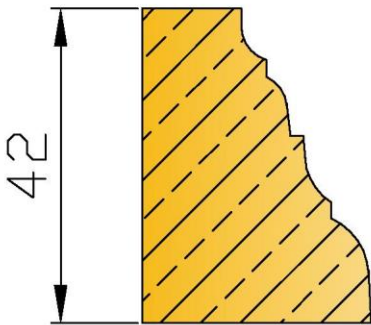

FK-9

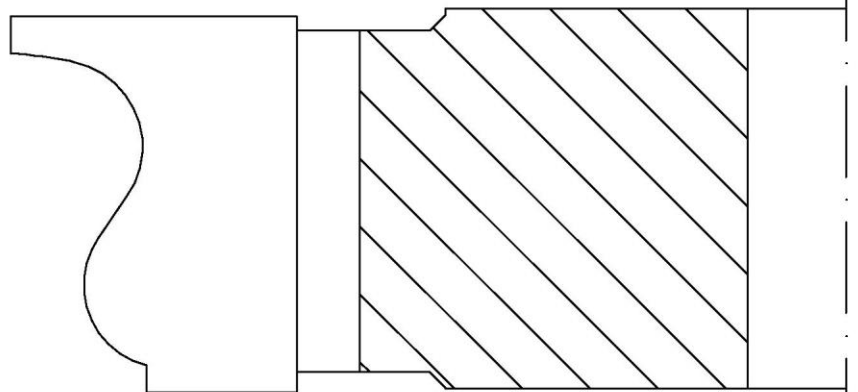
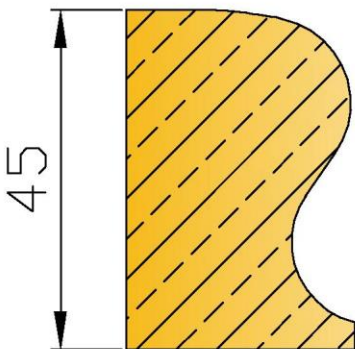

FK-10

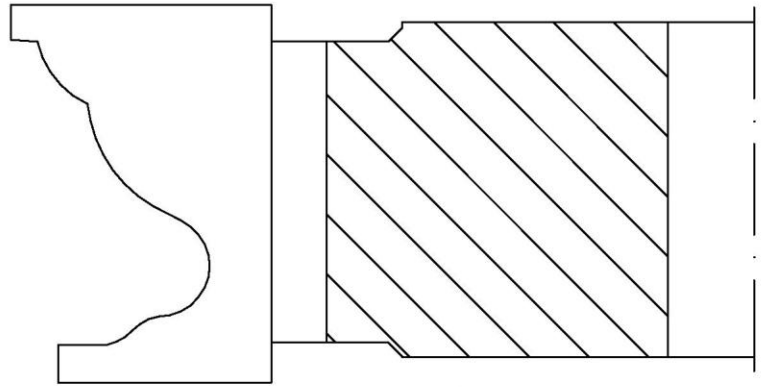
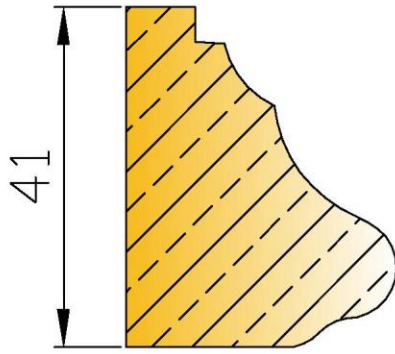

FK-11

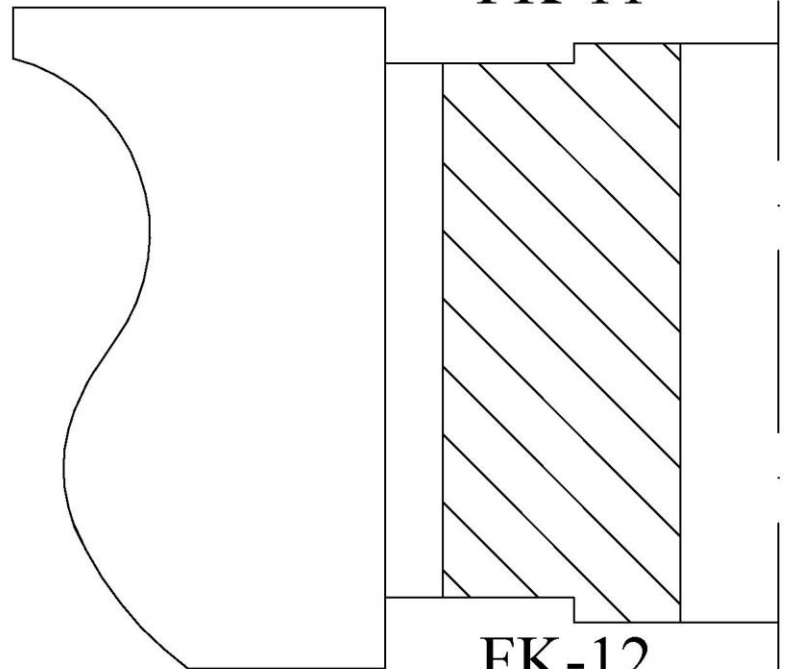
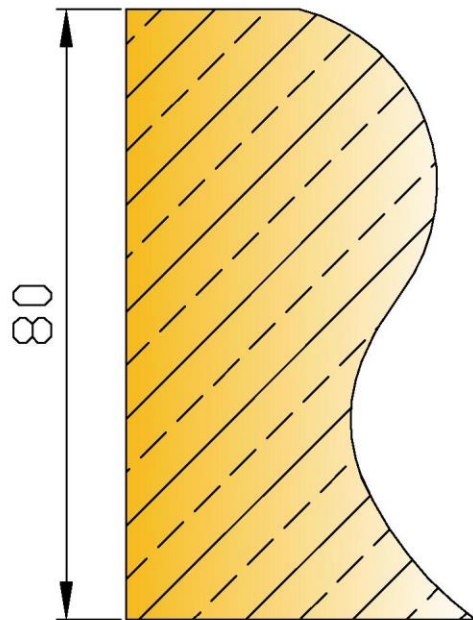

FK-12

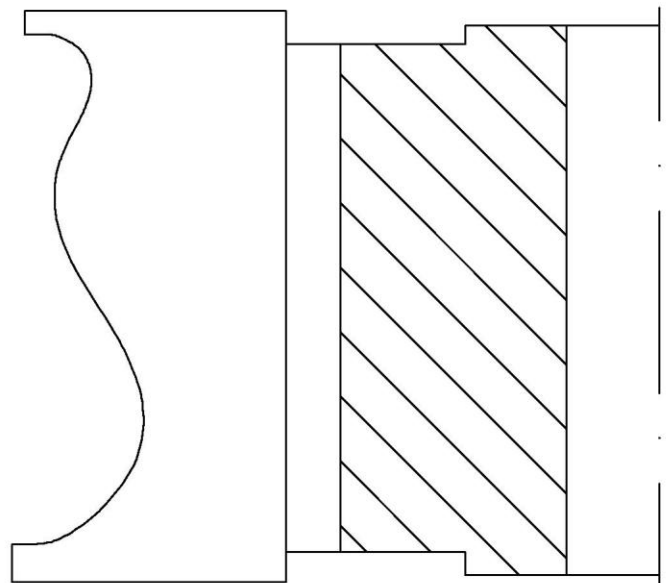
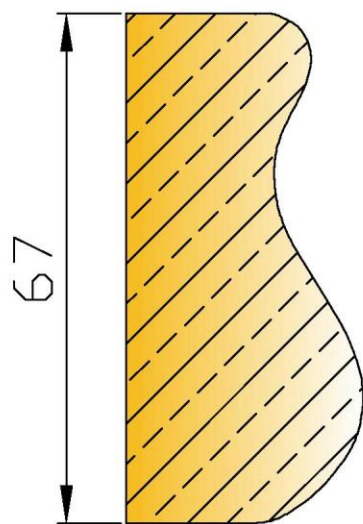

FK-13

51

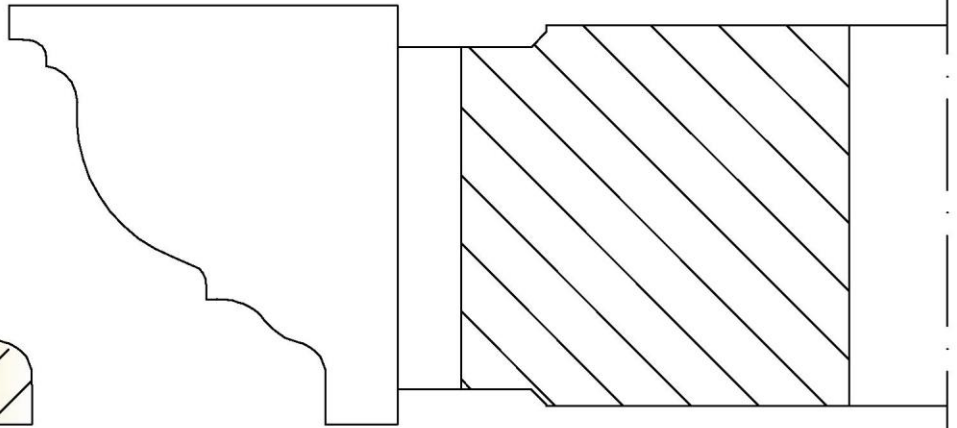
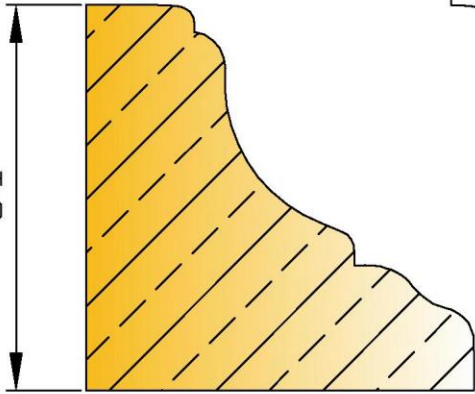

FK-14

54

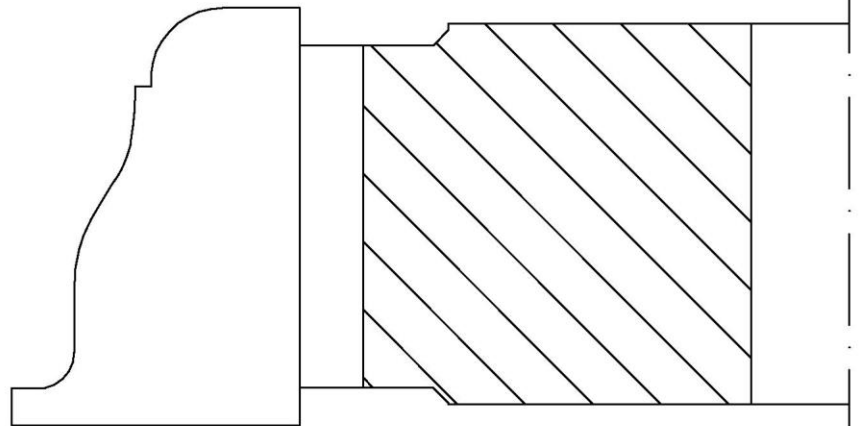
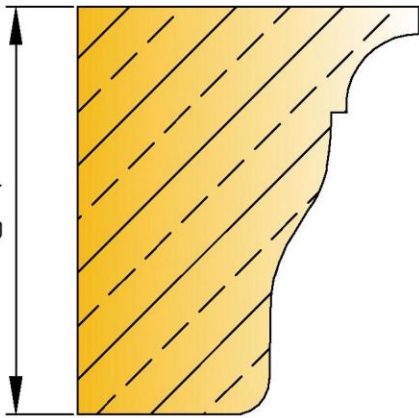

FK-15

53

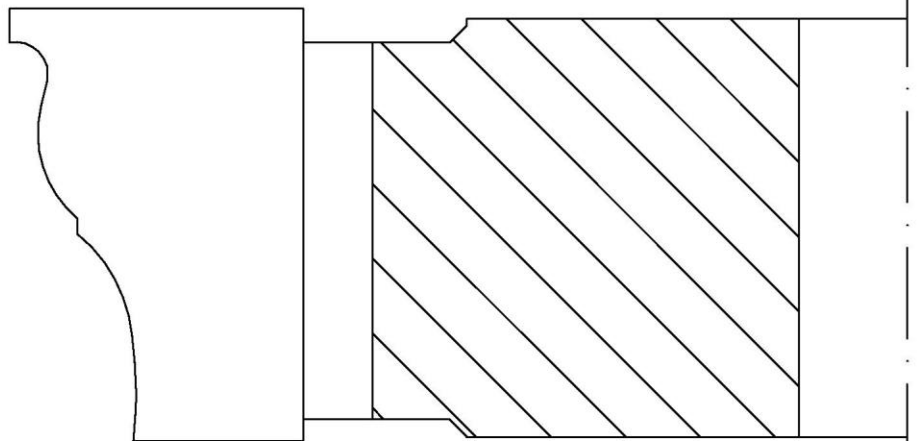
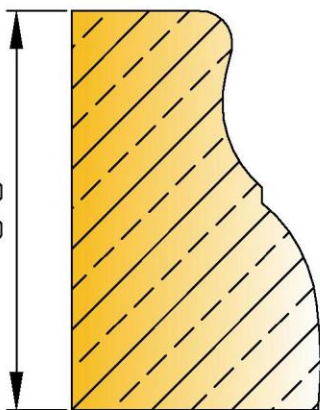

FK-16

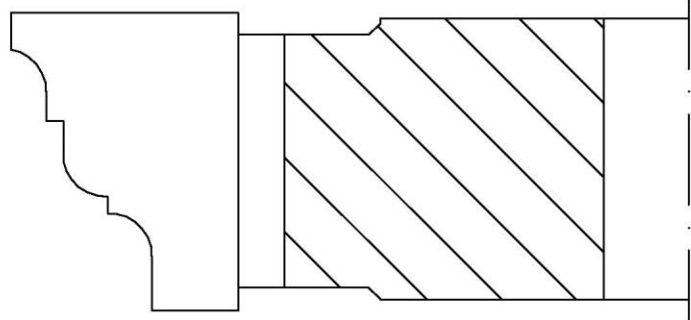
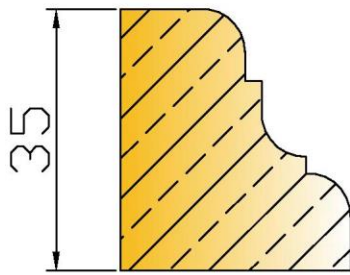

FK-17

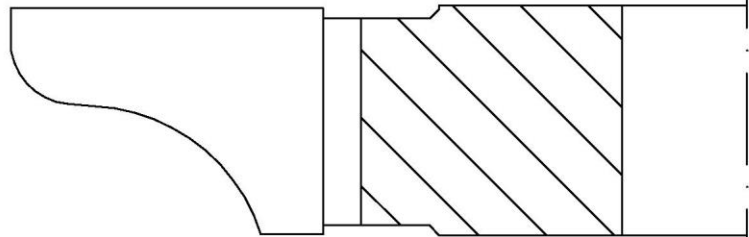
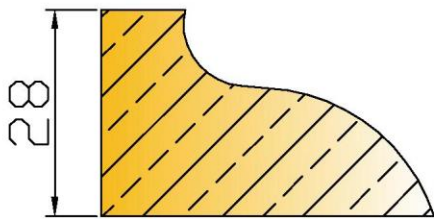

FK-18

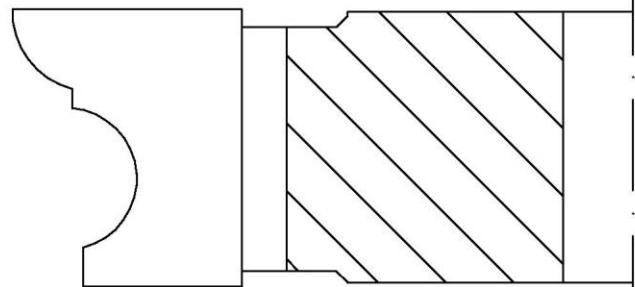
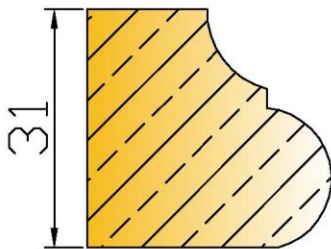

FK-19

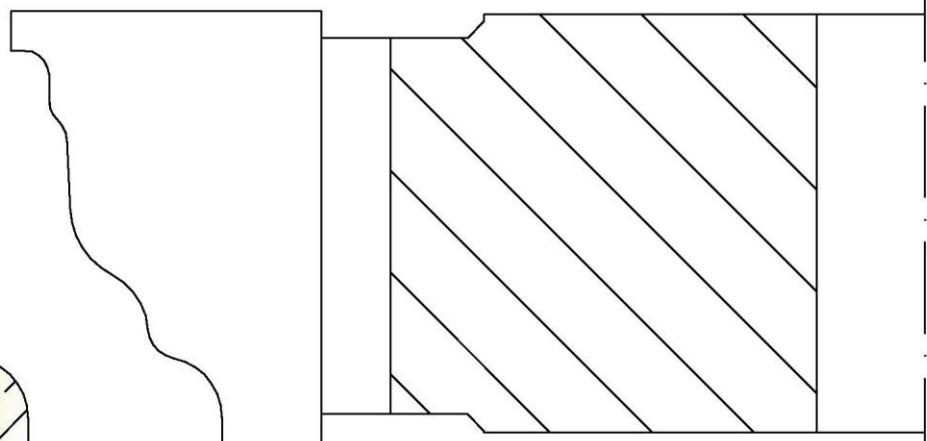
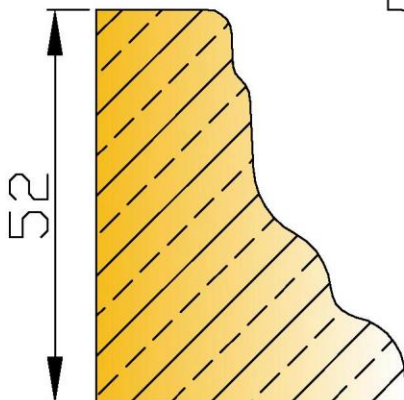

FK-20

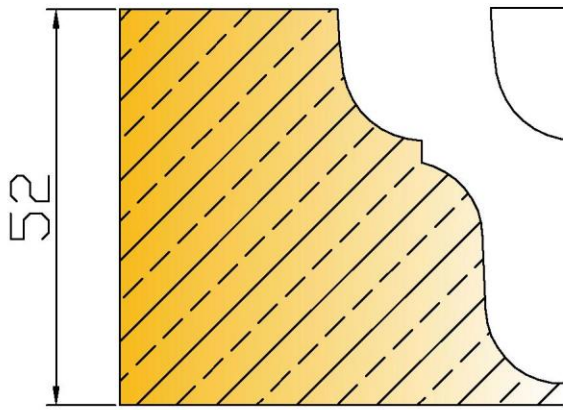

52

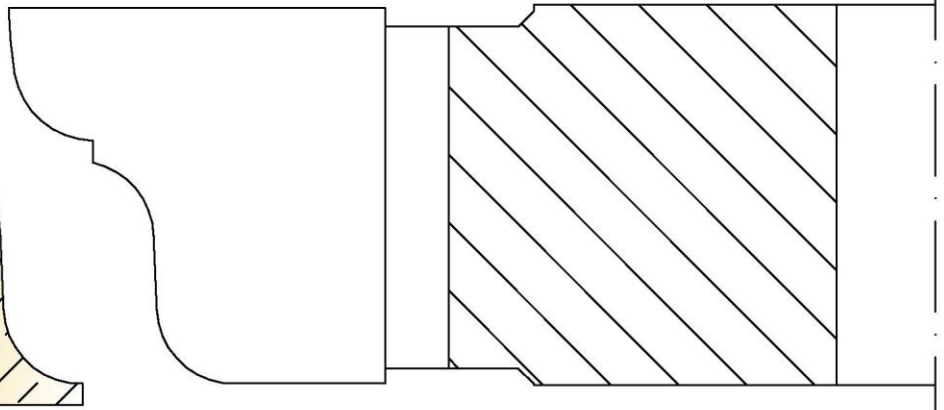

FK-21

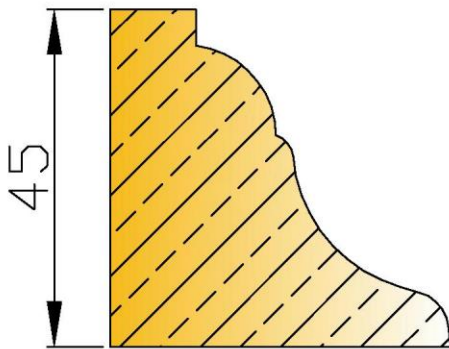

45

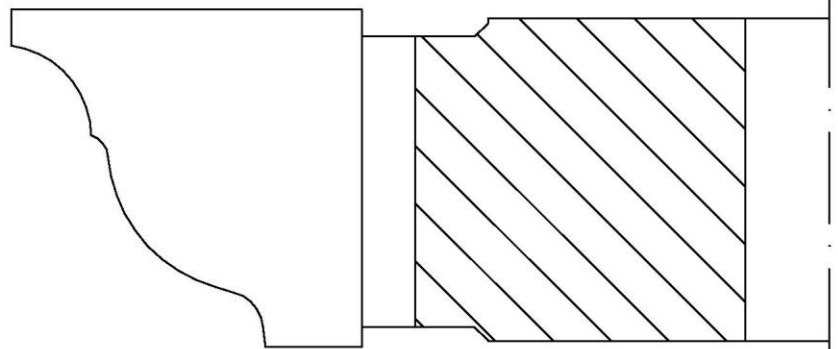

FK-22

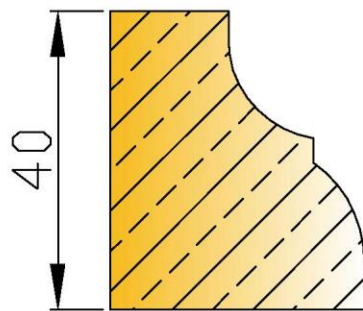

40

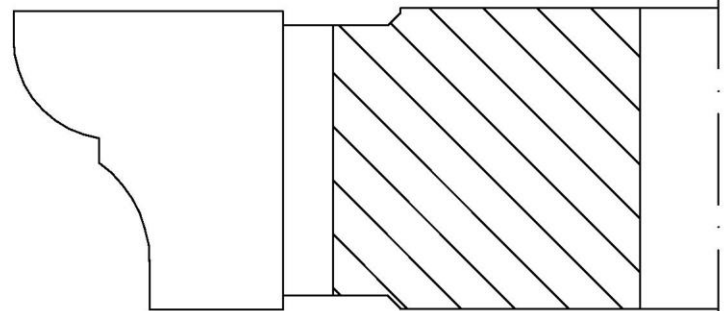

FK-23

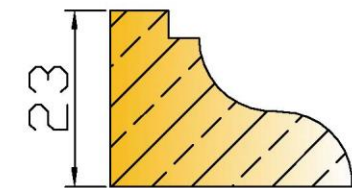

23

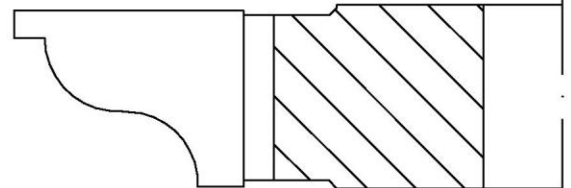

FK-24

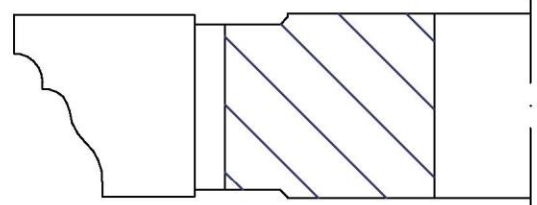
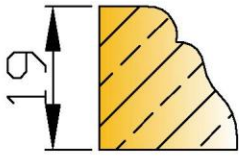

FK-25

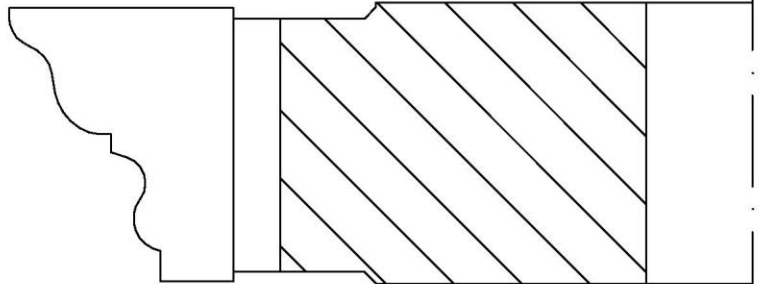
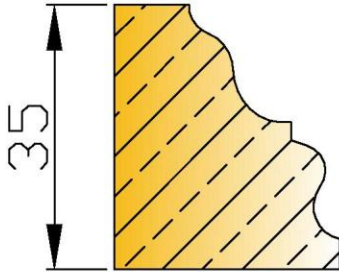

FK-26

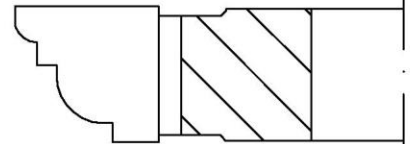
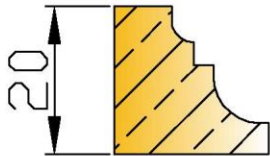

FK-27

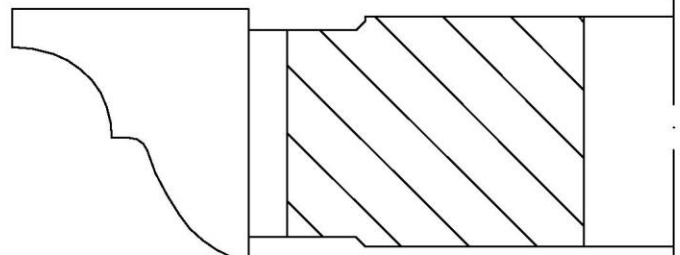
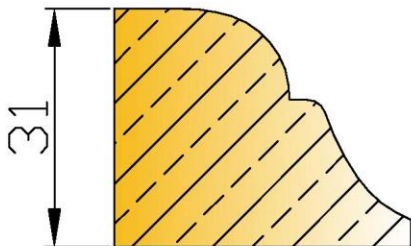

FK-28

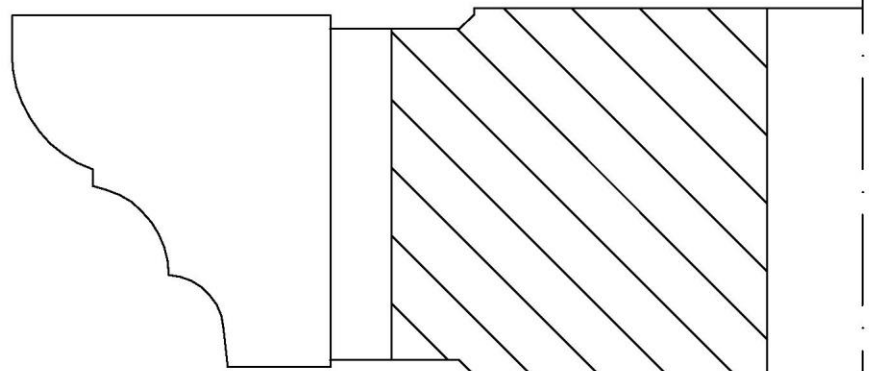
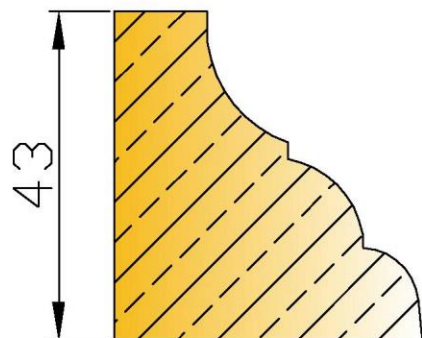

FK-29

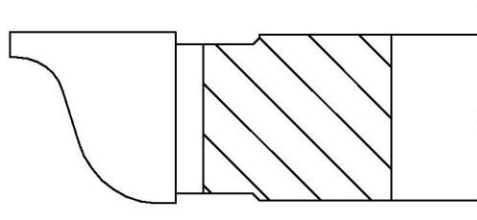
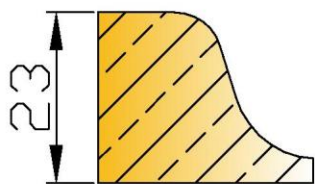

FK-30

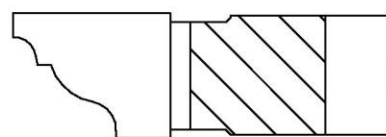
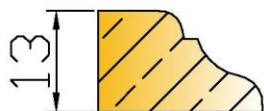

FK-31

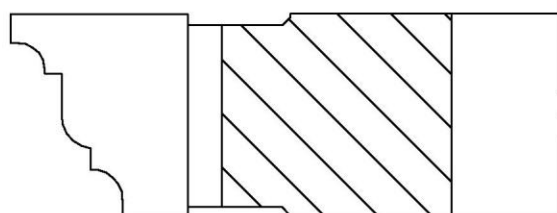

FK-32

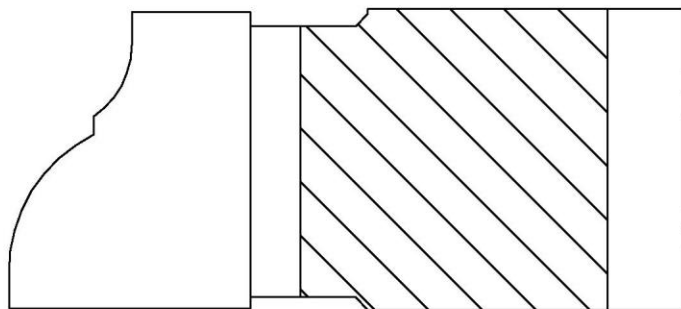
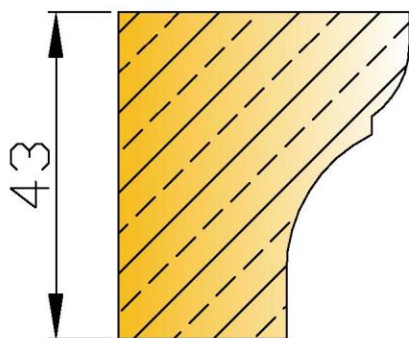

FK-33

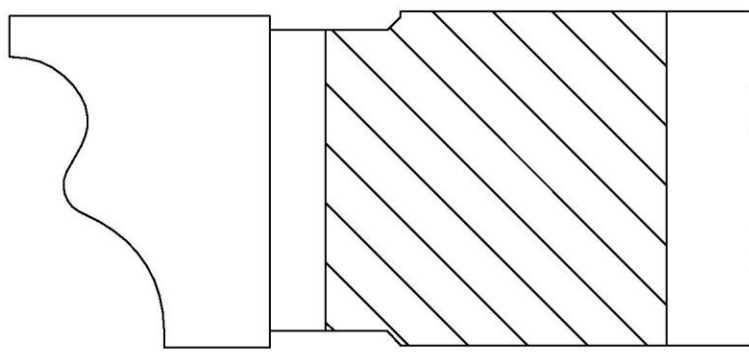
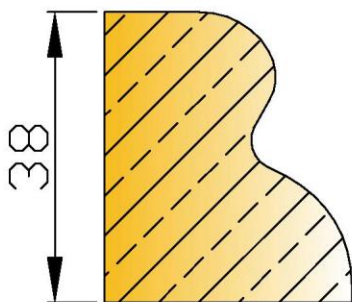

FK-34

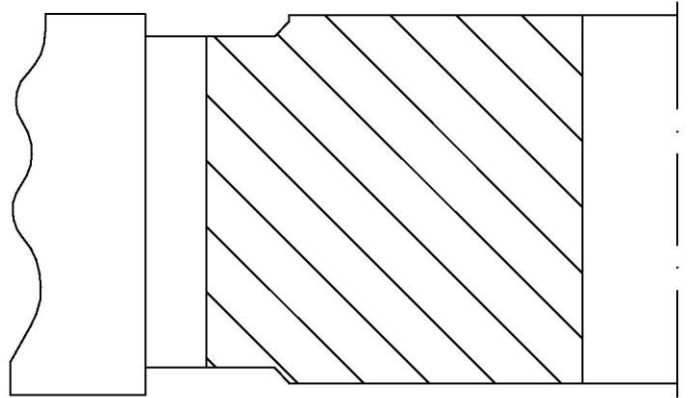
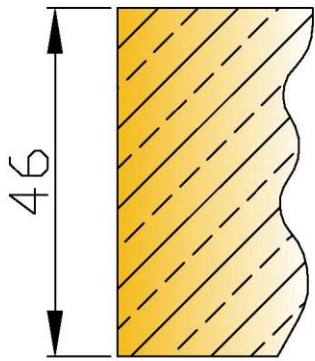

FK-35

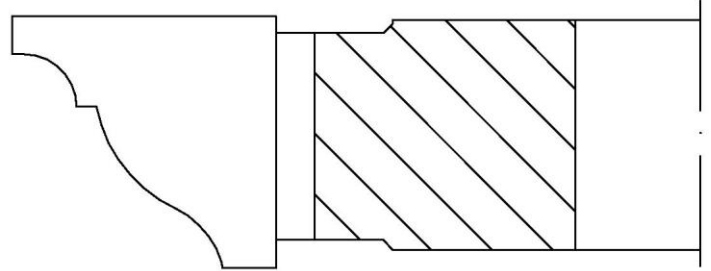
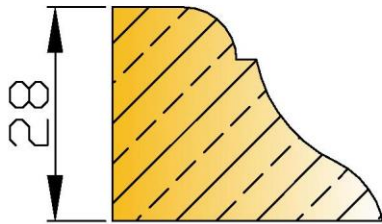

FK-36

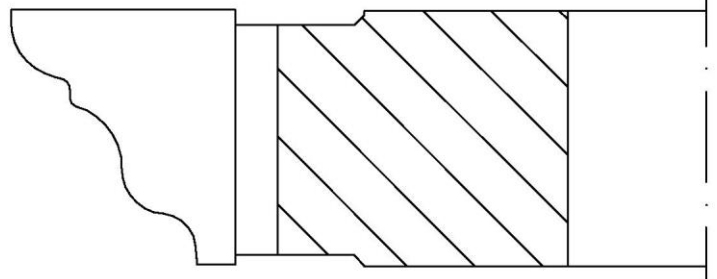
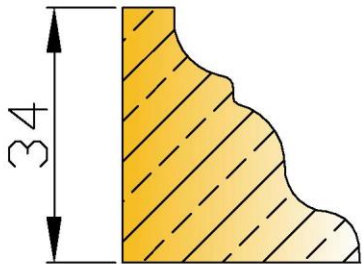

FK-37

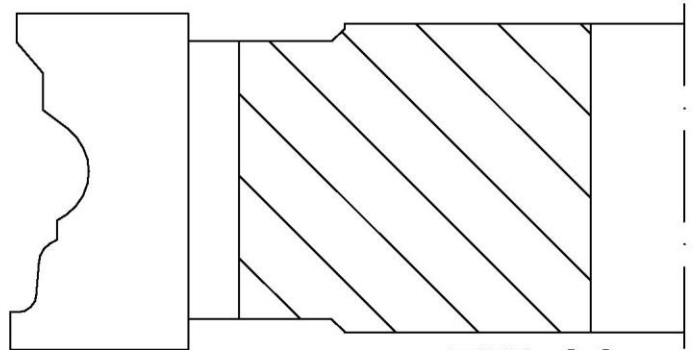
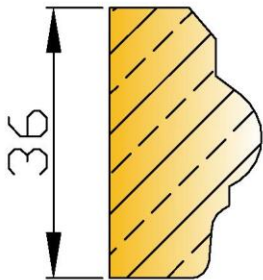

FK-38

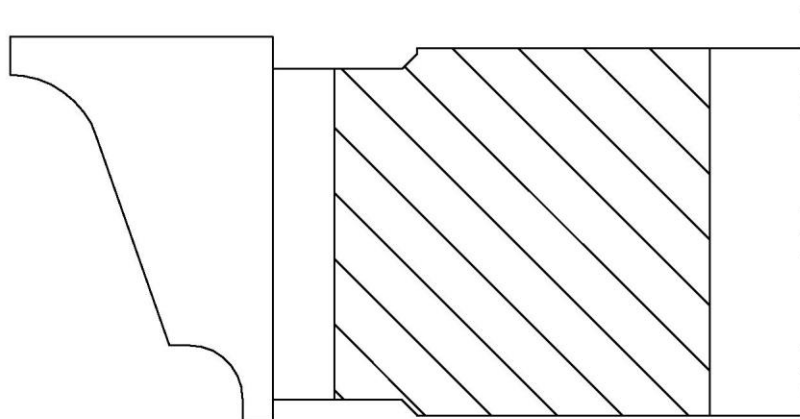
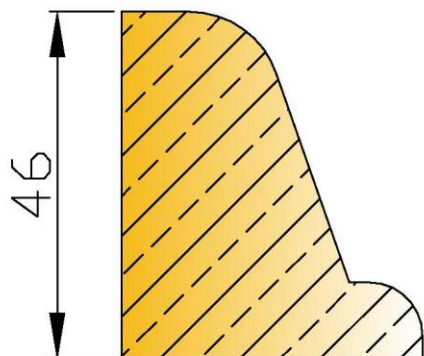

FK-39

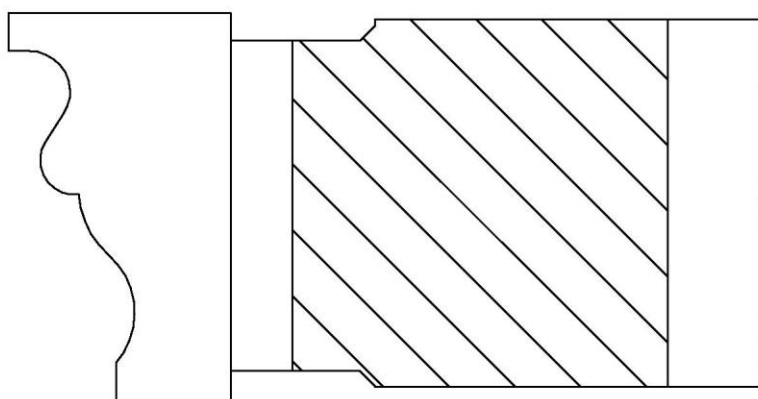
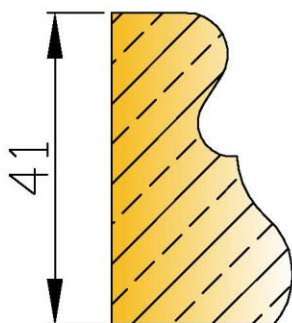

FK-40

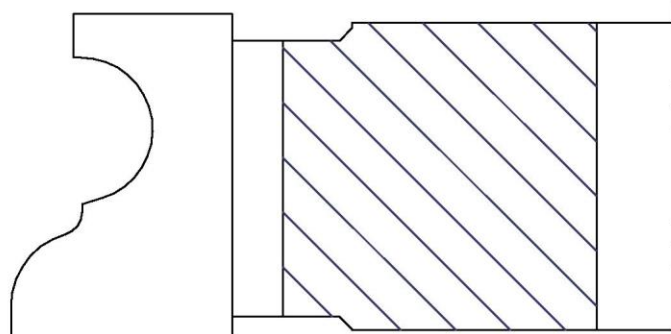
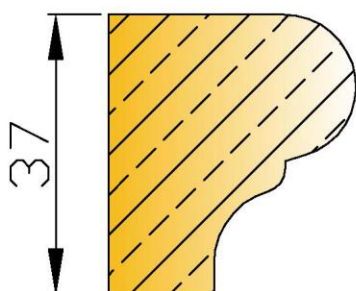

FK-41

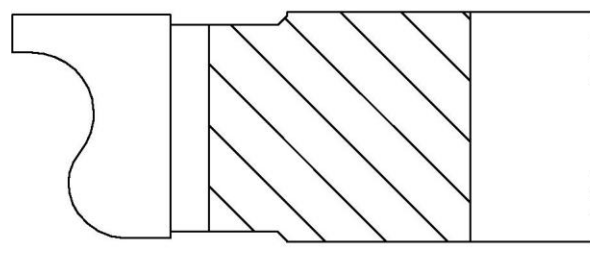
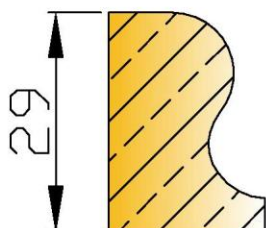

FK-42

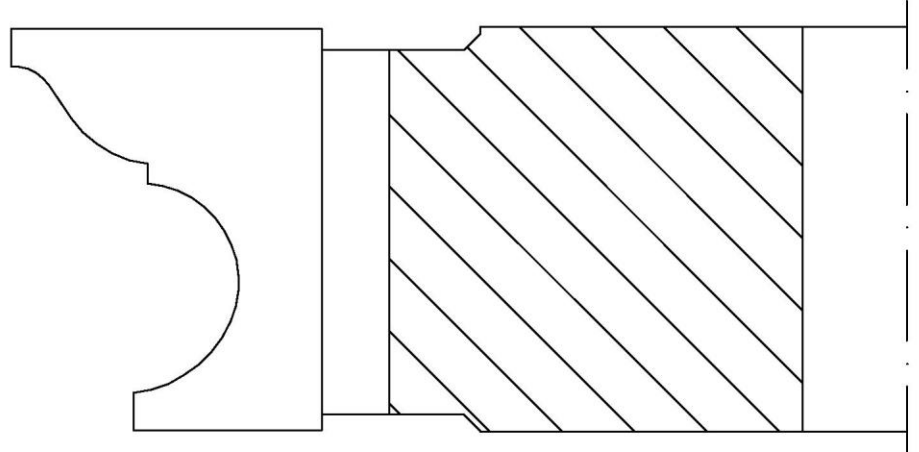
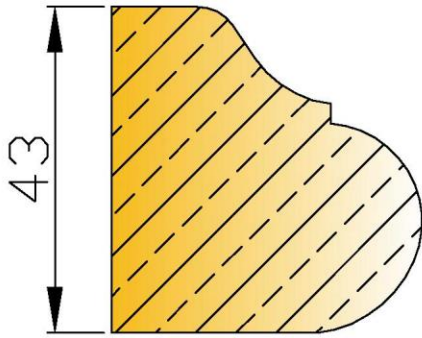

FK-43

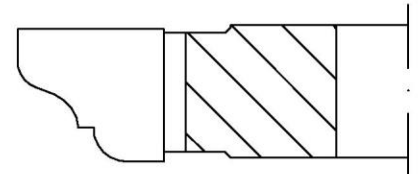
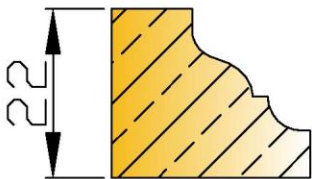

FK-44

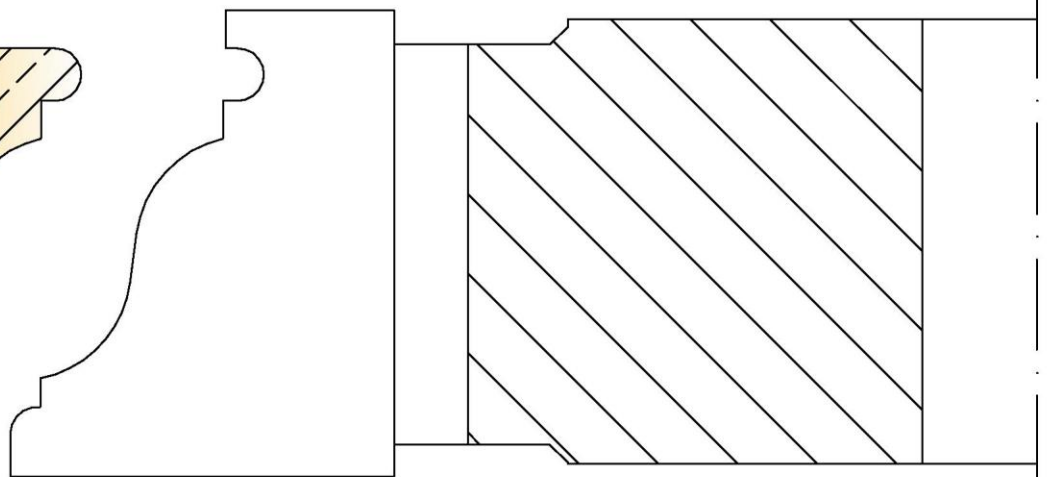
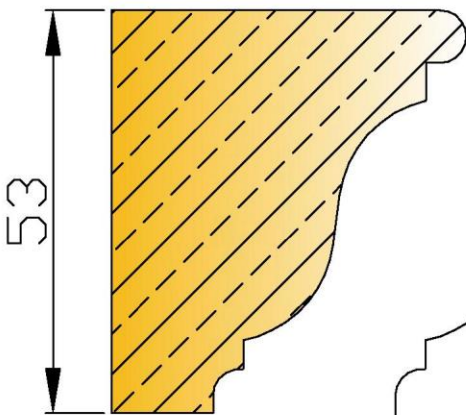

FK-45

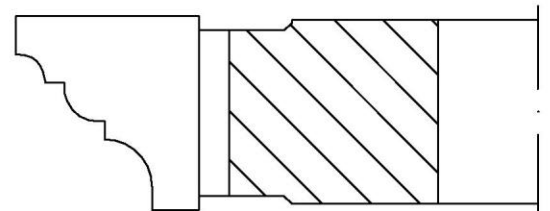
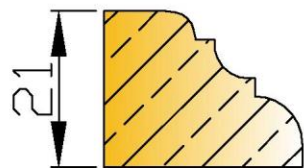

FK-46

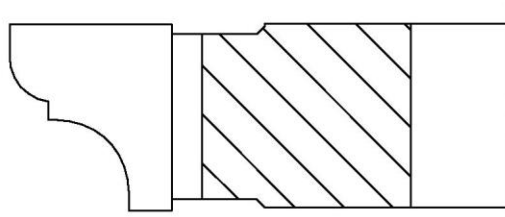
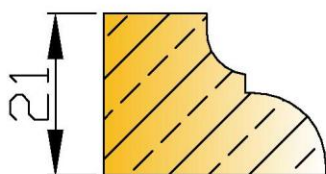

FK-47

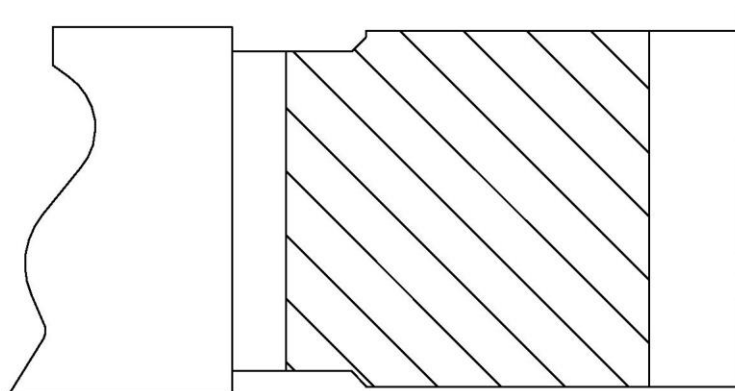
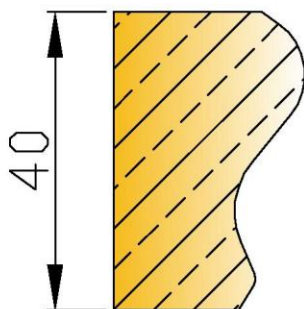

FK-48

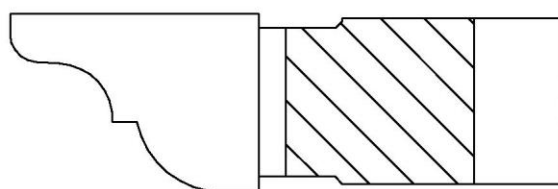
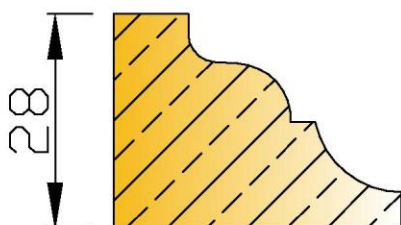

FK-49

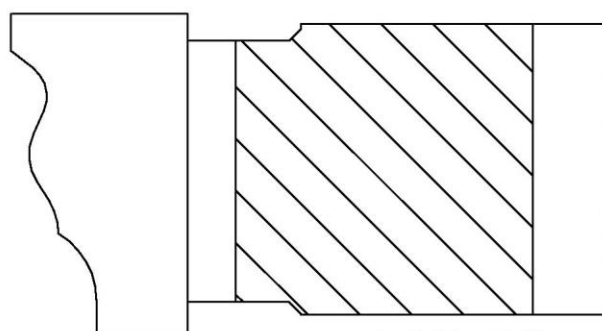
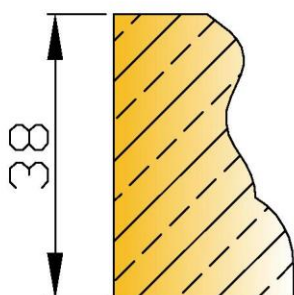

FK-50

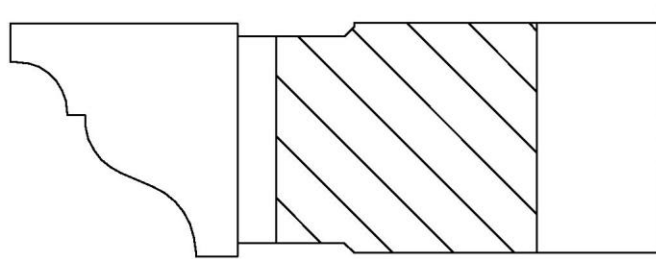
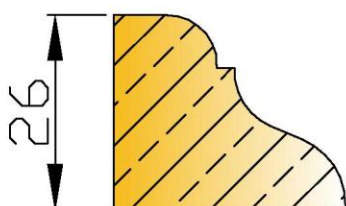

FK-51

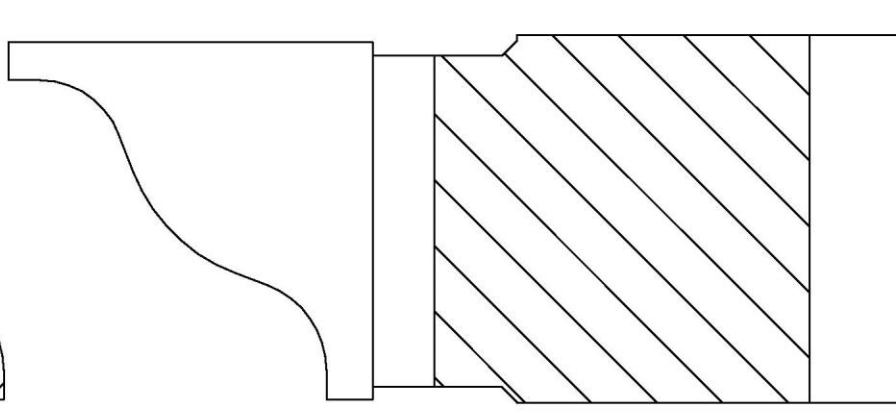
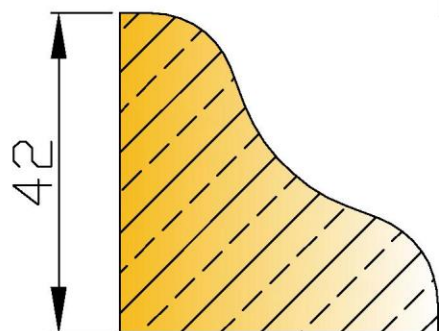

FK-52

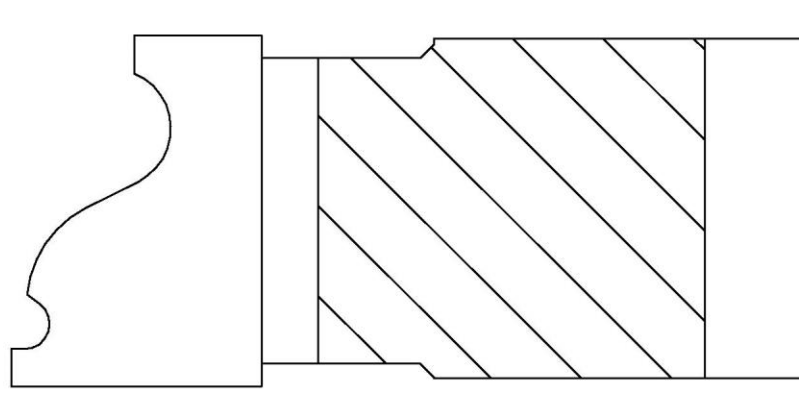
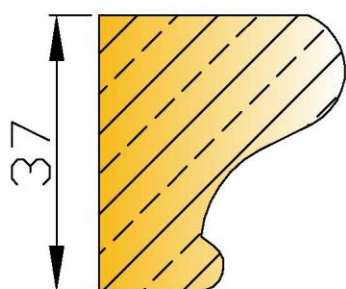

FK-53

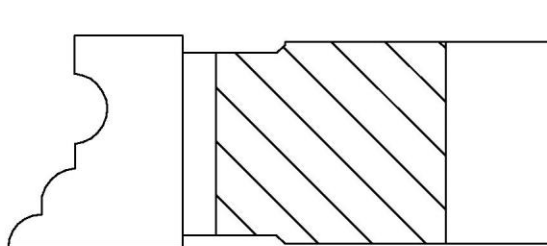
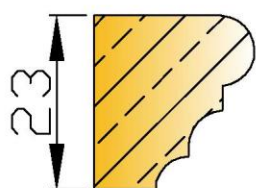

FK-54

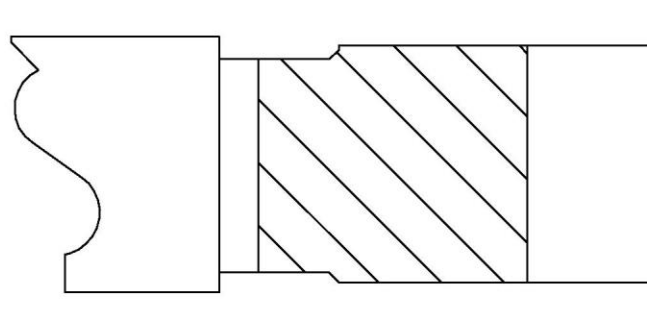
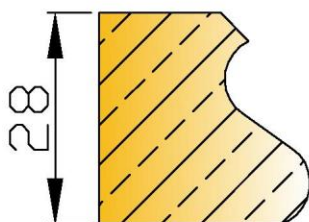

FK-55

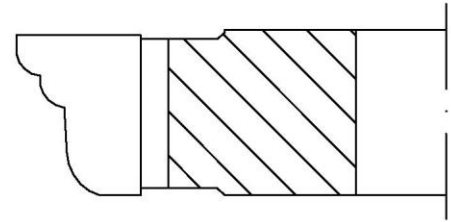
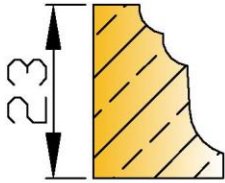

FK-56

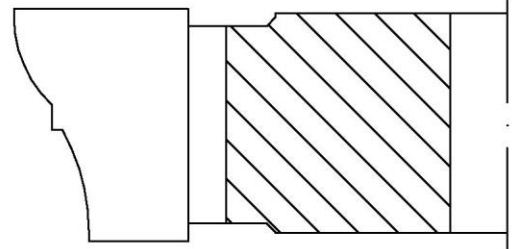
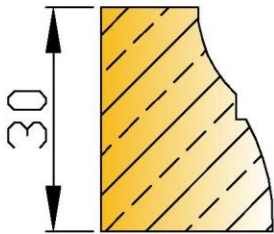

FK-57

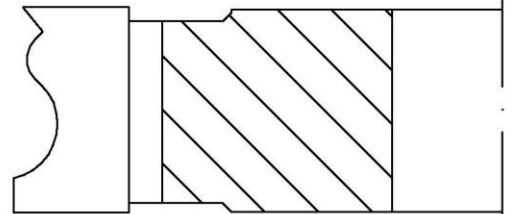
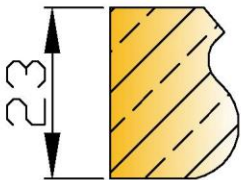

FK-58

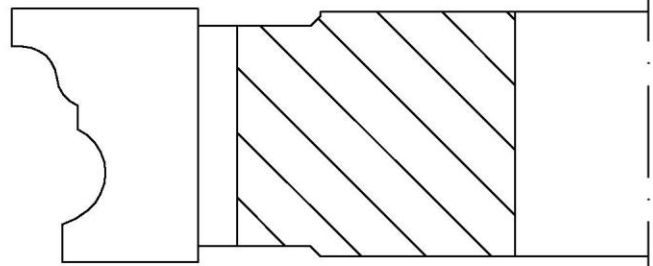
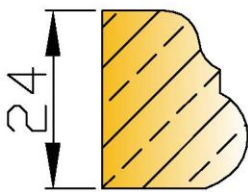

FK-59

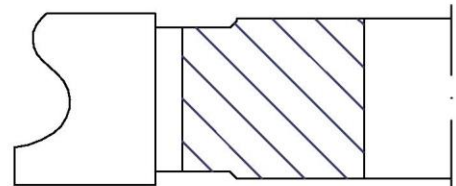
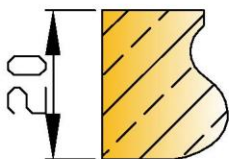

FK-60

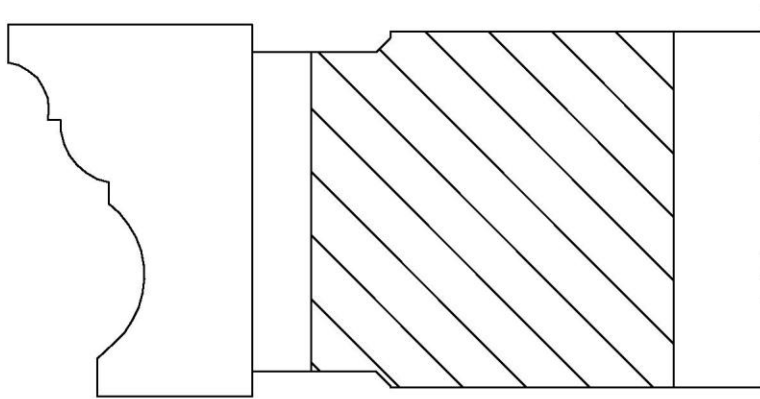
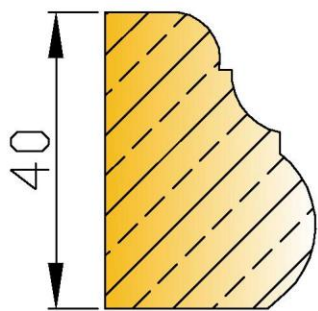

FK-61

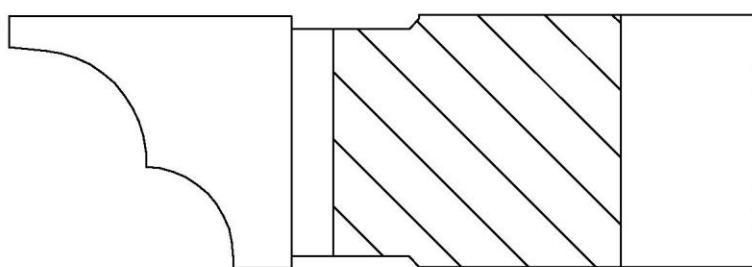
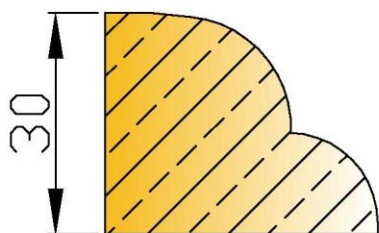

FK-62

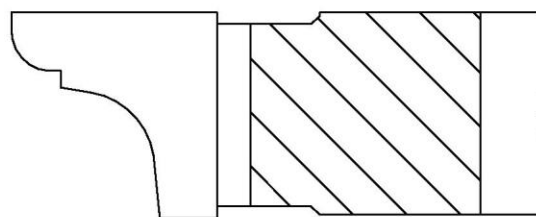
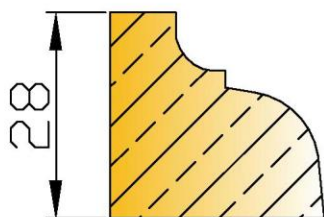

FK-63

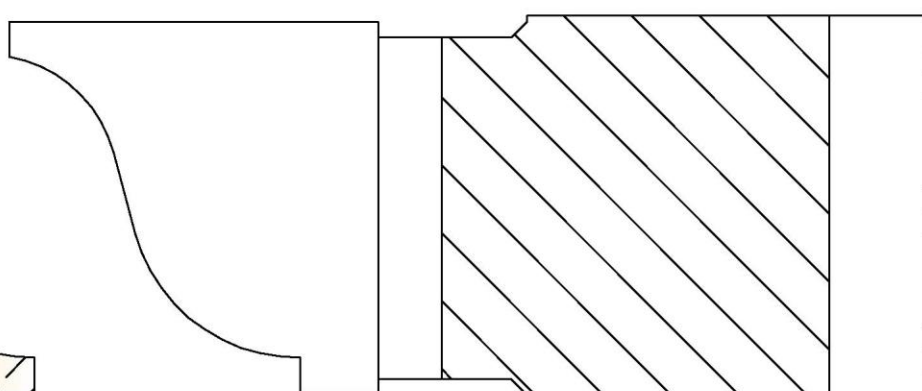
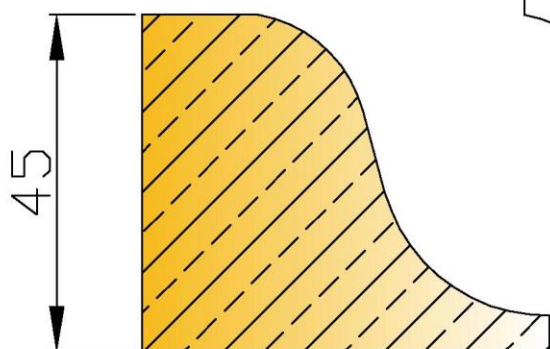

FK-64

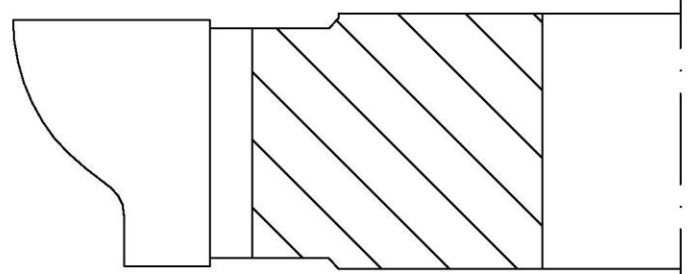
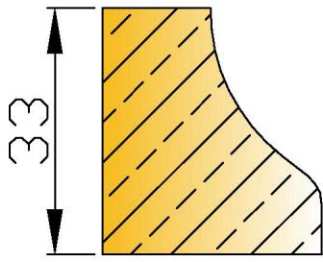

FK-65

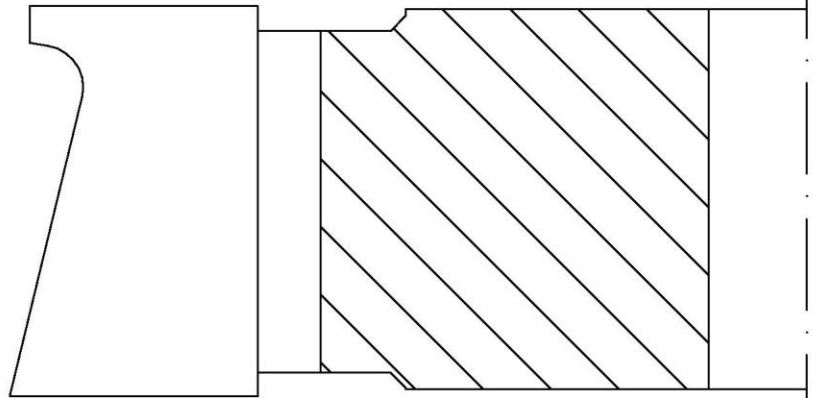
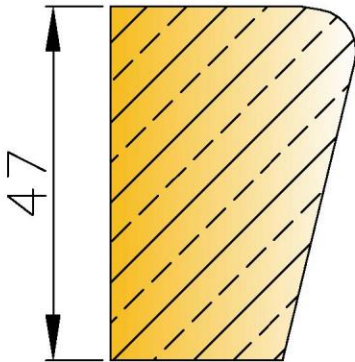

FK-66

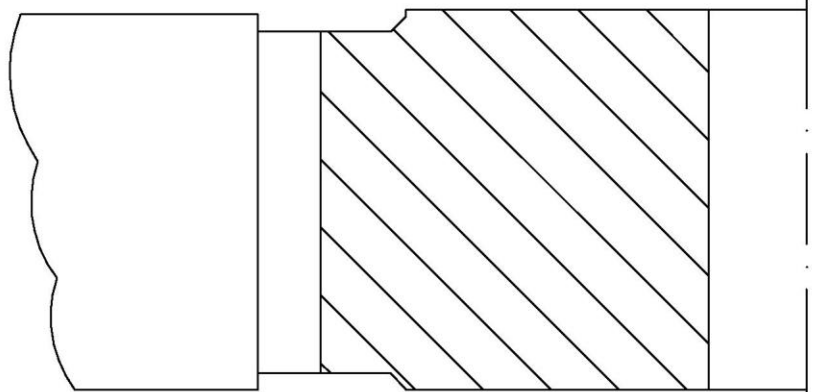
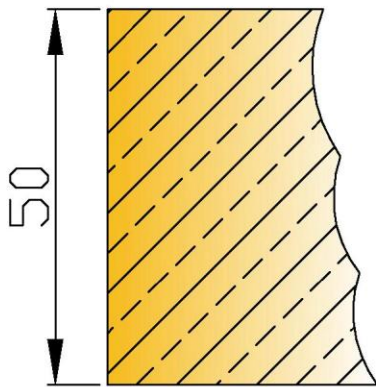

FK-67

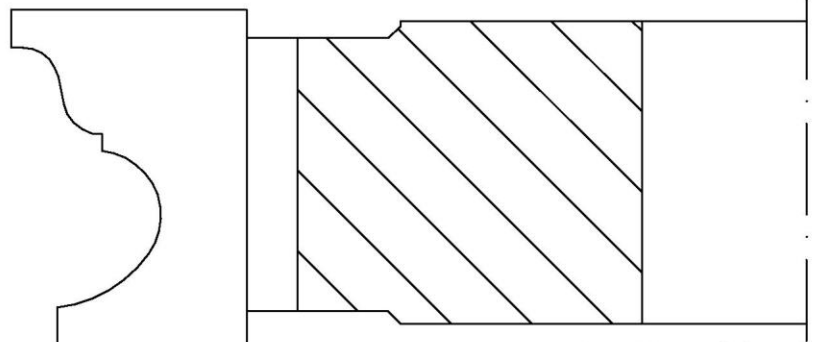
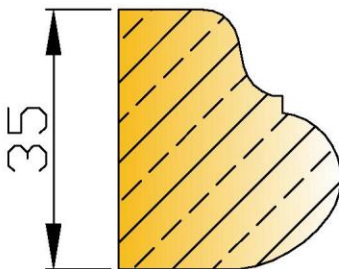

FK-68

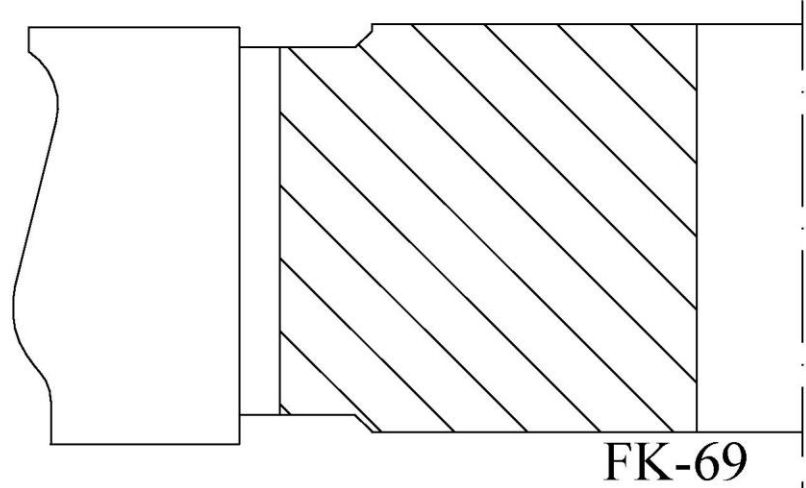
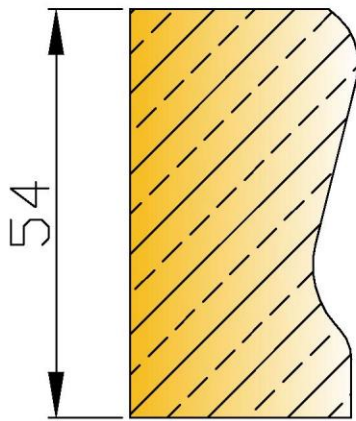

FK-69

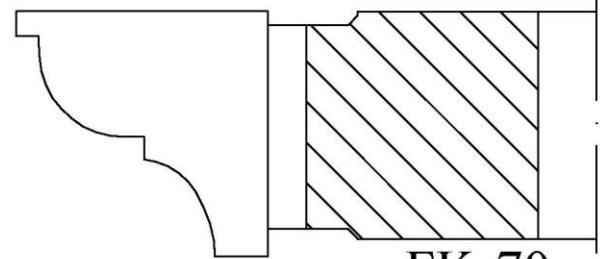
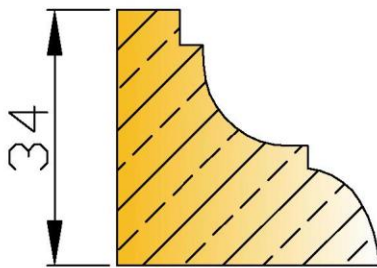

FK-70

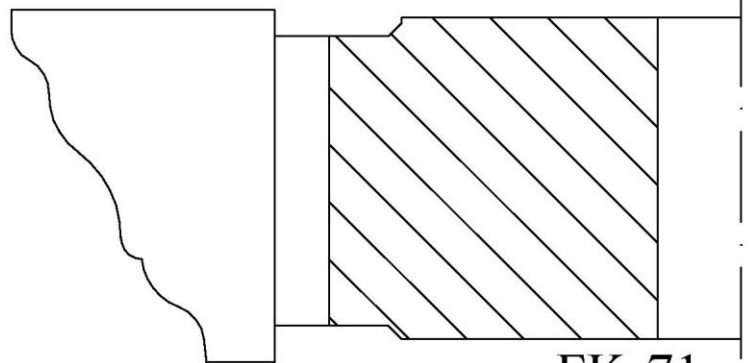
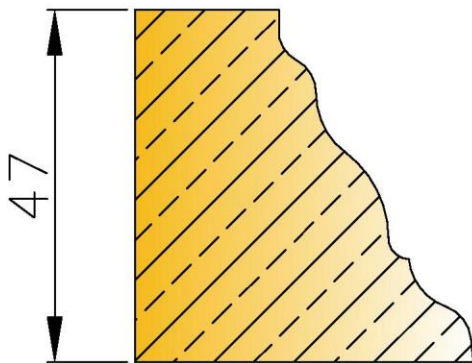

FK-71

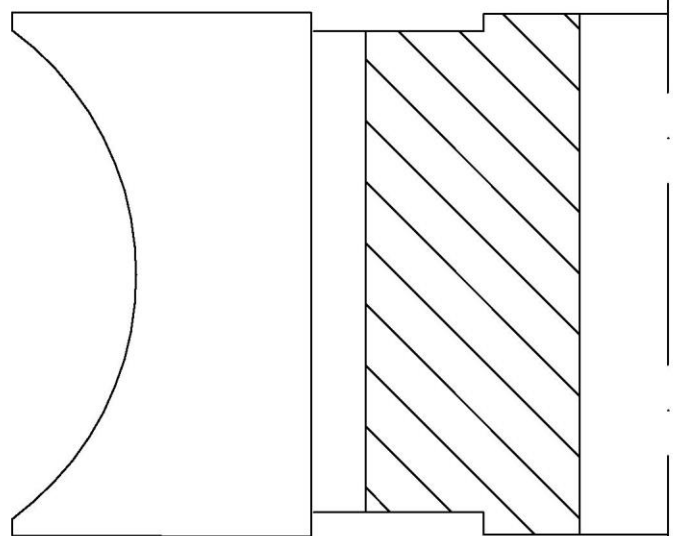
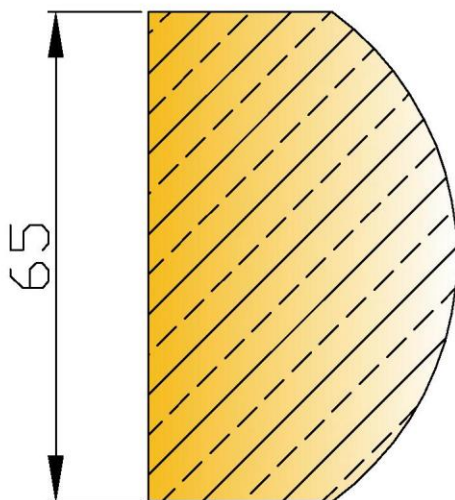

FK-72

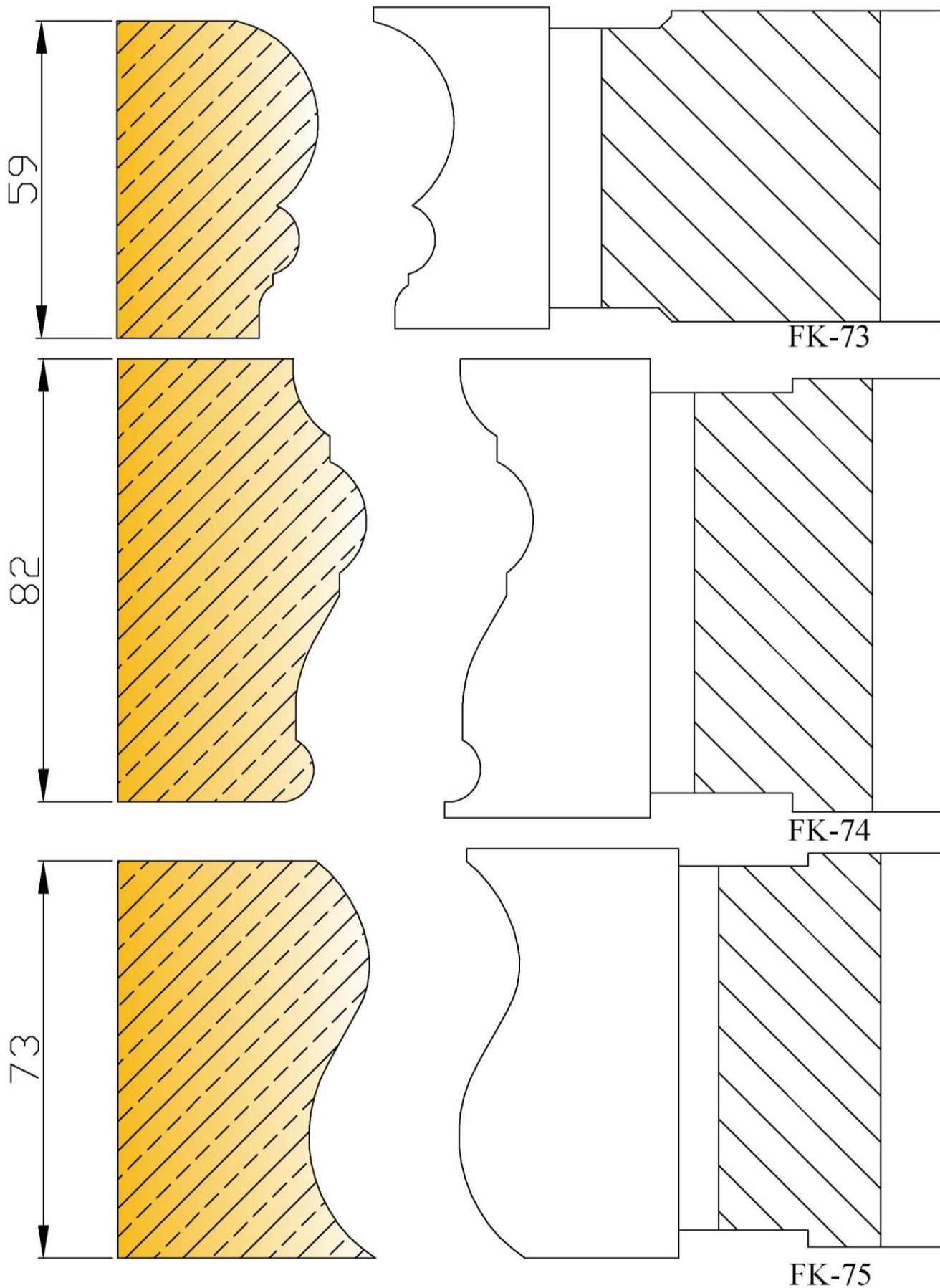

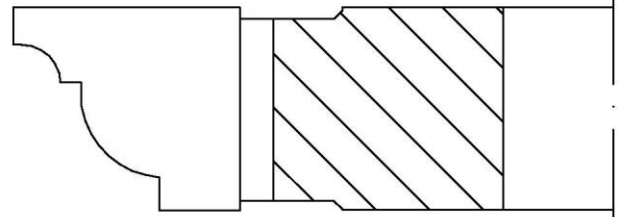
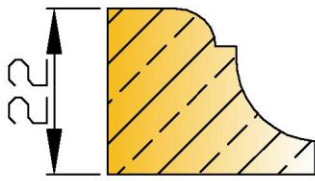
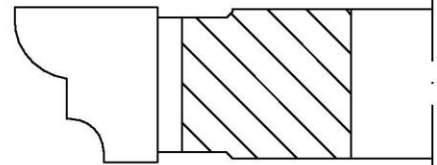
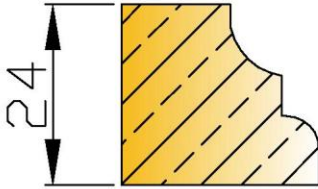
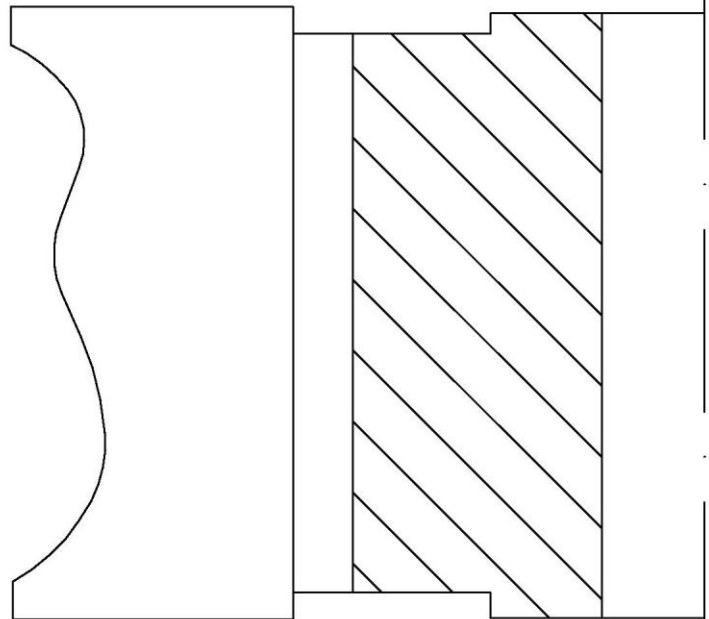
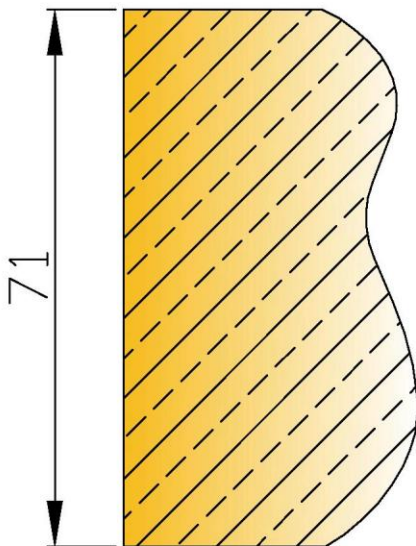
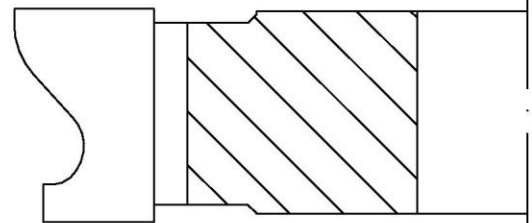
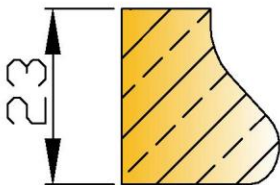
**FK-76****FK-77****FK-78****FK-79**

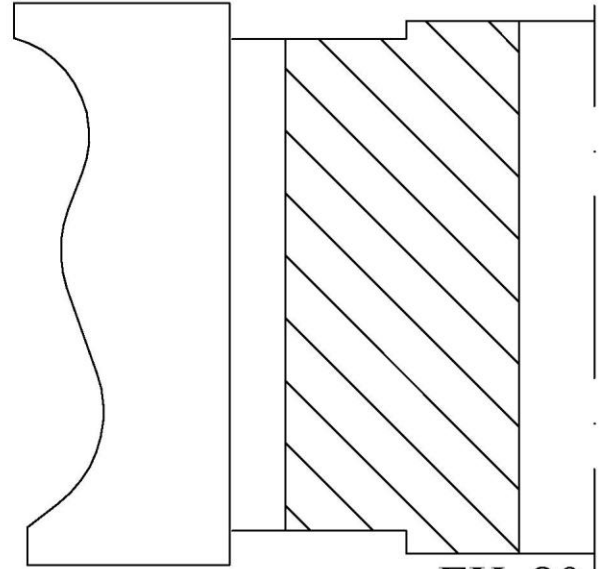
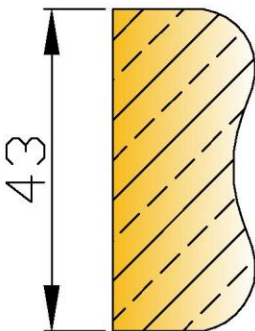
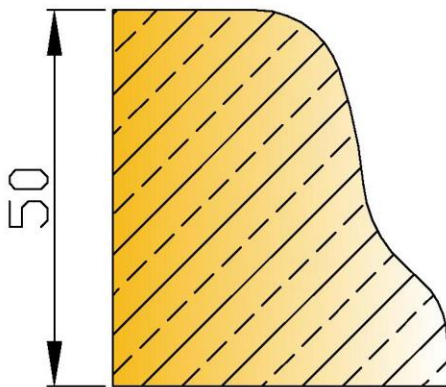
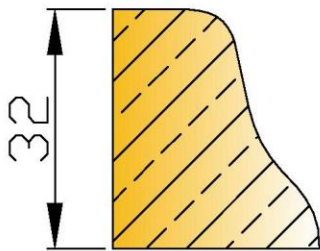
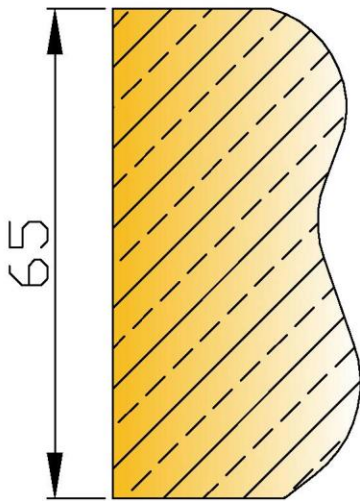

FK-80

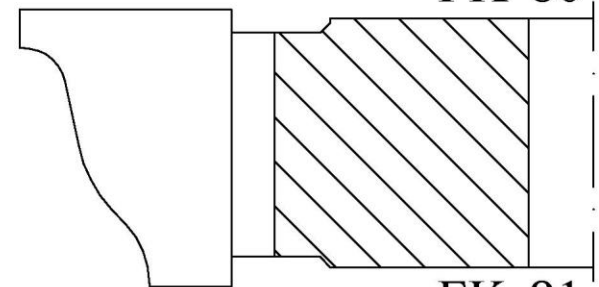

FK-81

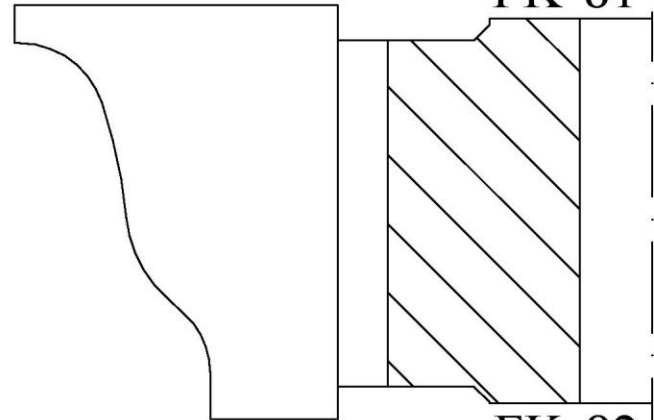

FK-82

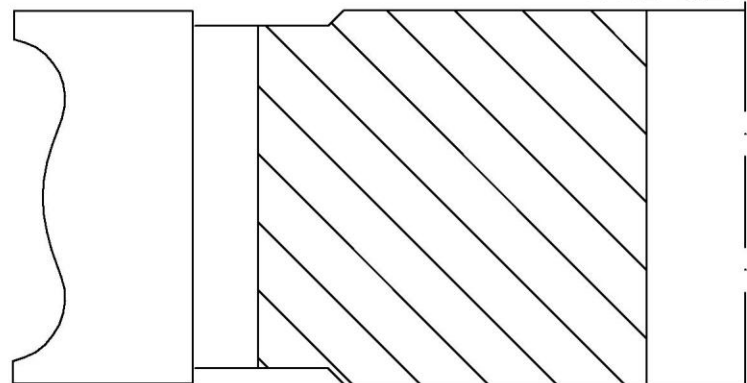

FK-83

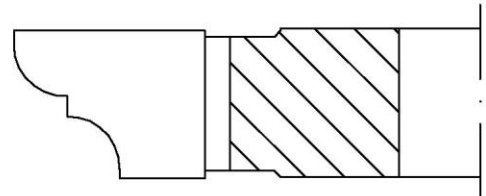
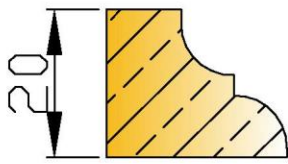

FK-84

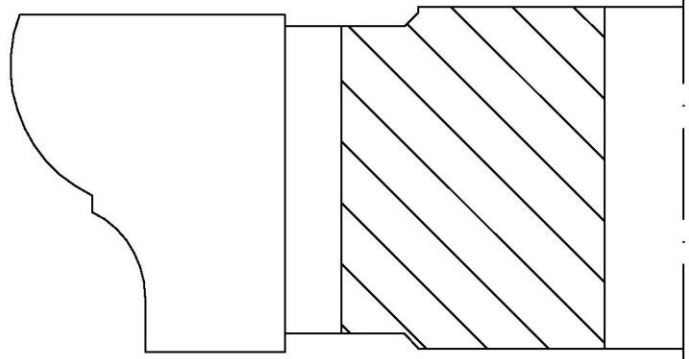
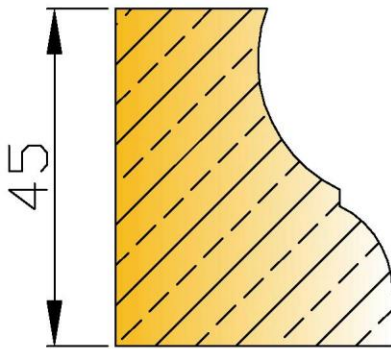

FK-85

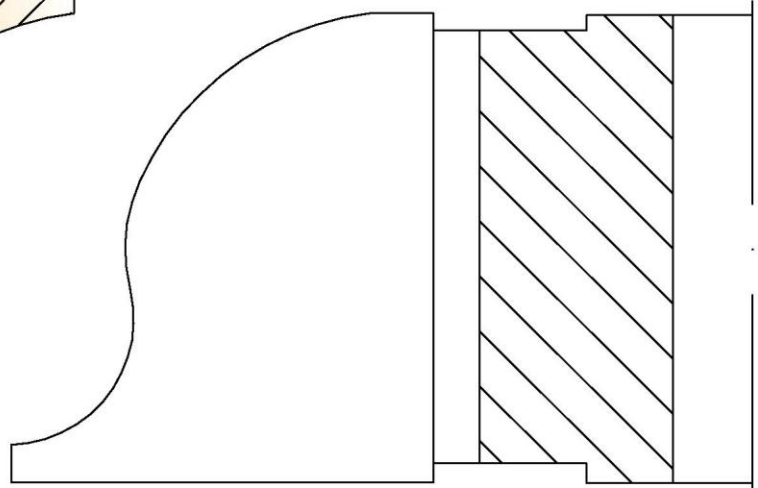
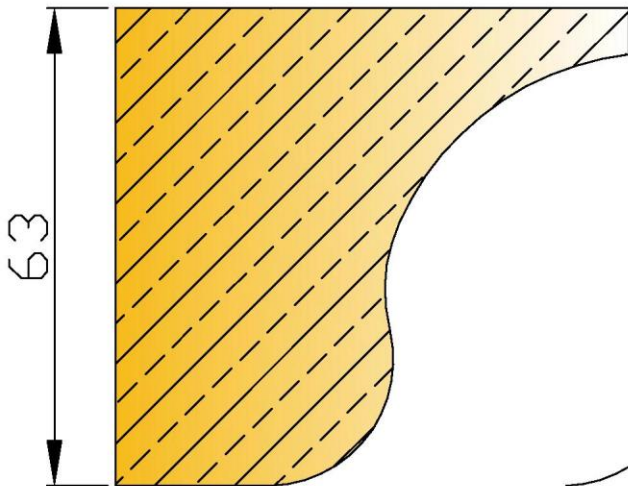

FK-86

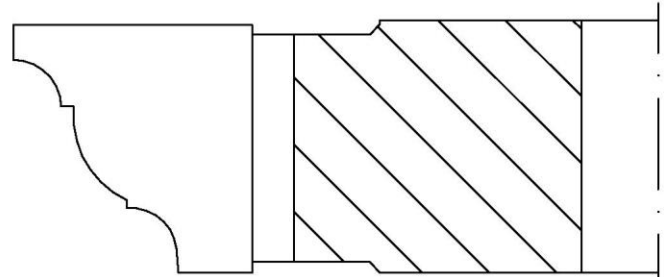
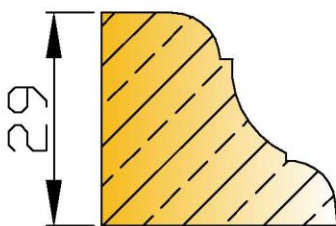

FK-87

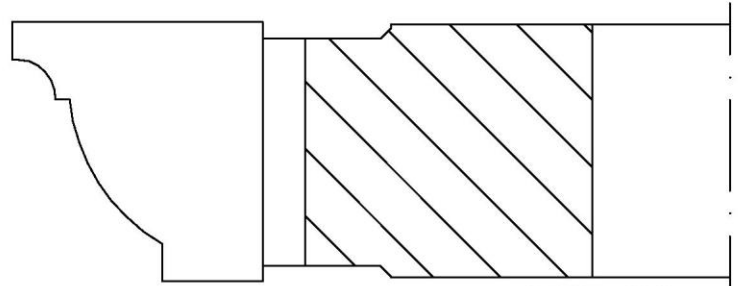
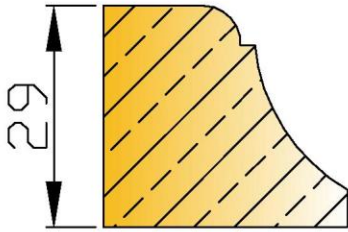

FK-88

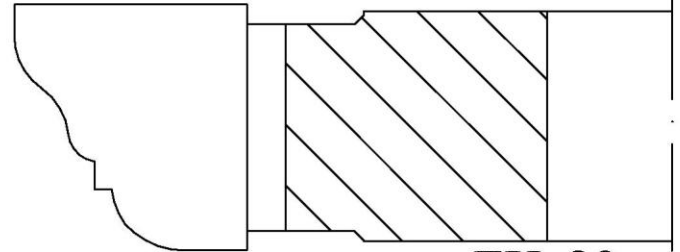
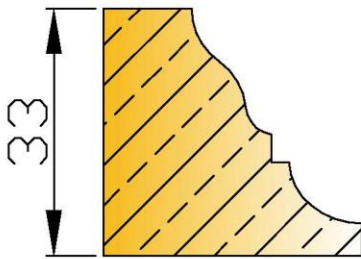

FK-89

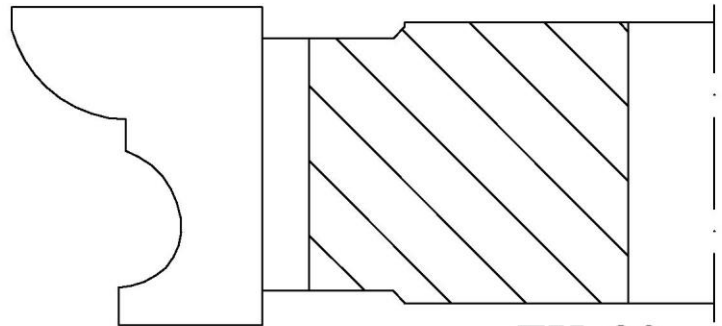
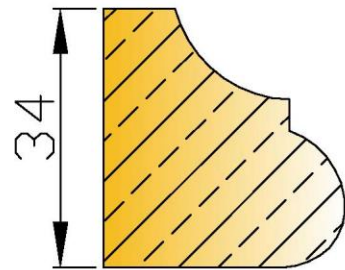

FK-90

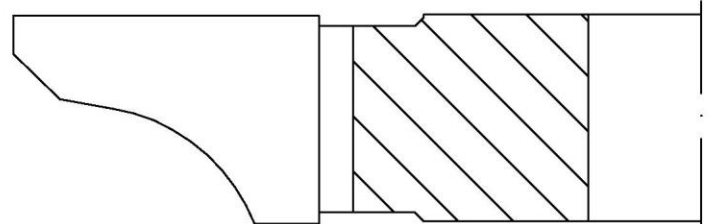
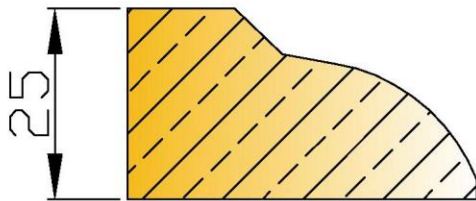

FK-91

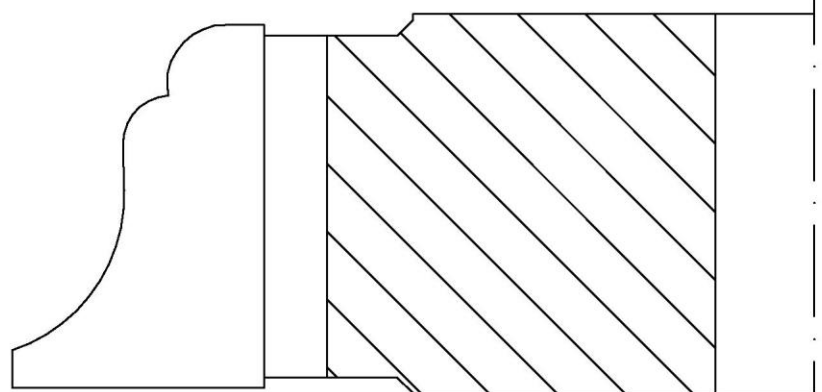
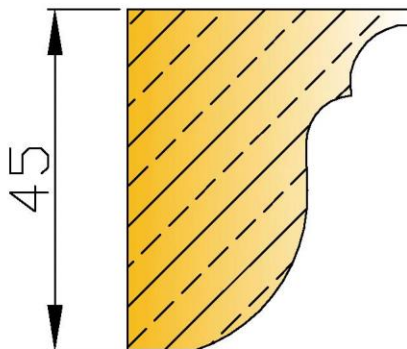

FK-92

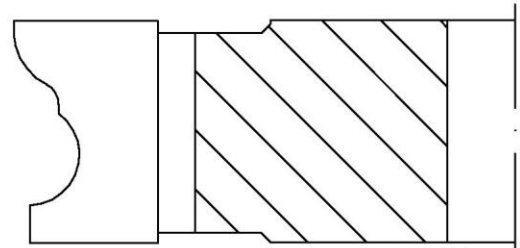
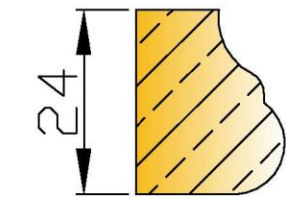

FK-93

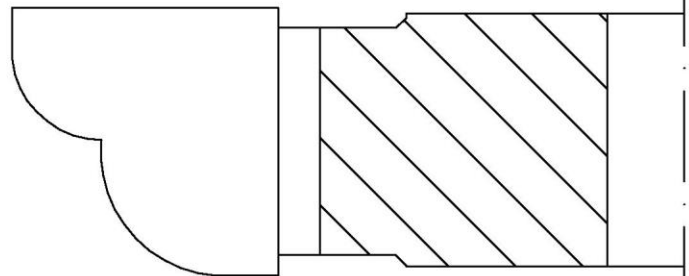
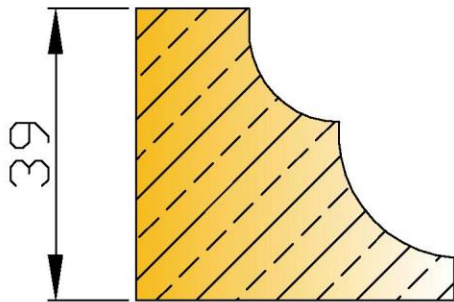

FK-94

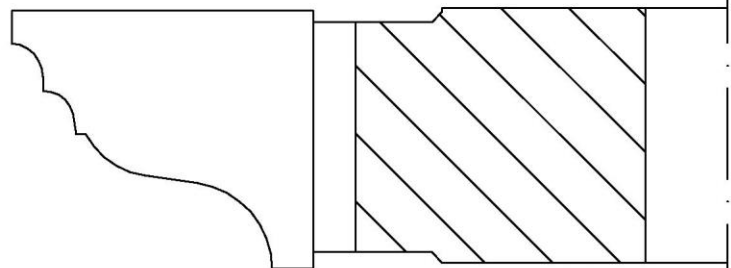
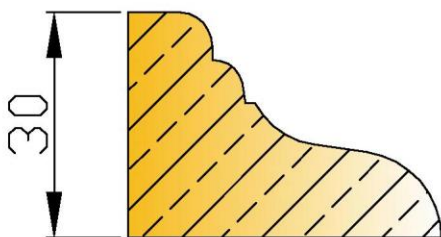

FK-95

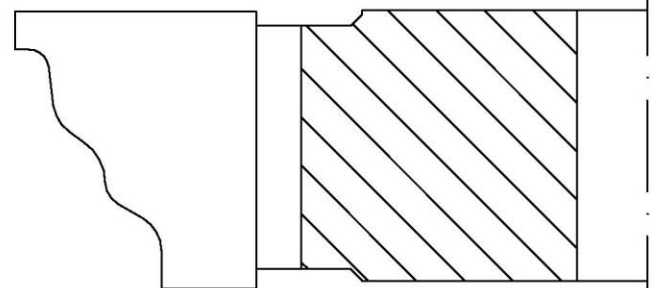
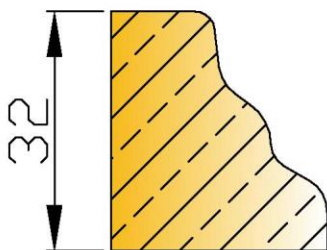

FK-96

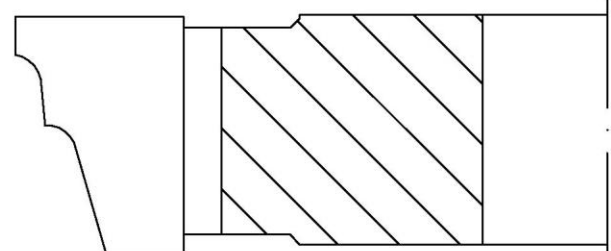
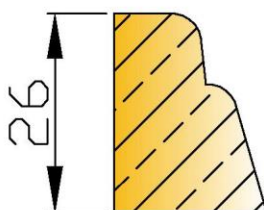

FK-97

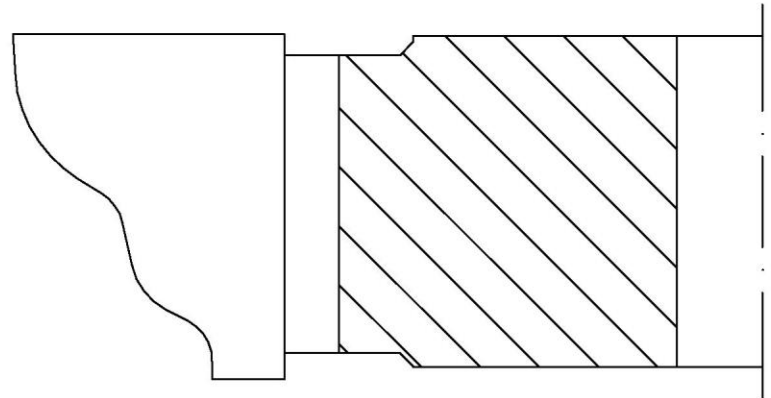
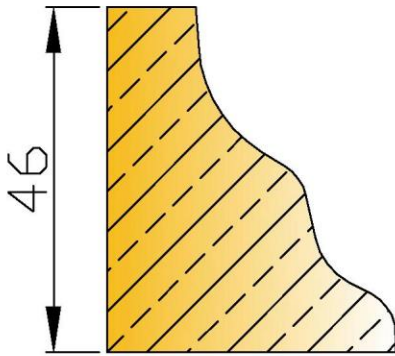

FK-98

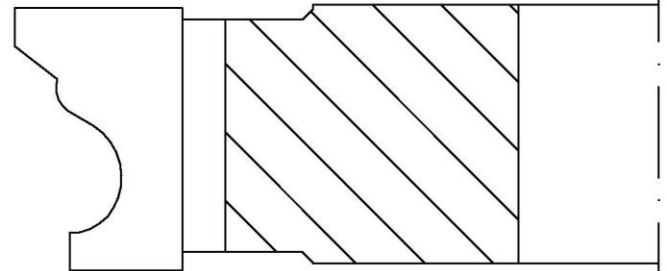
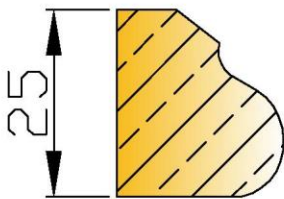

FK-99

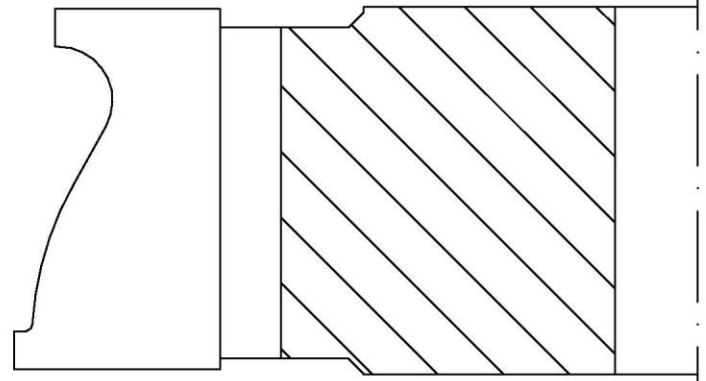
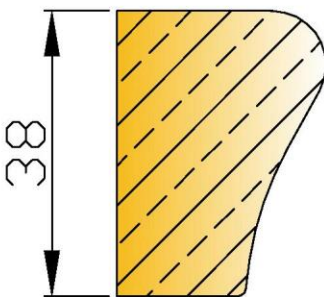

FK-100

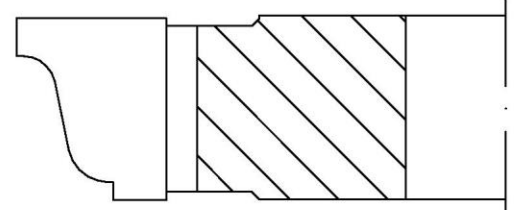

FK-101

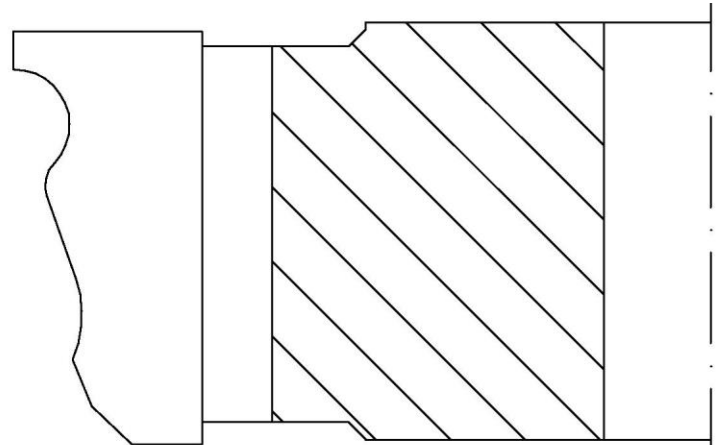
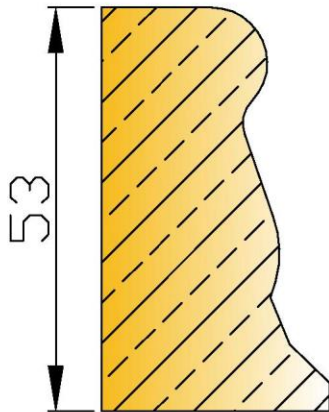

FK-102

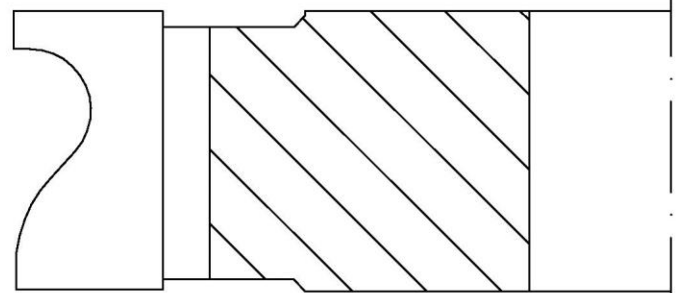
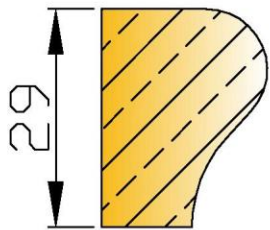

FK-103

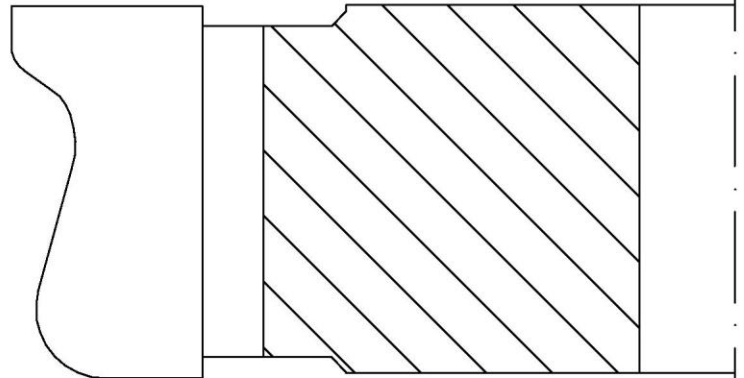
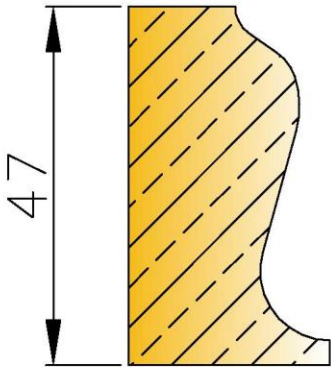

FK-104

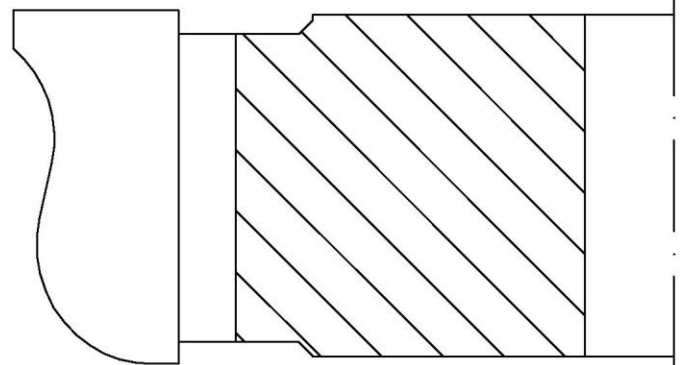
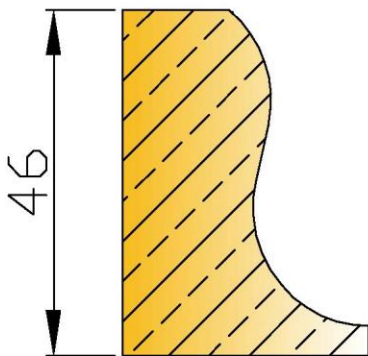

FK-105

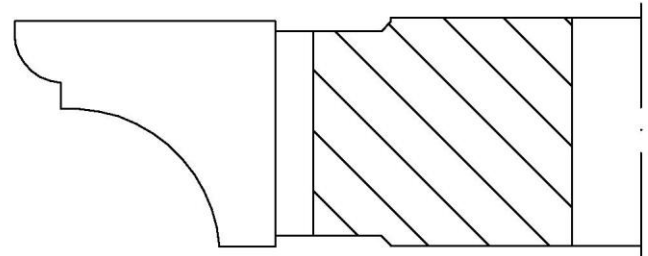
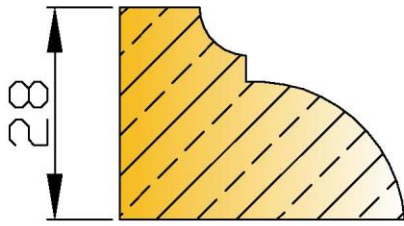

FK-106

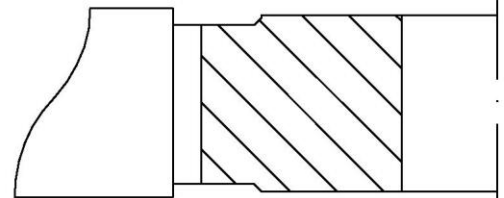
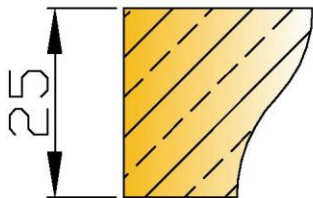

FK-107

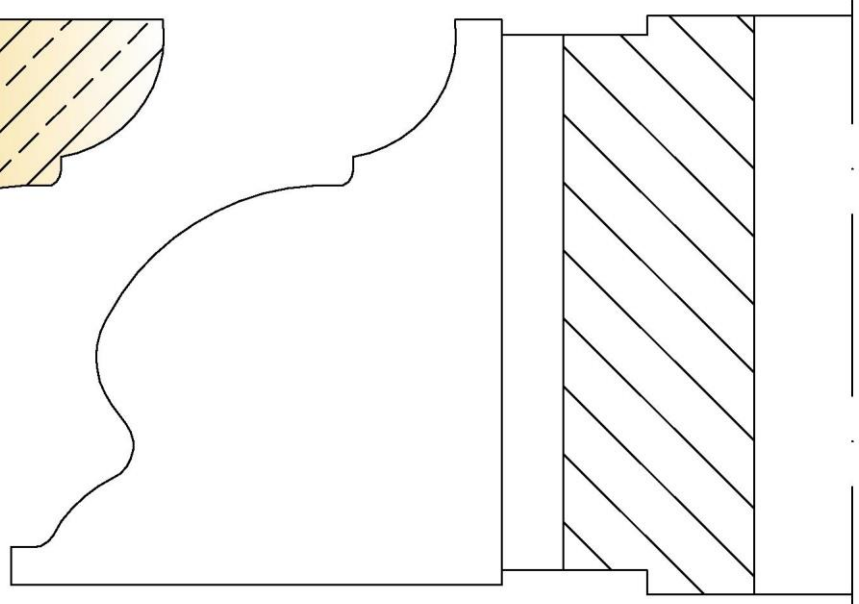

FK-108

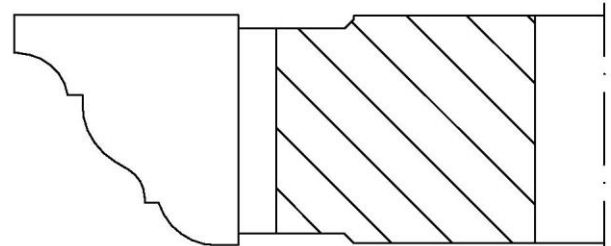
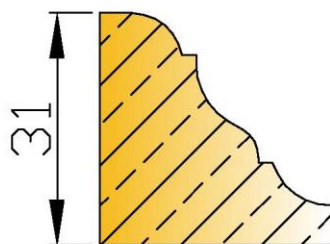

FK-109

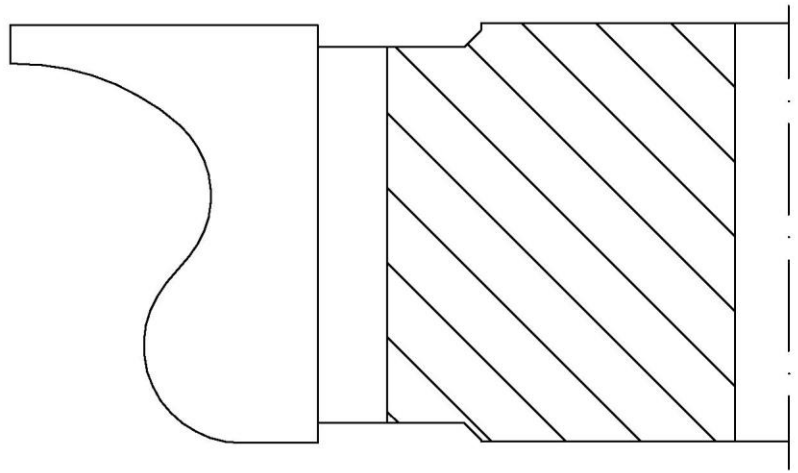
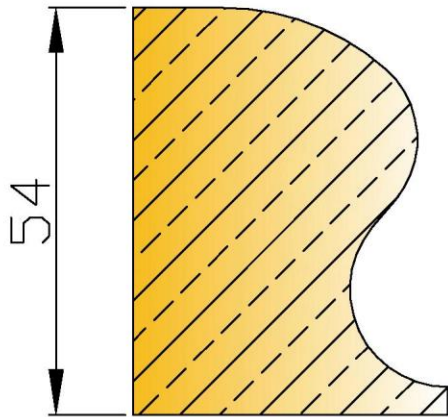

FK-110

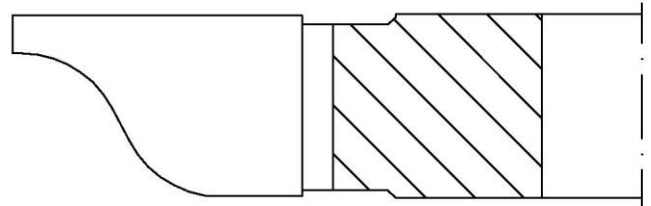
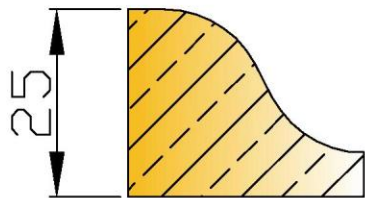

FK-111

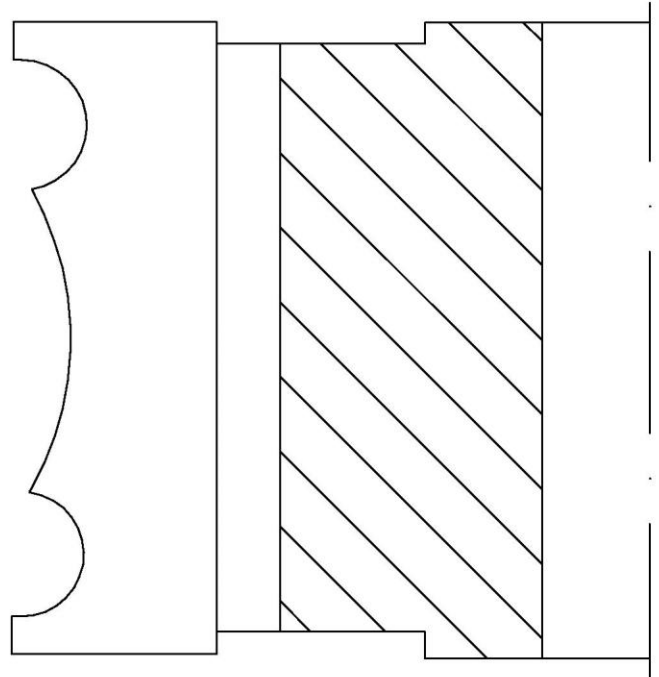
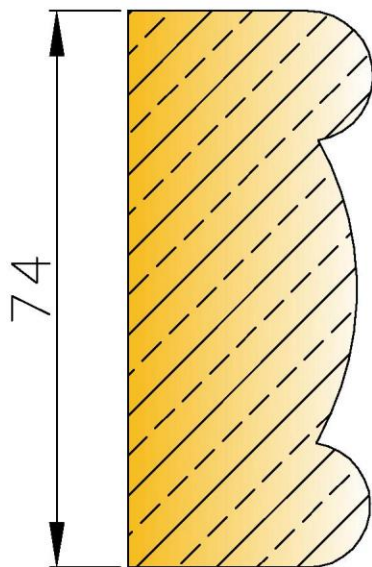

FK-112

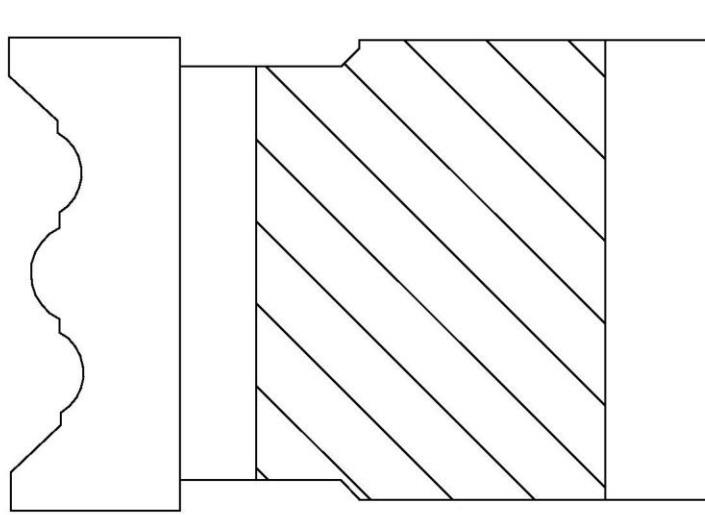
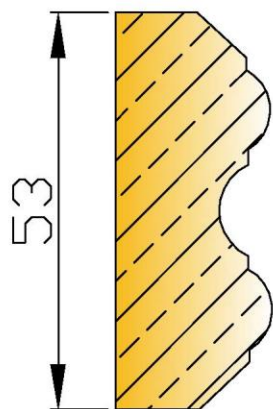

FK-113

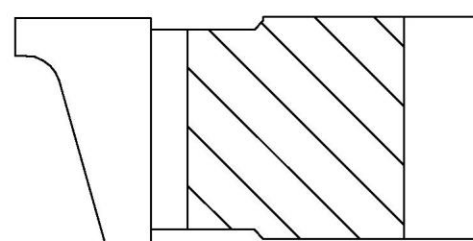
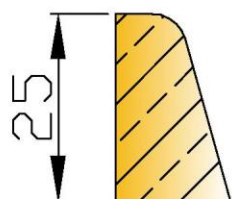

FK-114

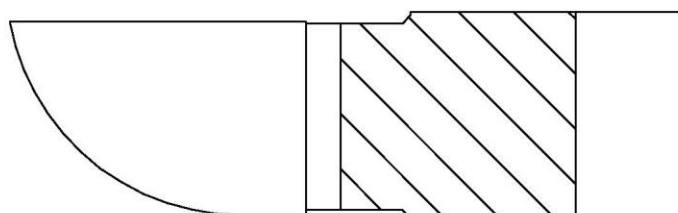
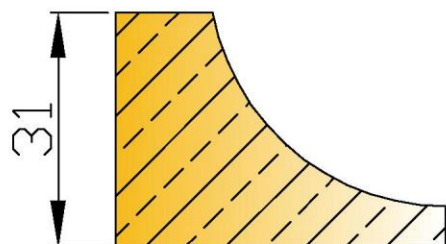

FK-115

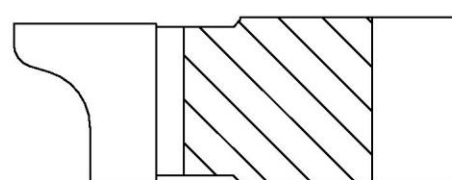
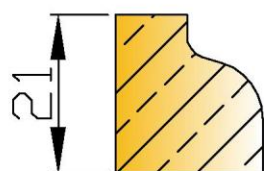

FK-116

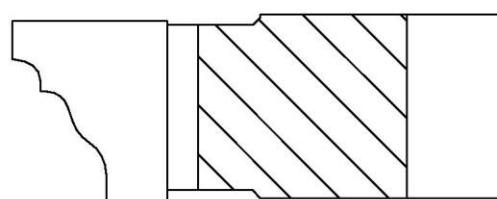
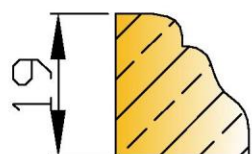

FK-117

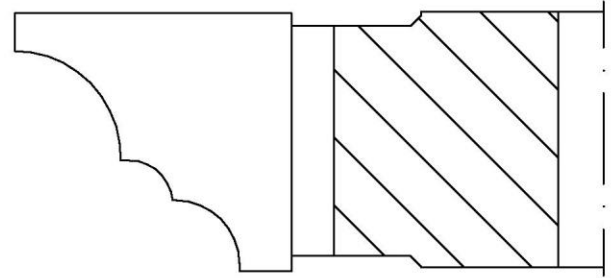
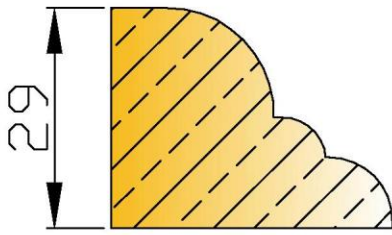

FK-118

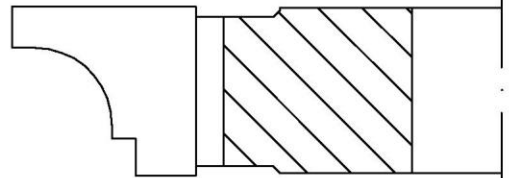
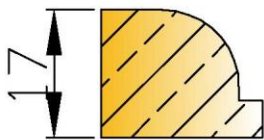

FK-119

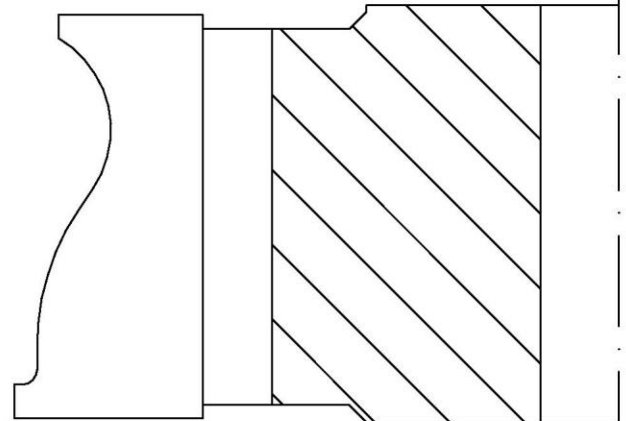
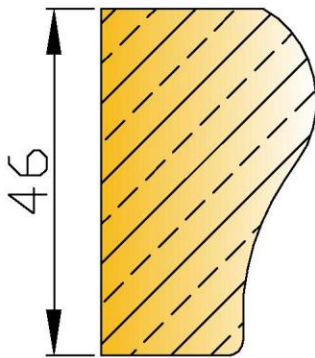

FK-120

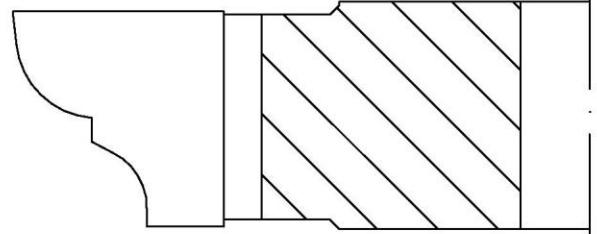
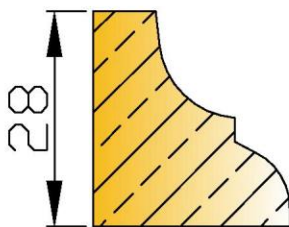

FK-121

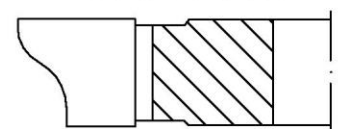
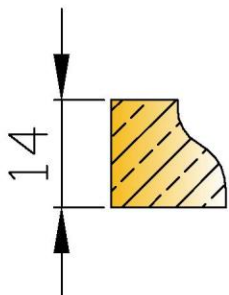

FK-122

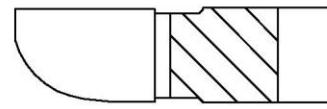
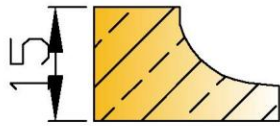
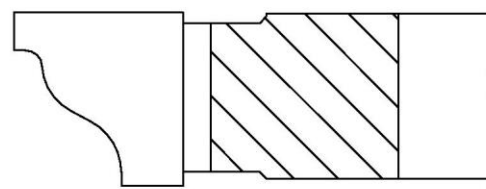
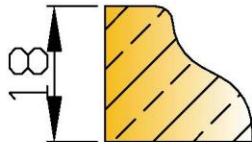
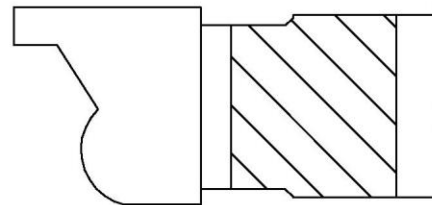
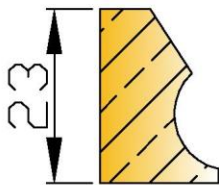
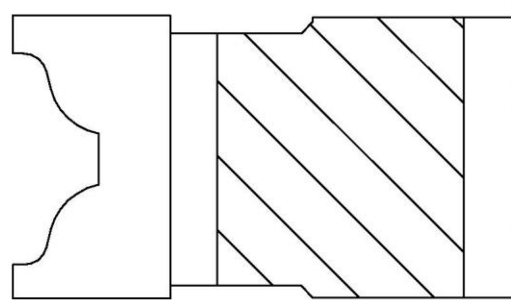
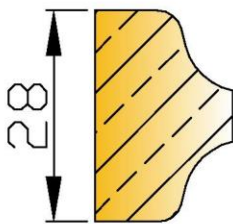
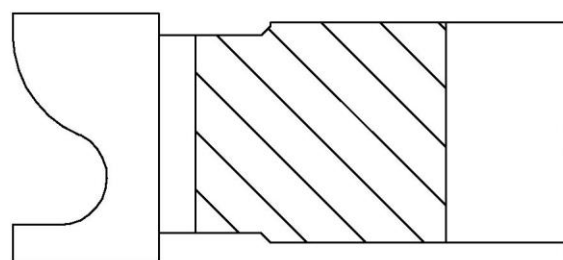
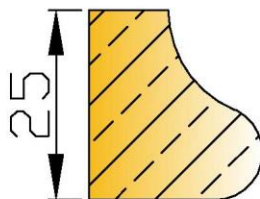
**FK-123****FK-124****FK-125****FK-126****FK-127**

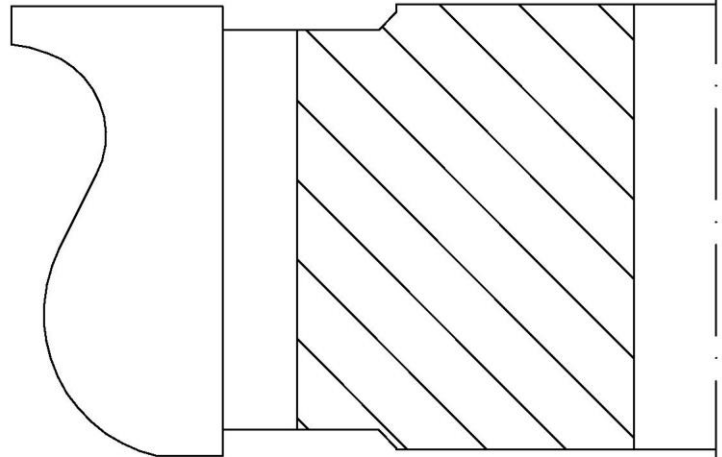
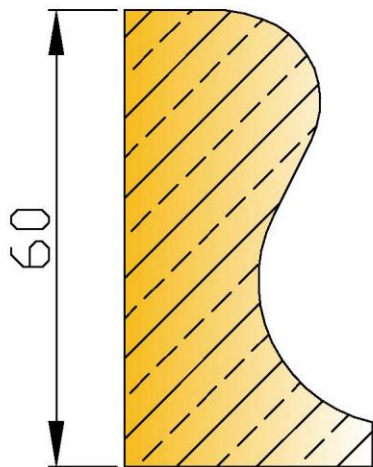

FK-128

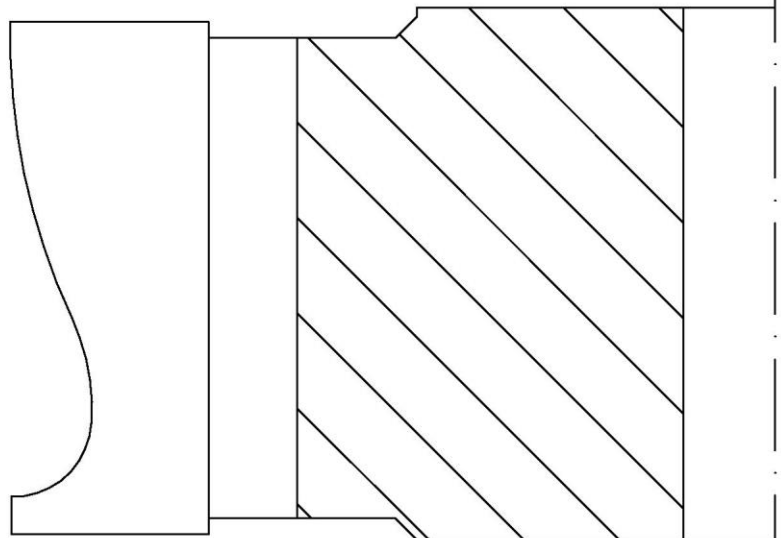
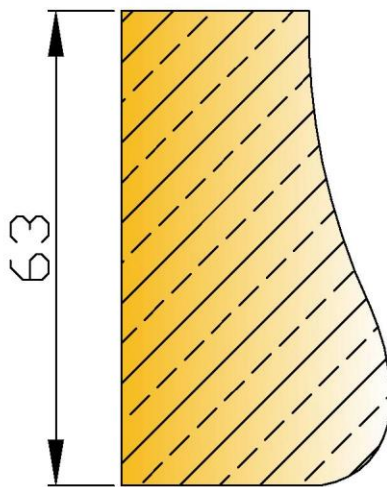

FK-129

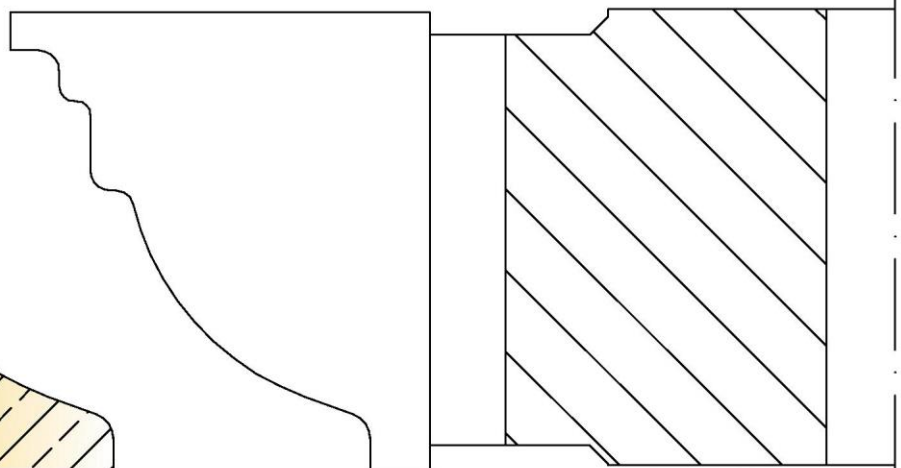
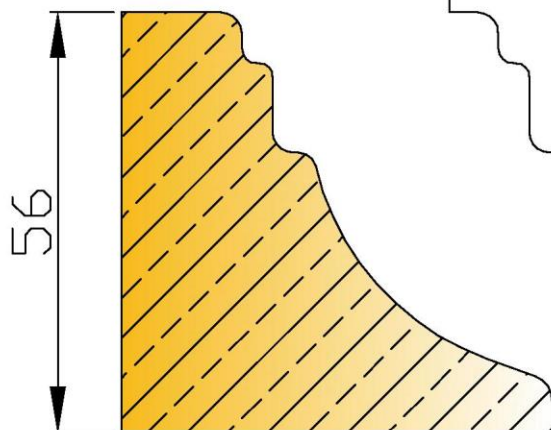

FK-130

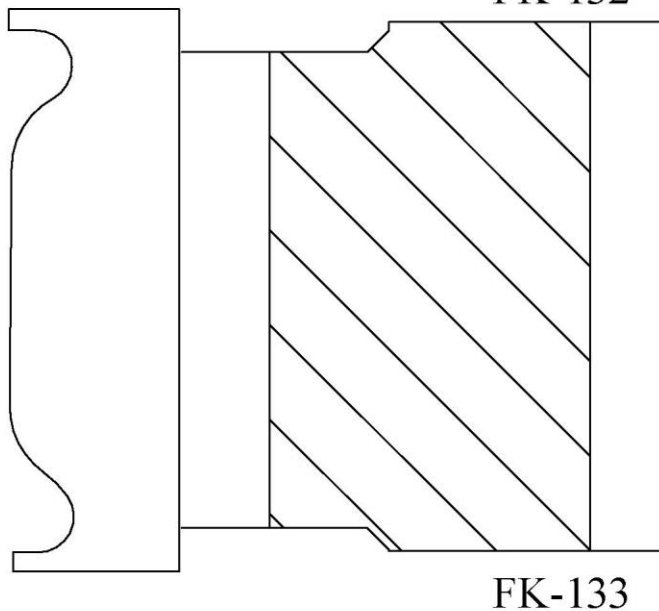
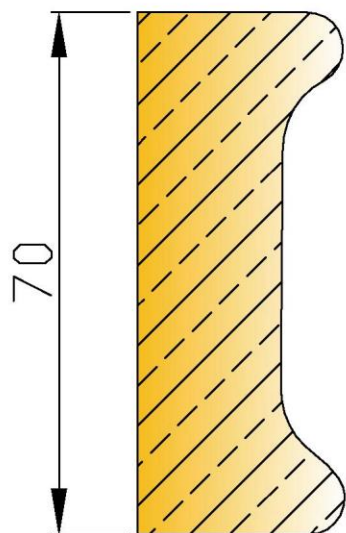
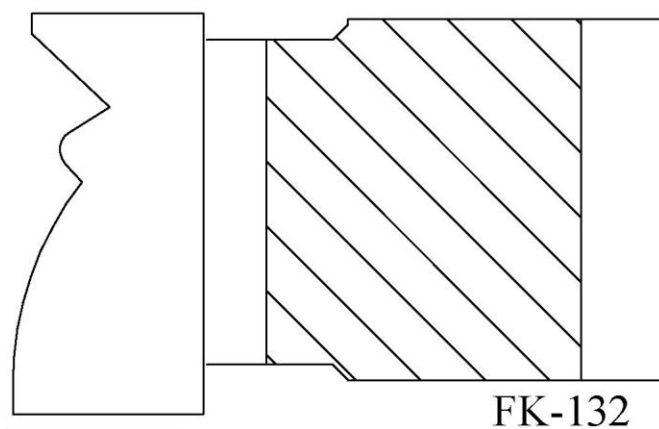
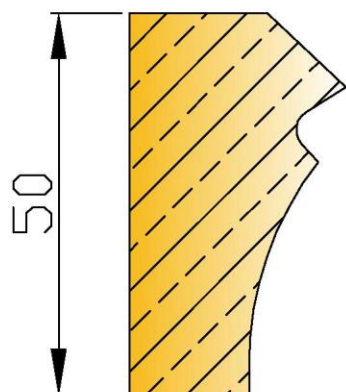
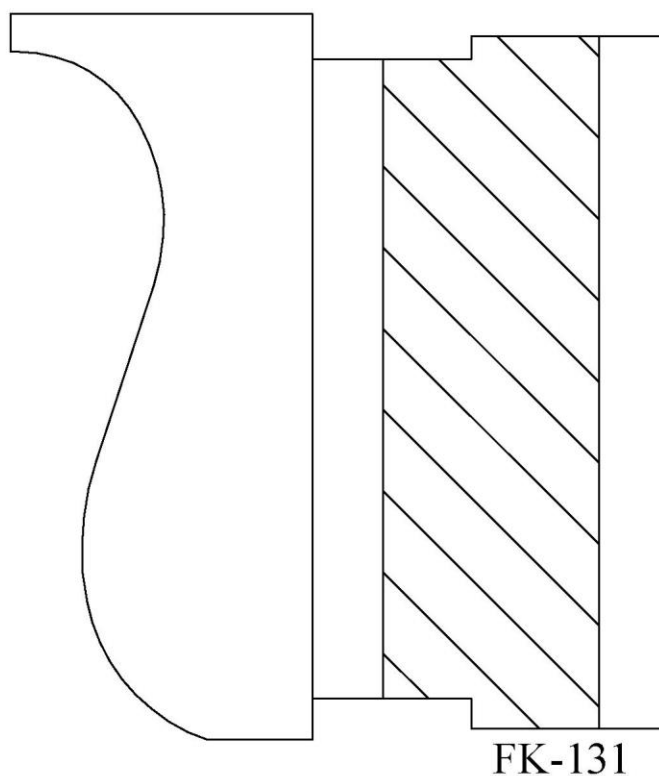
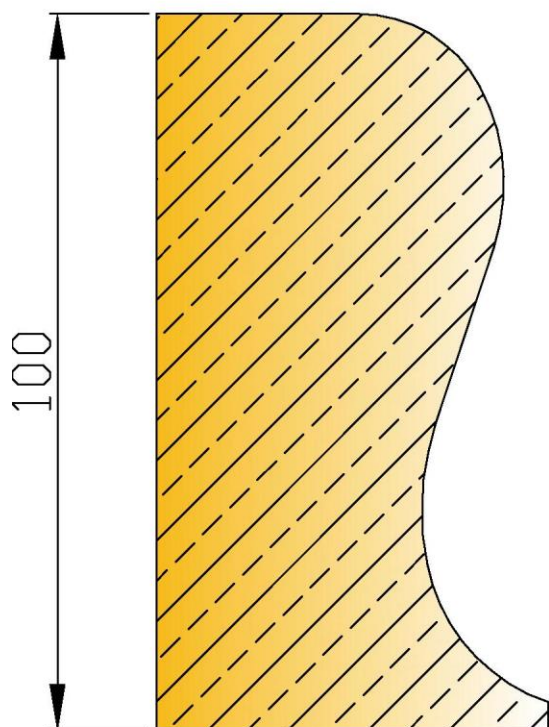

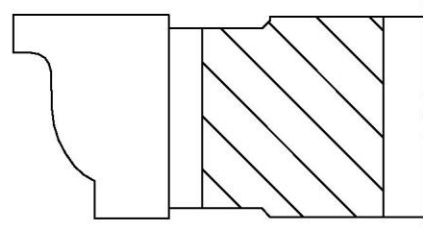
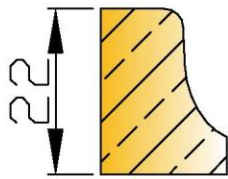
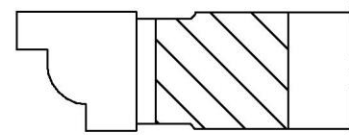
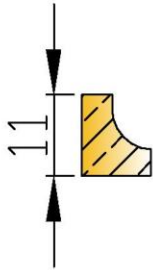
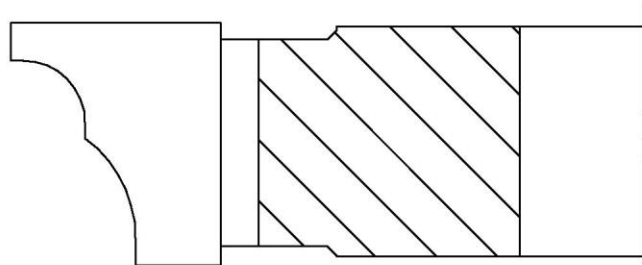
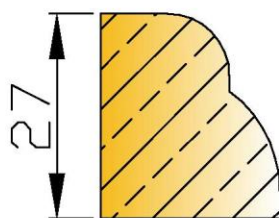
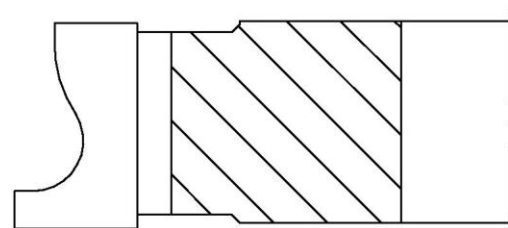
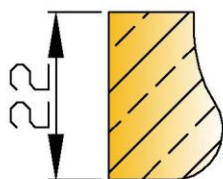
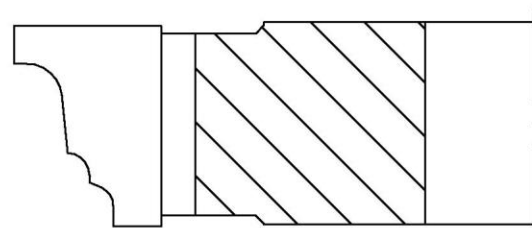
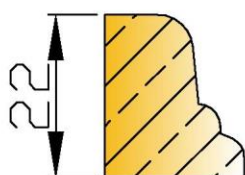
**FK-134****FK-135****FK-136****FK-137****FK-138**

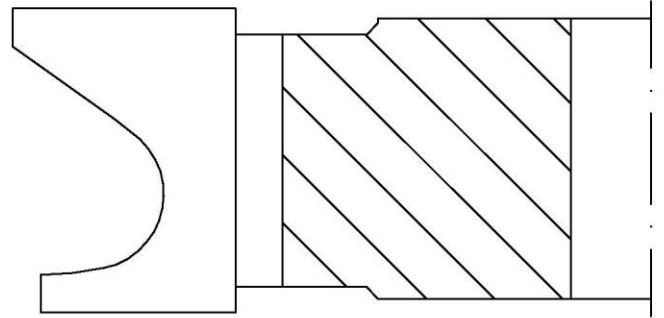
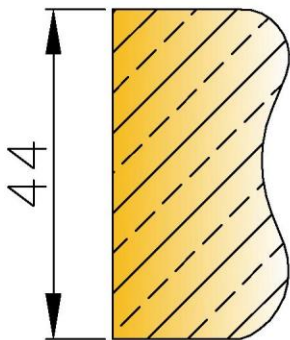
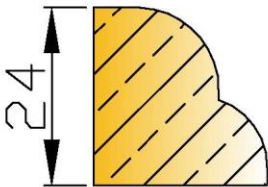
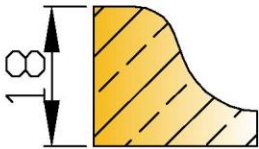
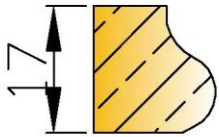
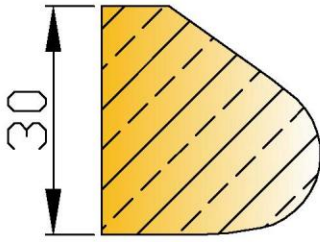

FK-139

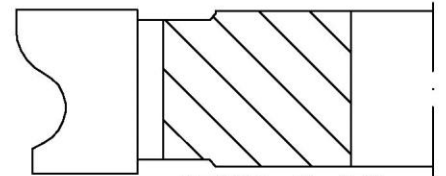

FK-140

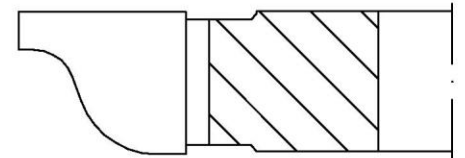

FK-141

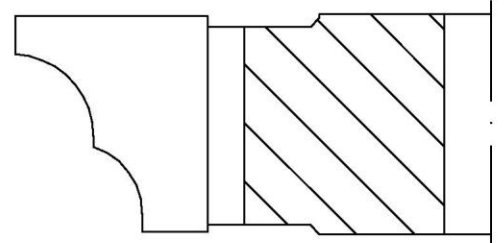

FK-142

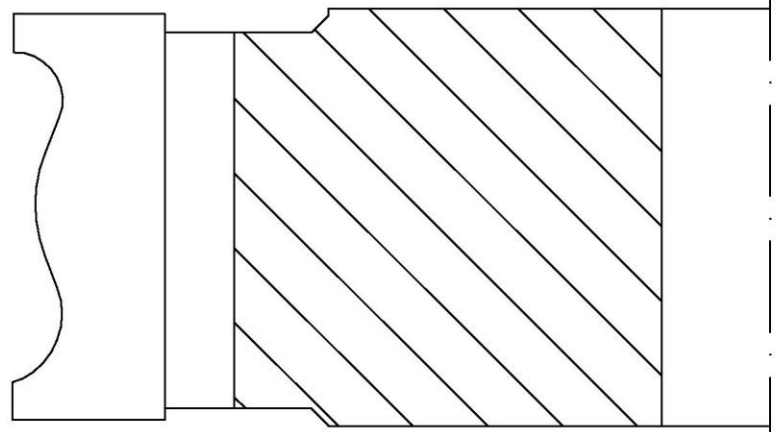

FK-143

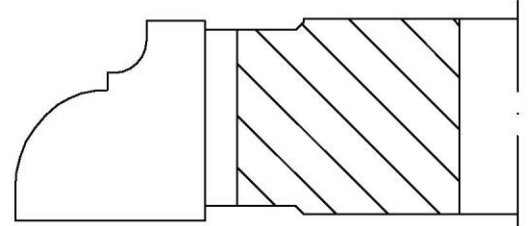
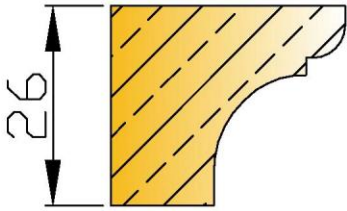

FK-144

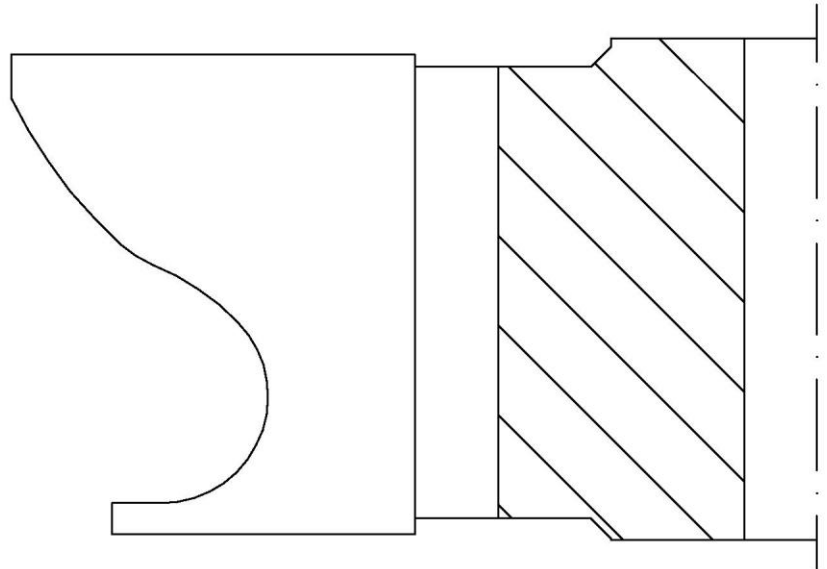
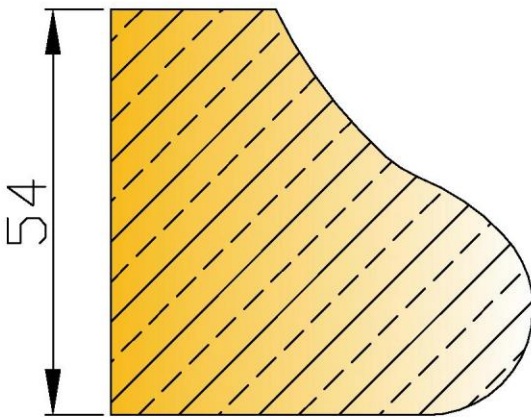

FK-145

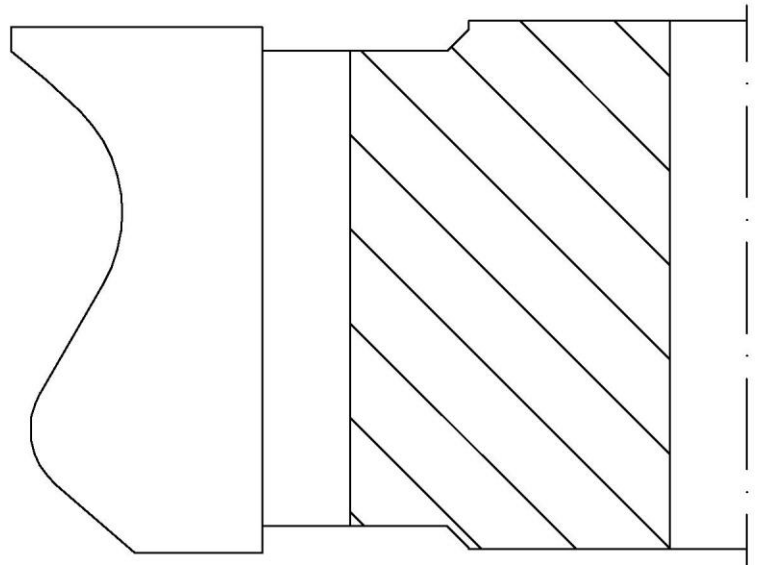
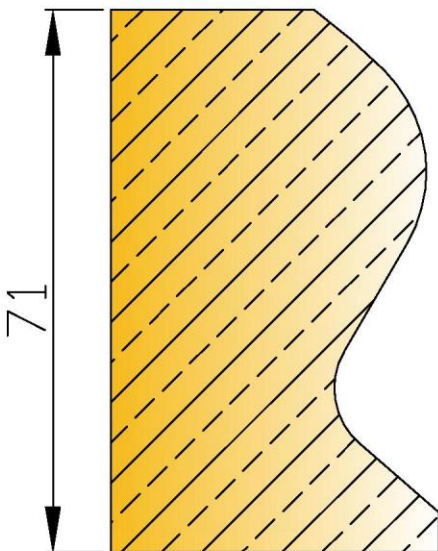

FK-146

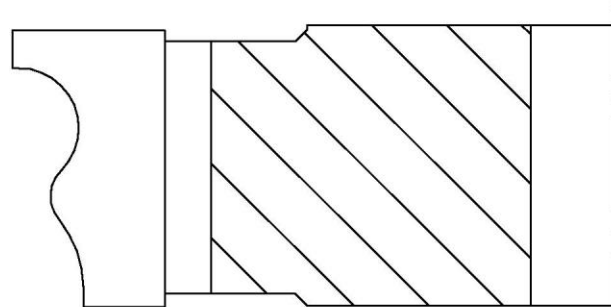
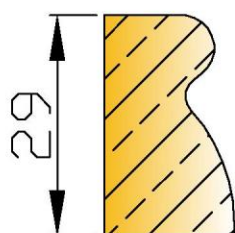
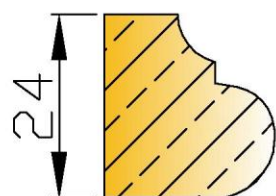
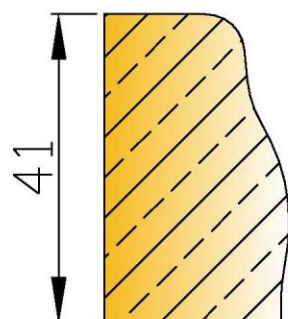
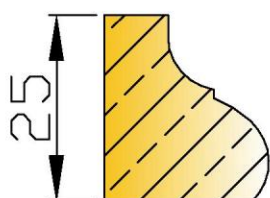
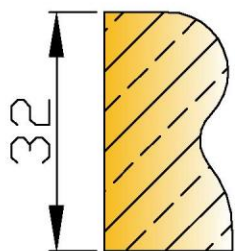

FK-147

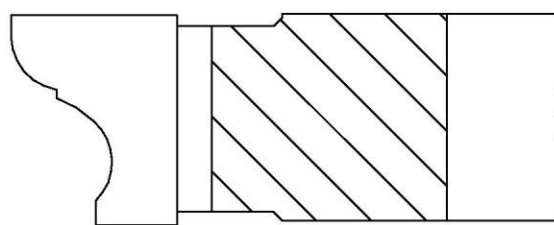

FK-148

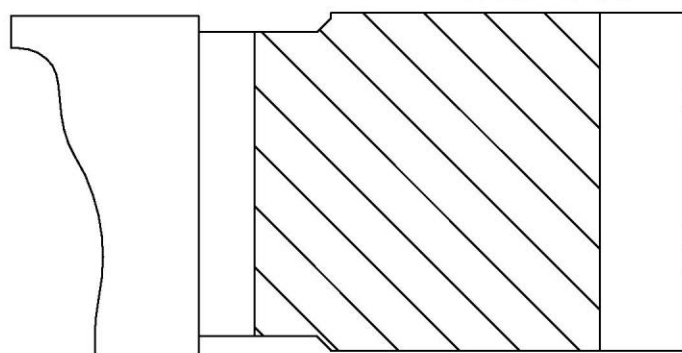

FK-149

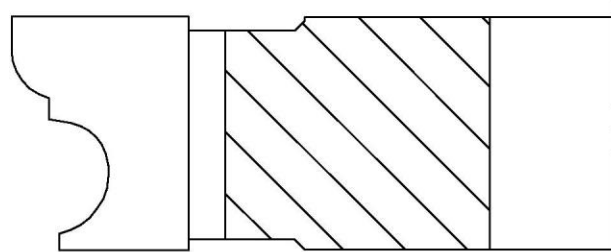

FK-150

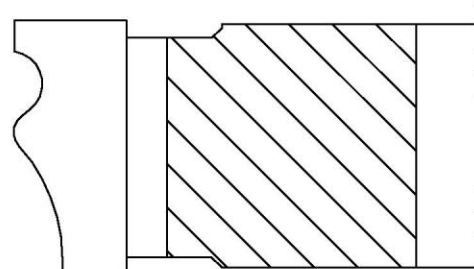

FK-151

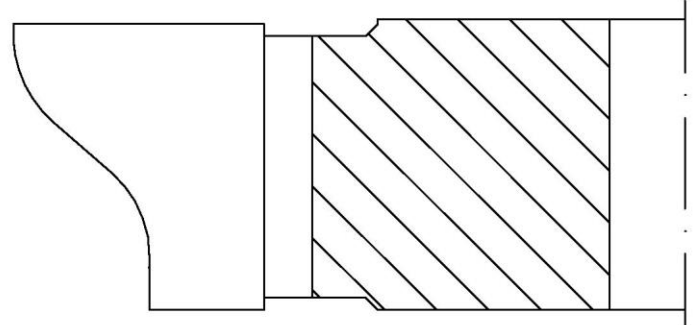
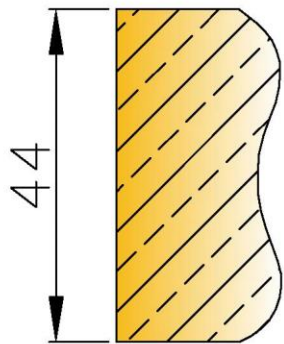
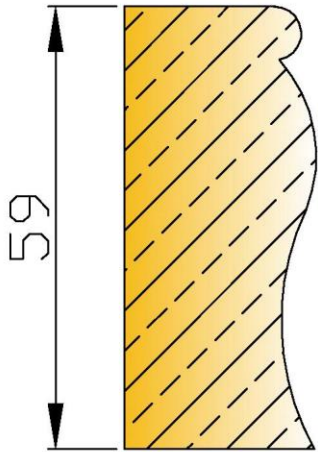
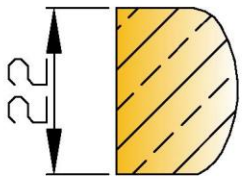
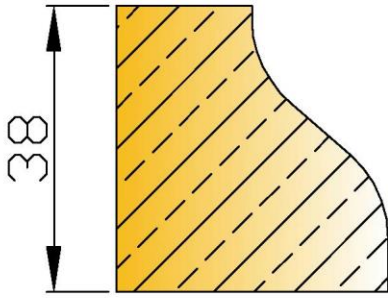

FK-152

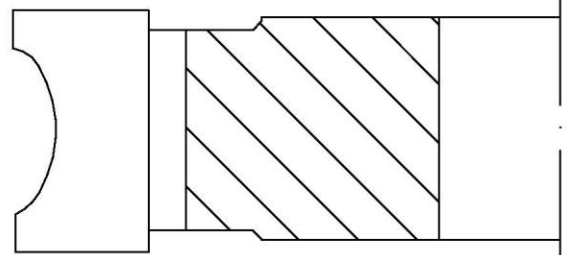

FK-153

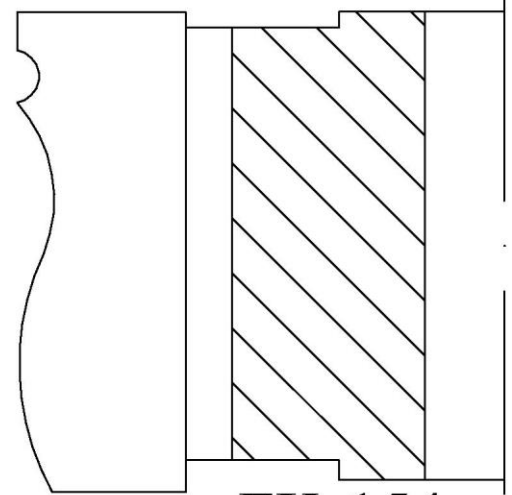

FK-154

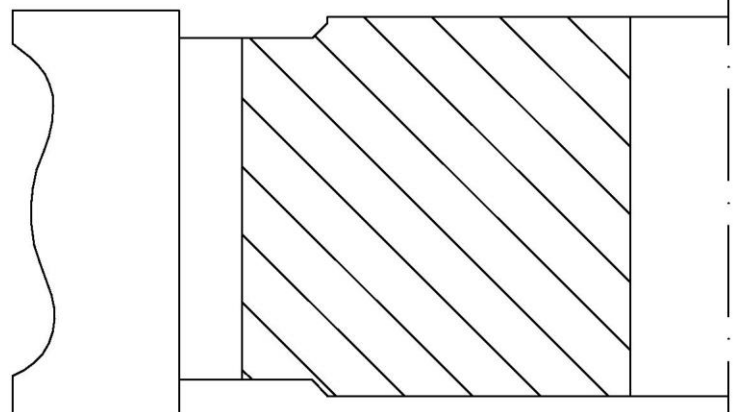

FK-155

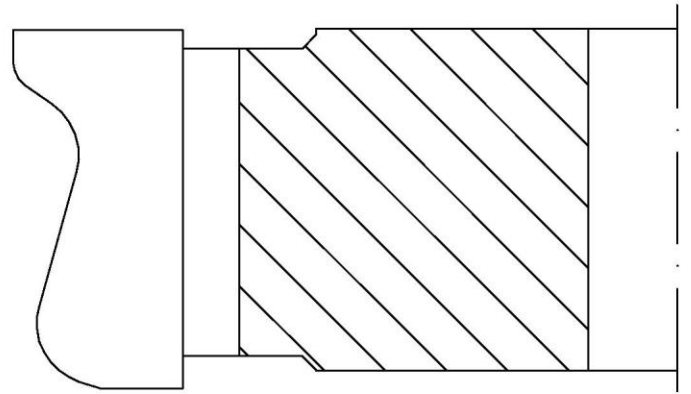
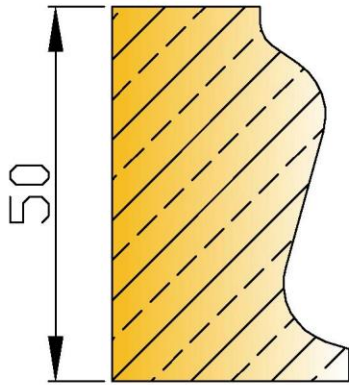

FK-156

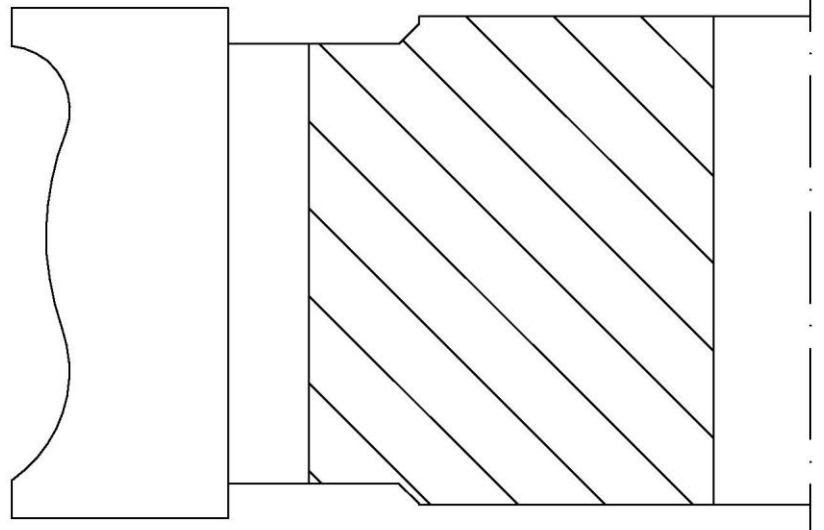
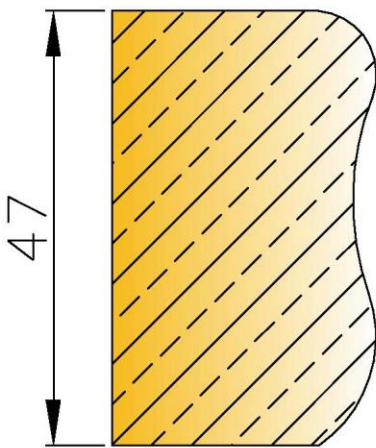

FK-157

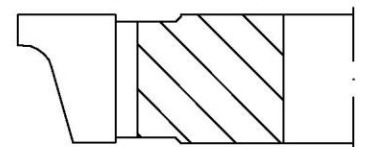
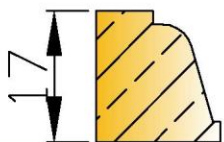

FK-158

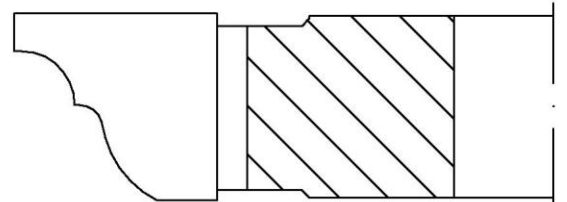
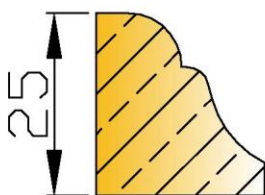

FK-159

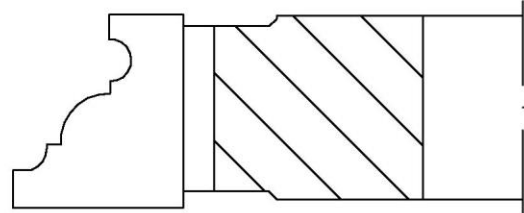
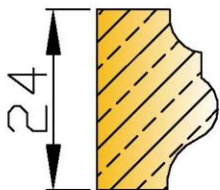
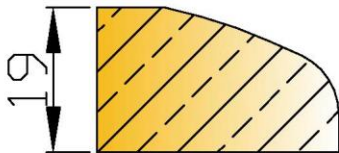
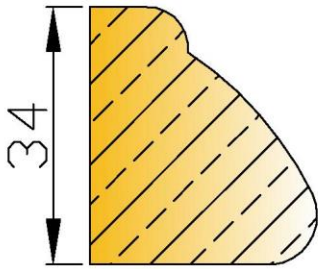
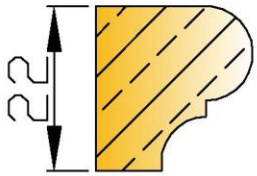
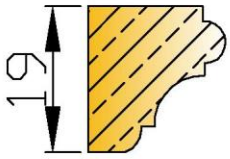

FK-160

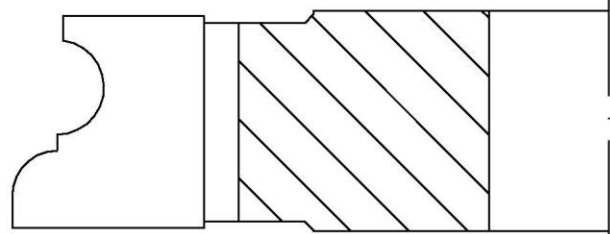

FK-161

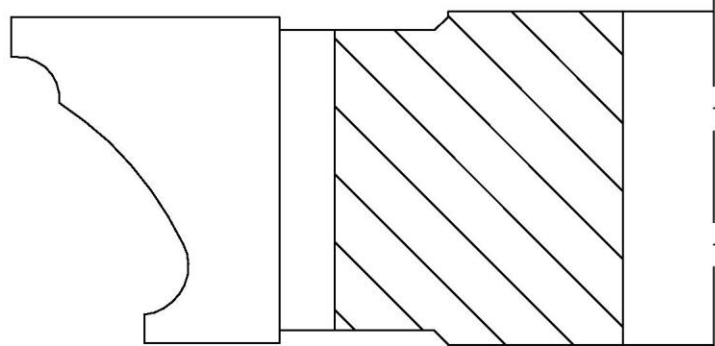

FK-162

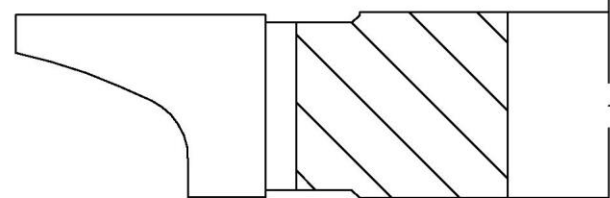

FK-163

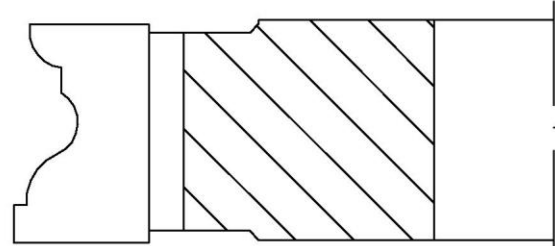

FK-164

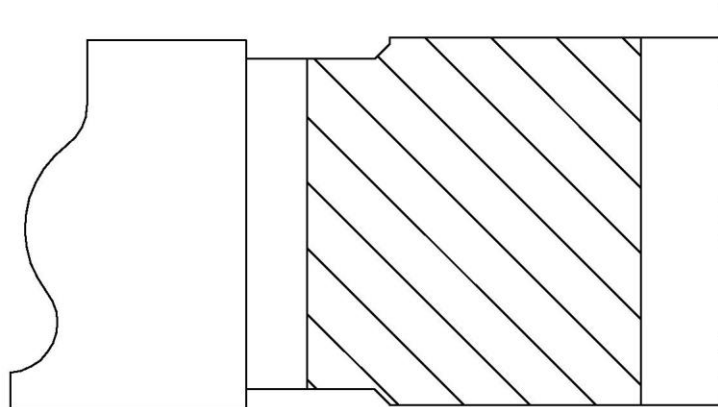
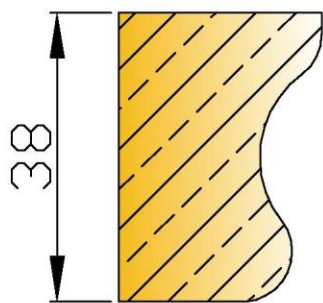

FK-165

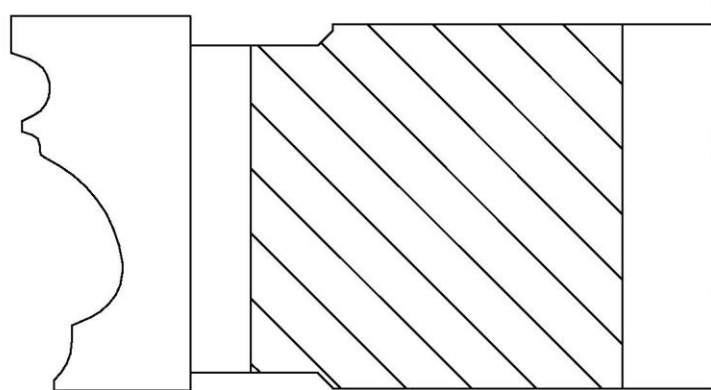
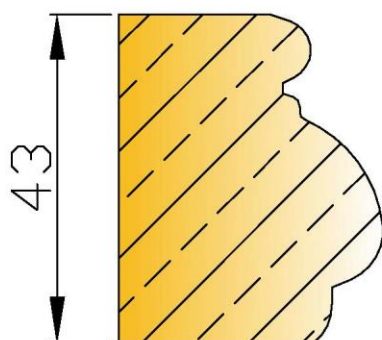

FK-166

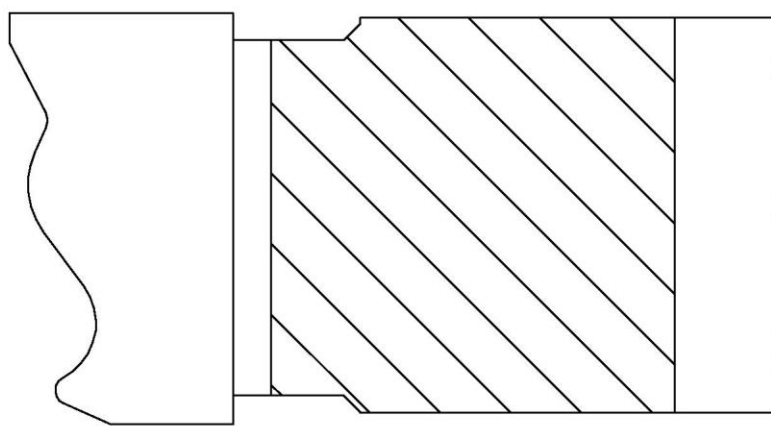
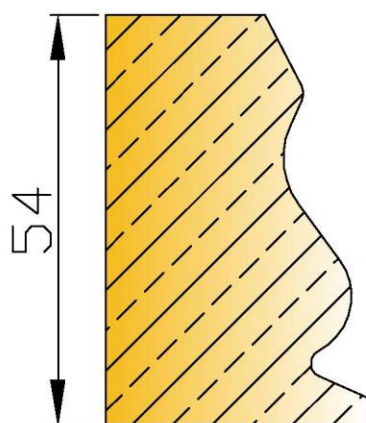

FK-167

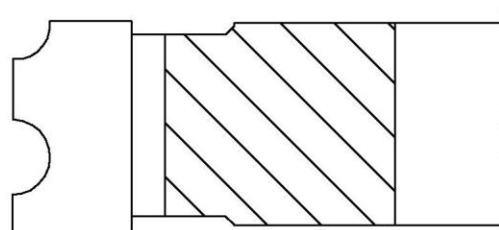
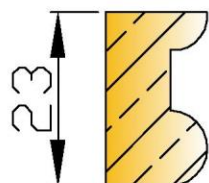

FK-168

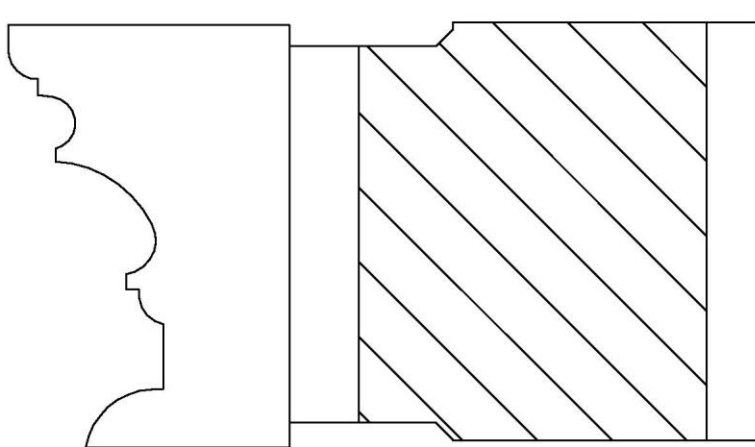
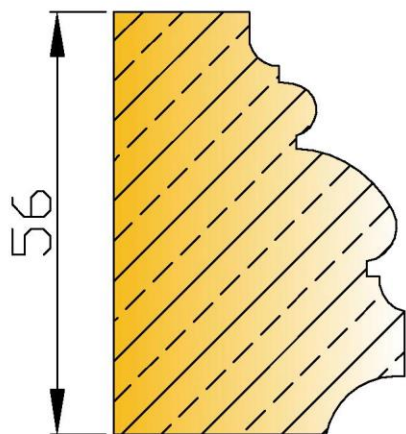

FK-169

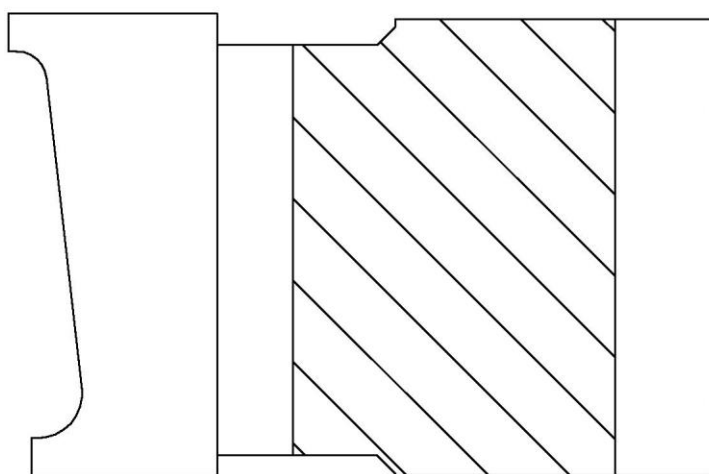
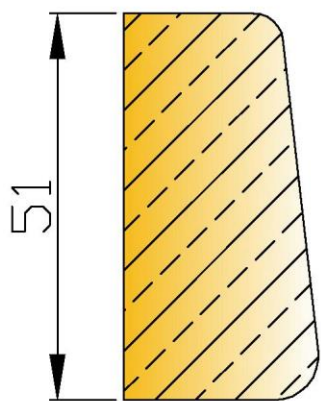

FK-170

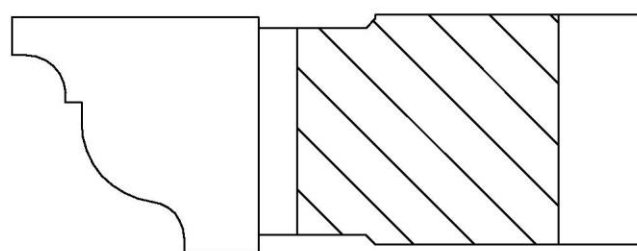
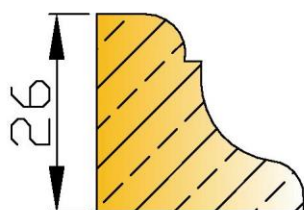

FK-171

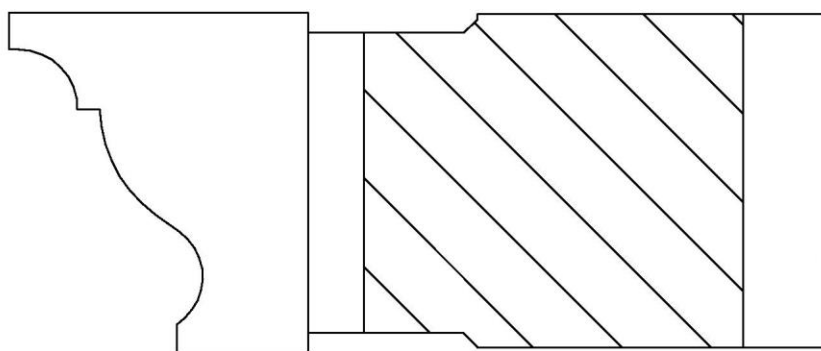
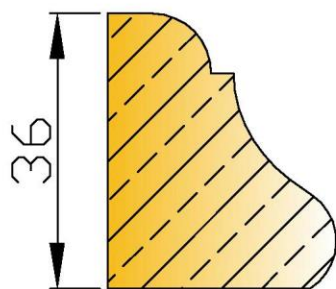

FK-172

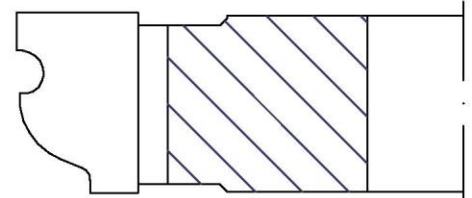
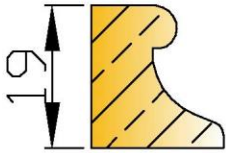

FK-173

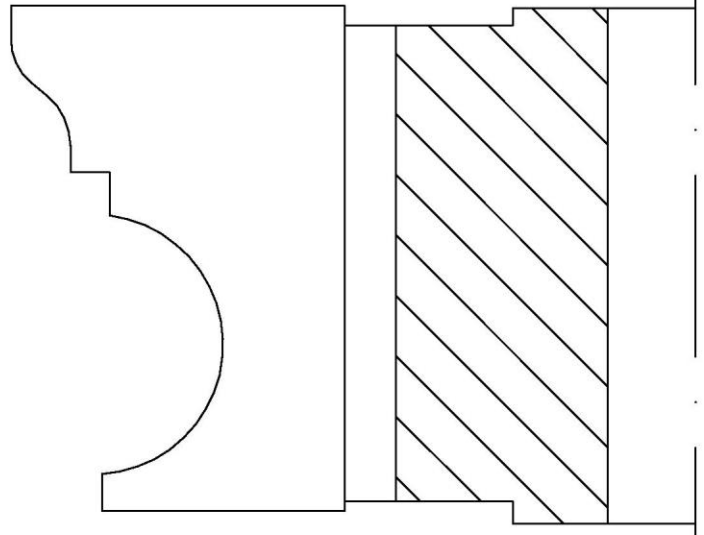
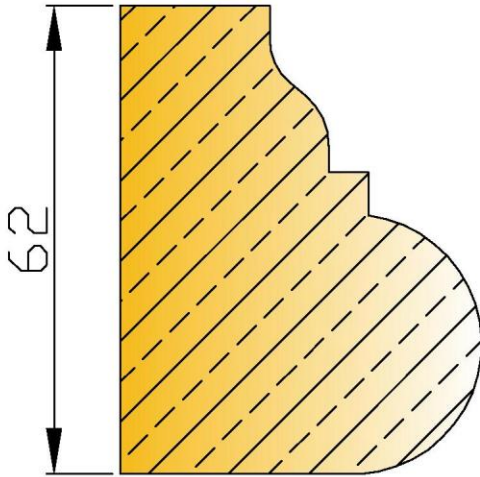

FK-174

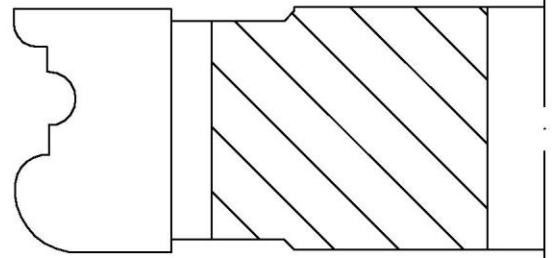
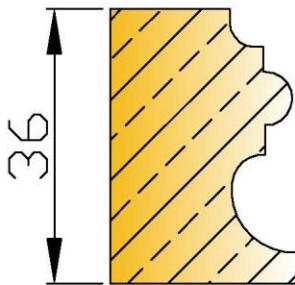

FK-175

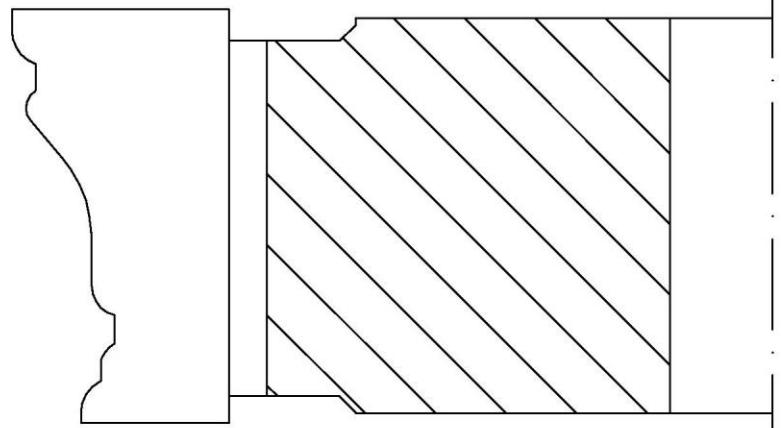
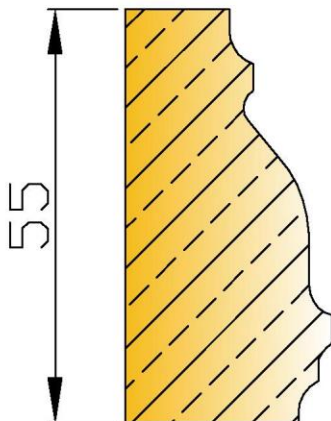

FK-176

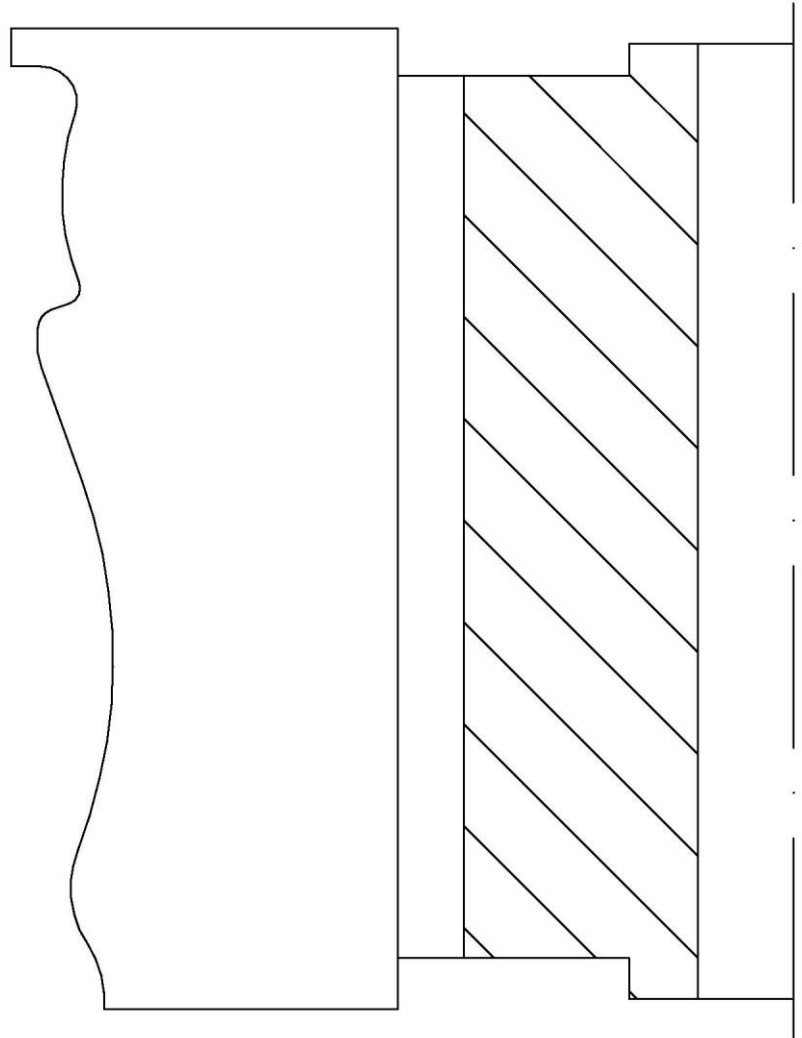
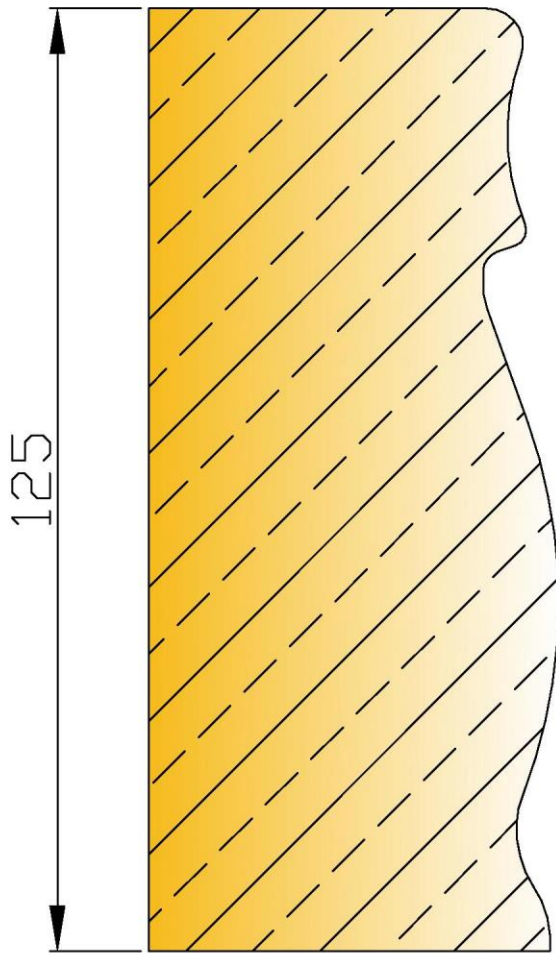

FK-177

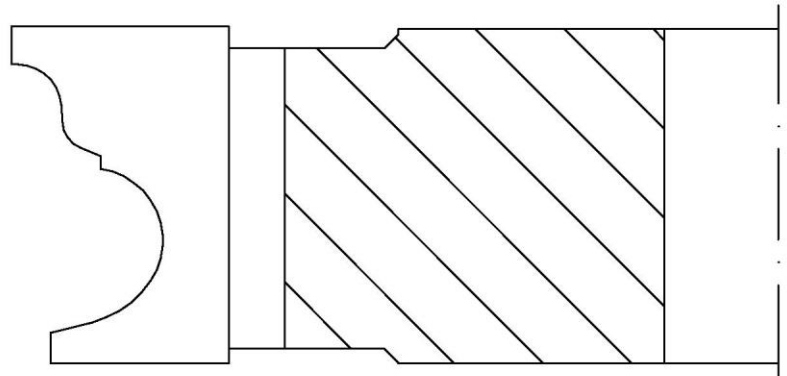
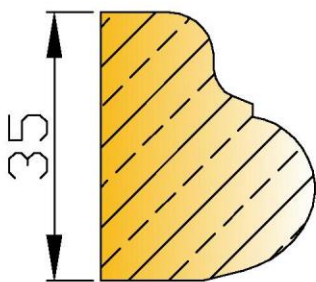

FK-178

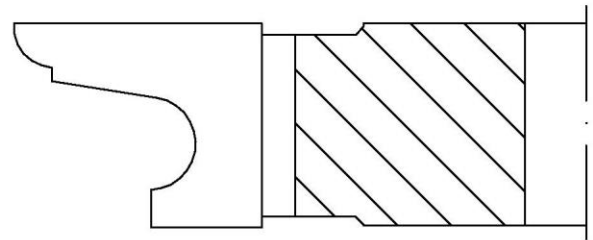
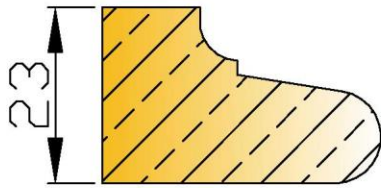

FK-179

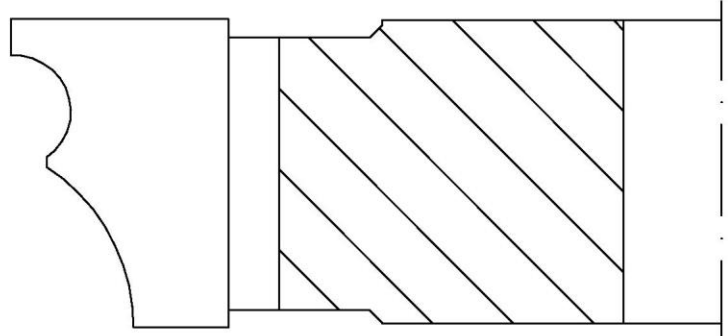
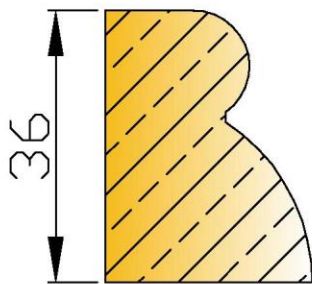

FK-180

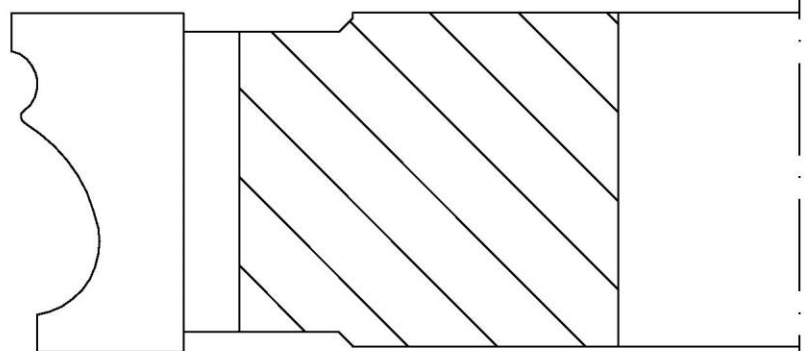
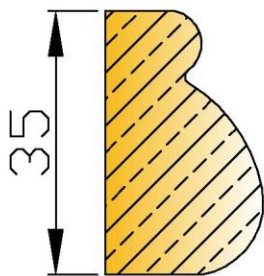

FK-181

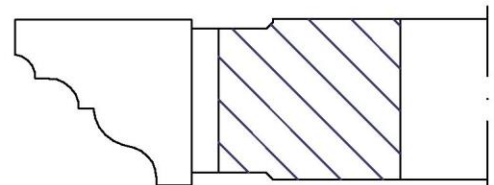

FK-182

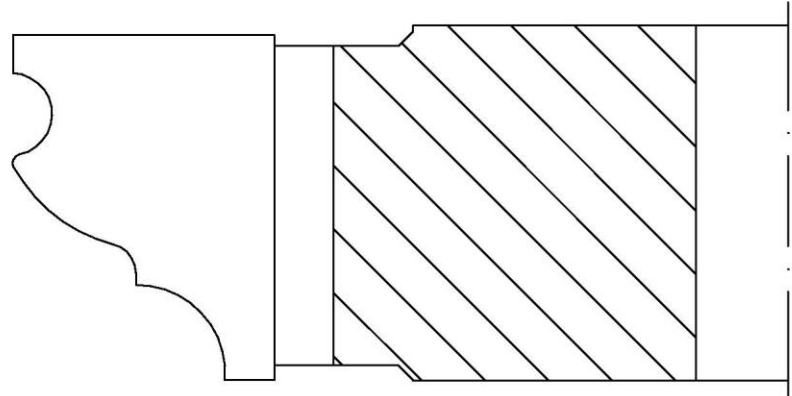
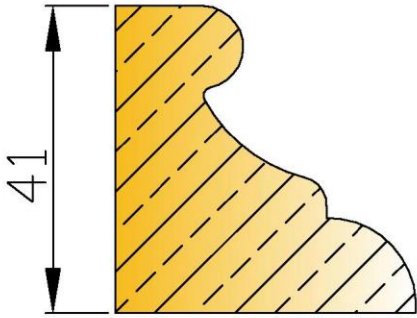

FK-183

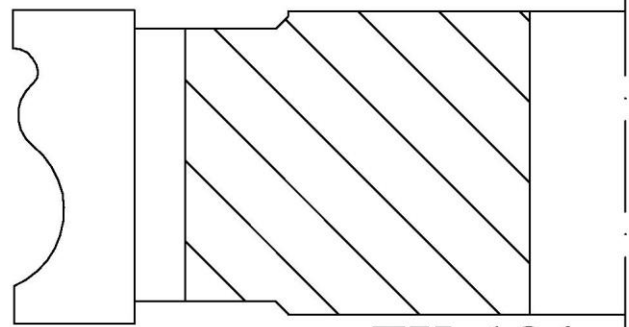
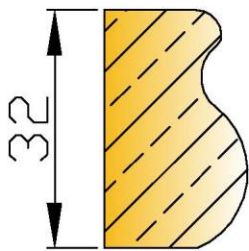

FK-184

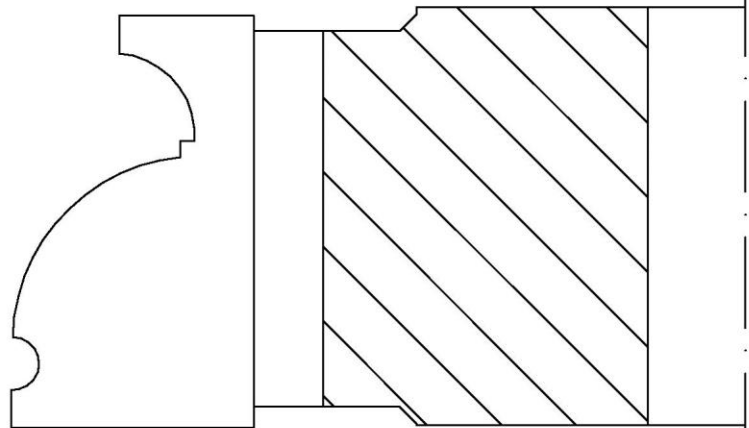
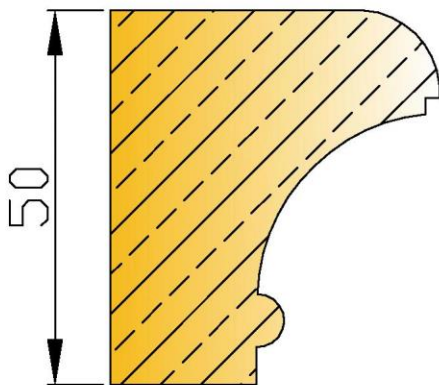

FK-185

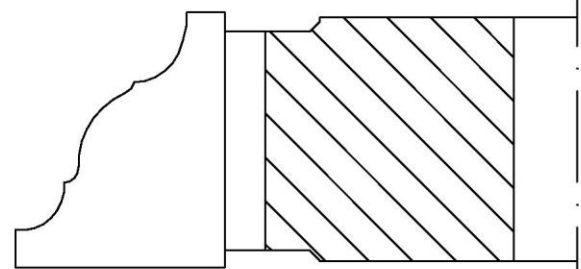
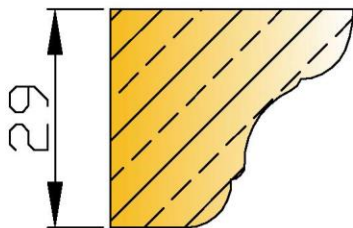

FK-186

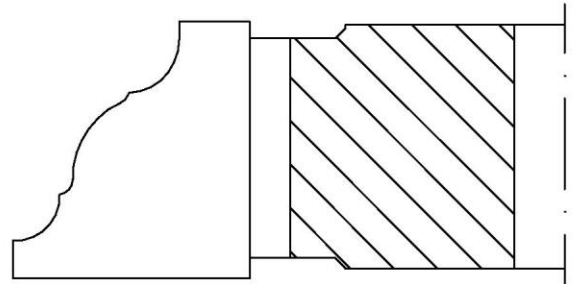
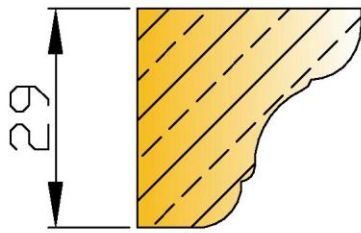
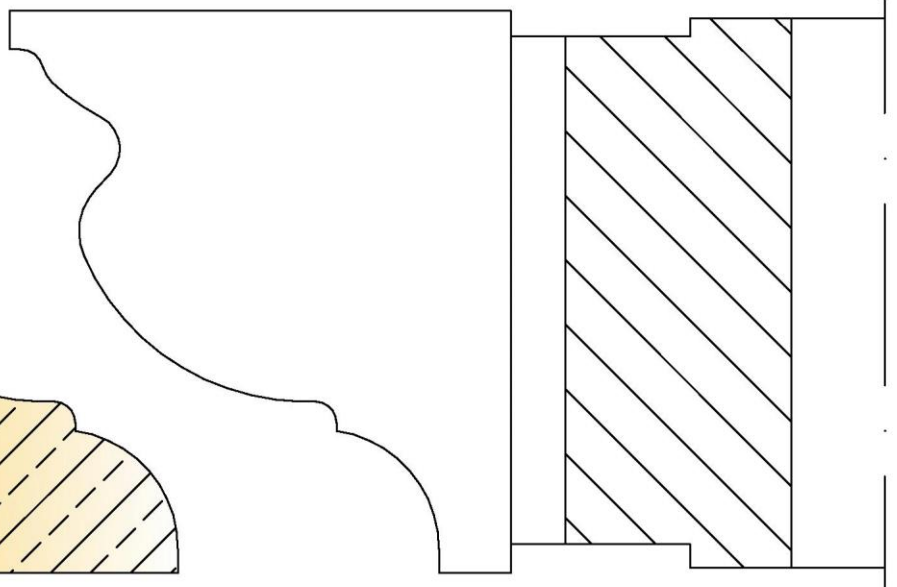
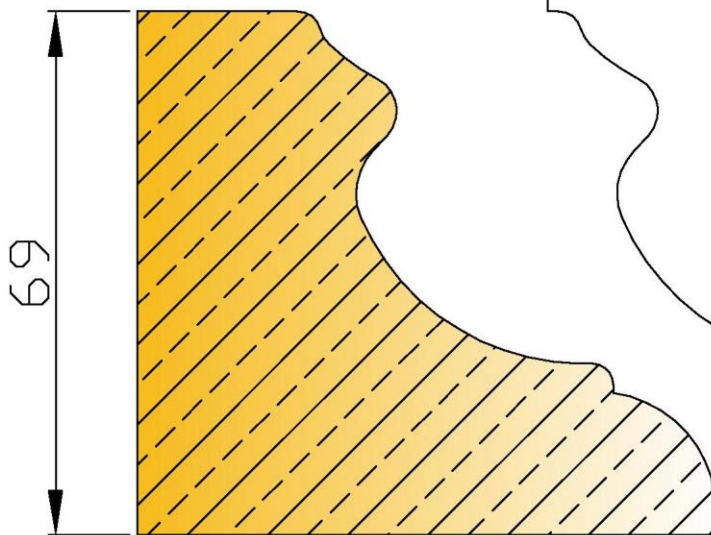
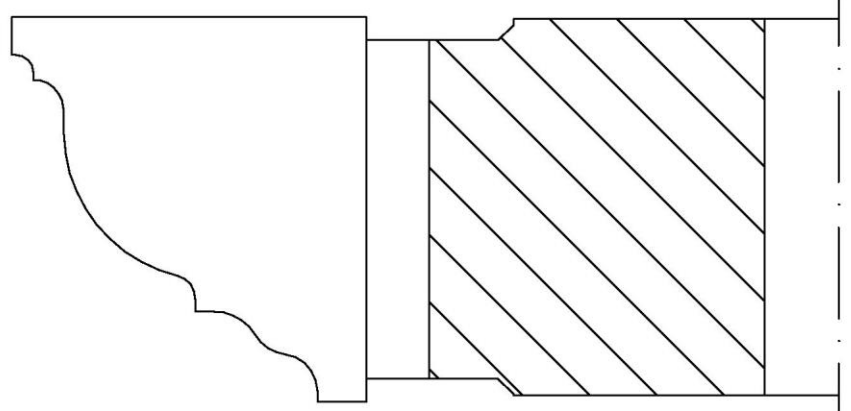
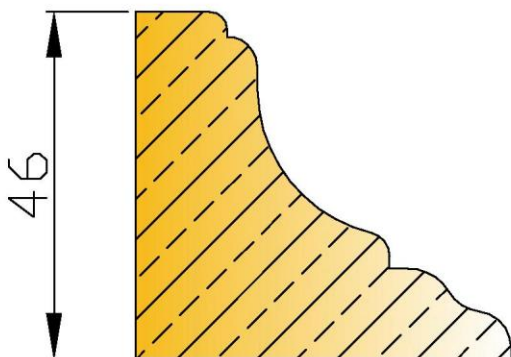
**FK-187****FK-188****FK-189**

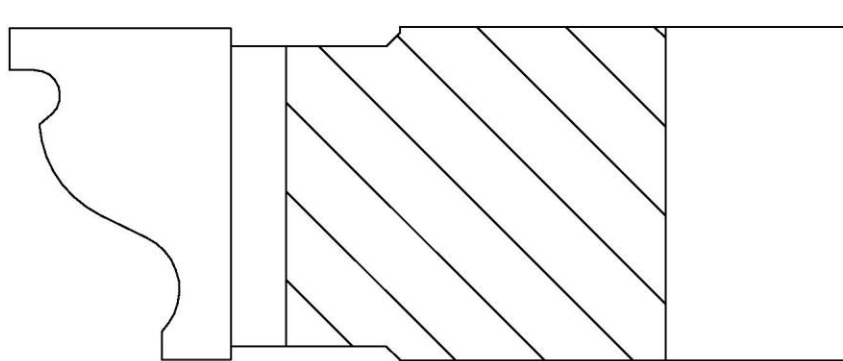
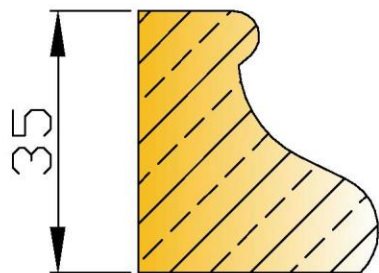

FK-190

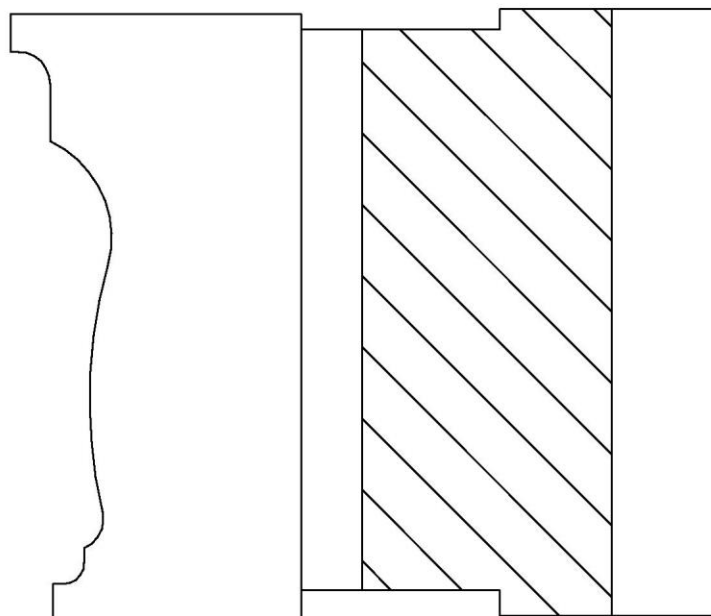
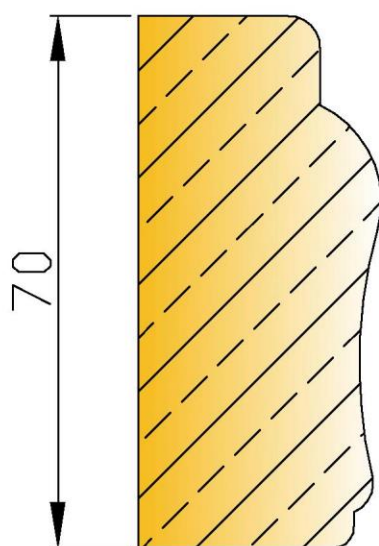

FK-191

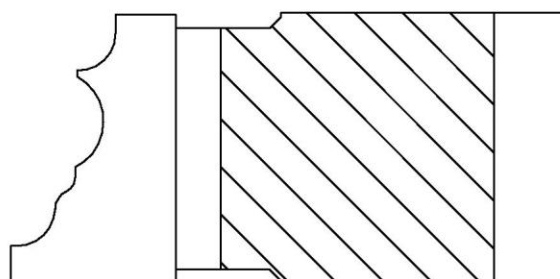
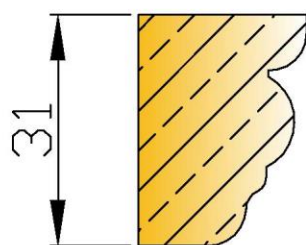

FK-192

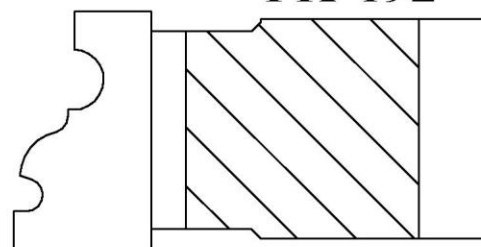
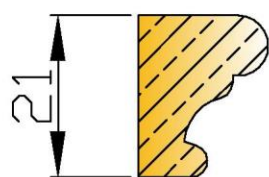

FK-193

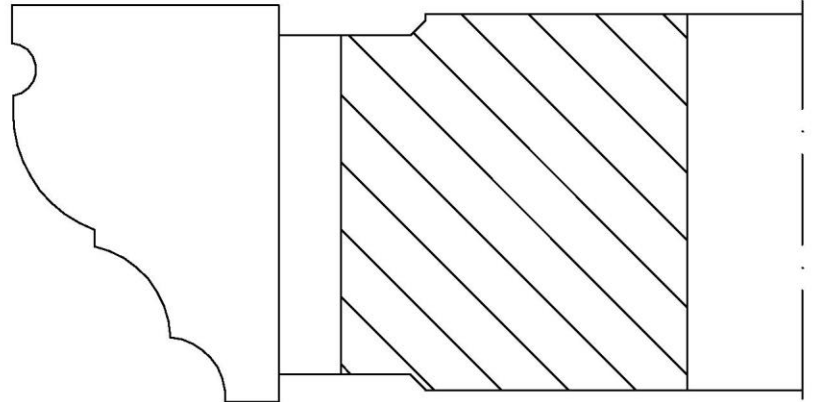
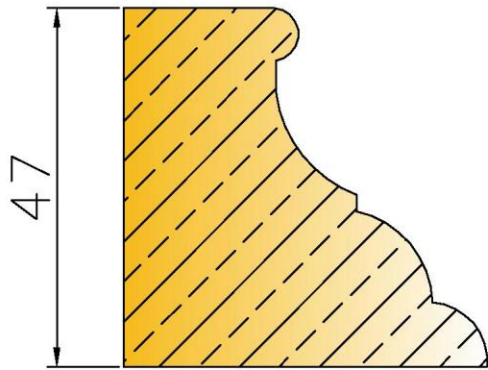

FK-194

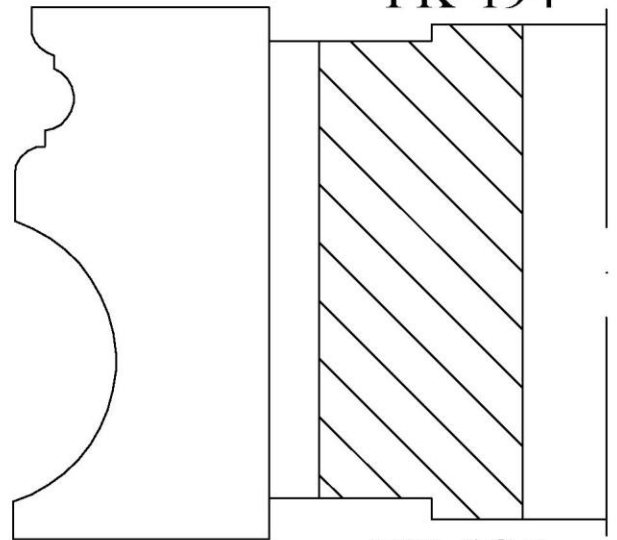
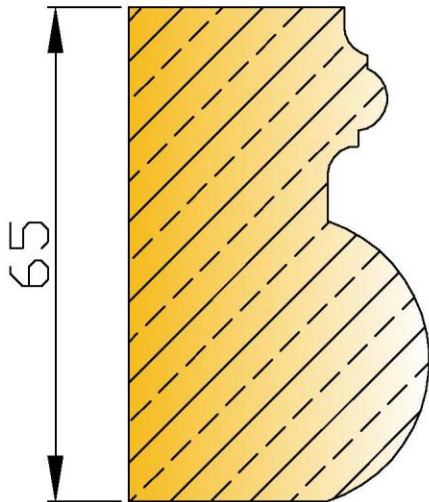

FK-195

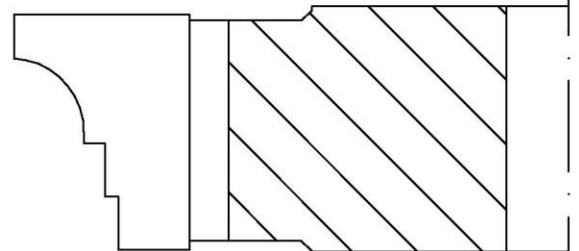
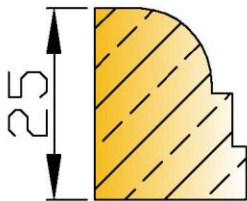

FK-196

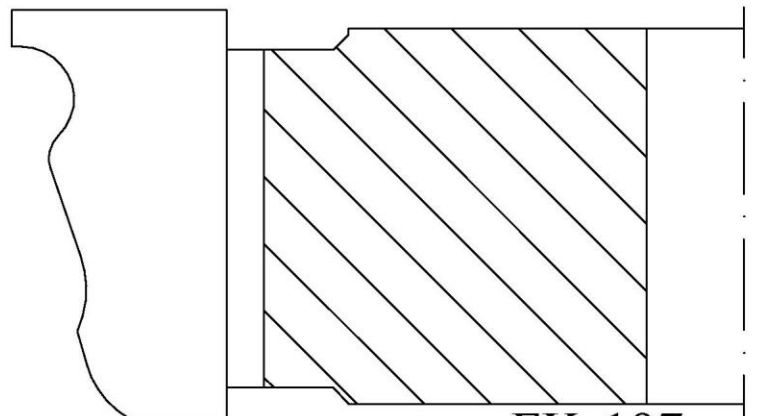
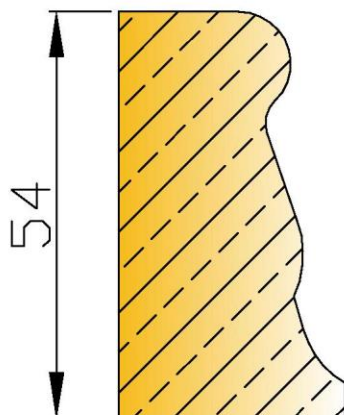

FK-197

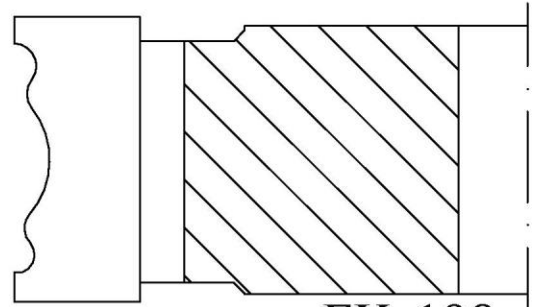
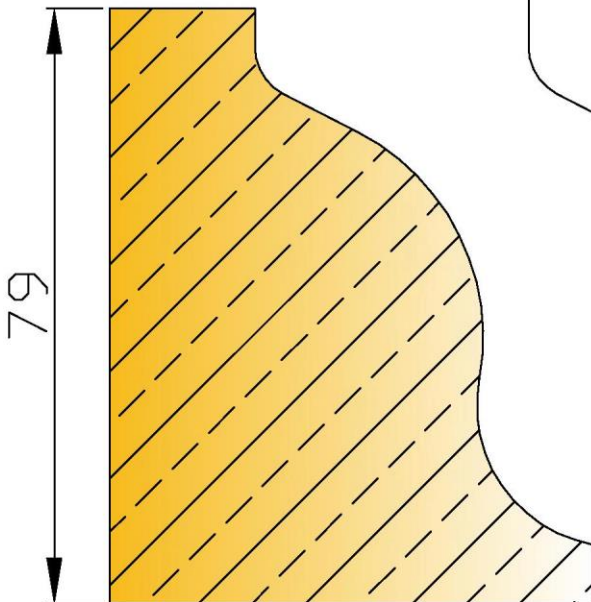
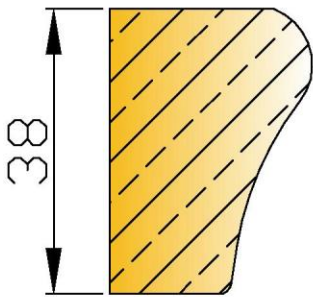
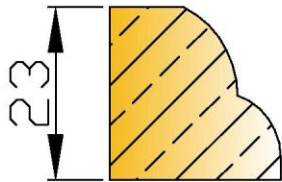
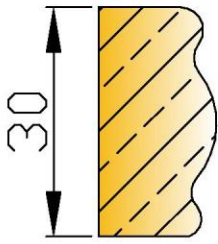

FK-198

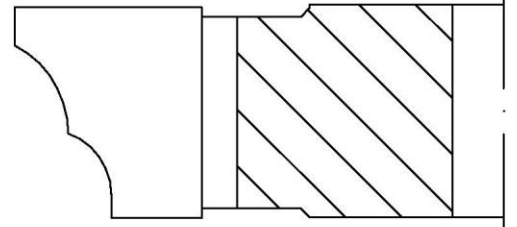

FK-199

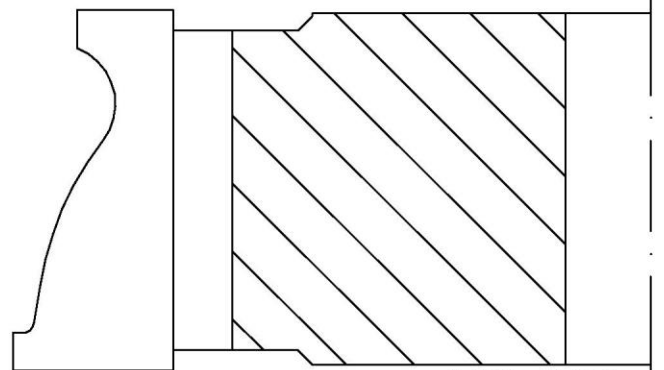

FK-200

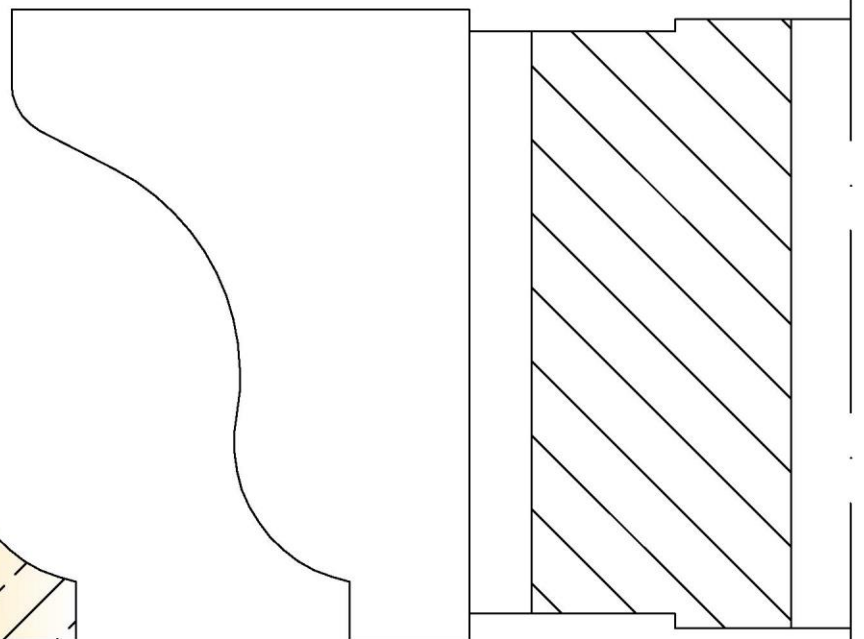

FK-201

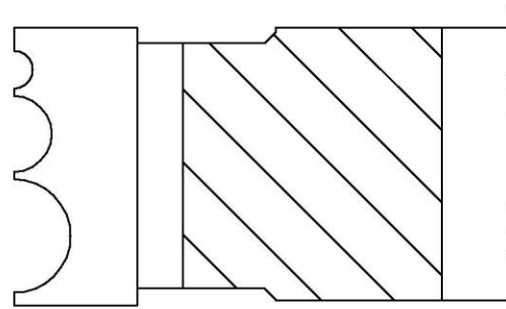
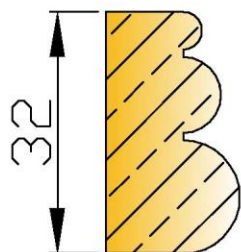

FK-202

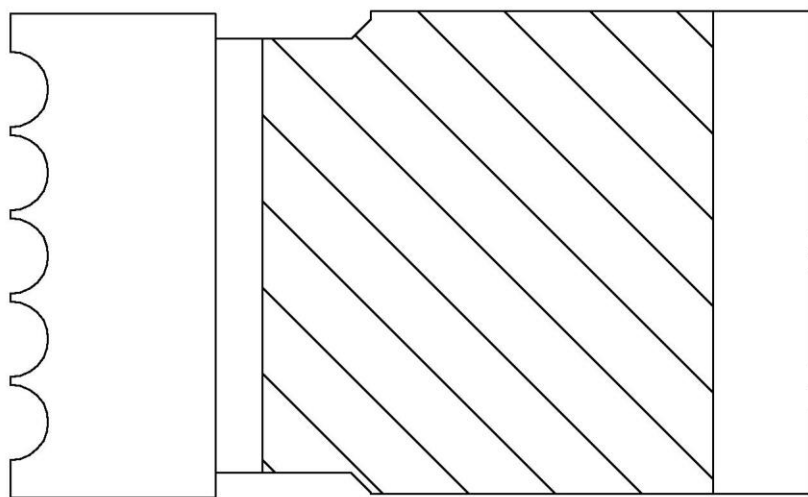
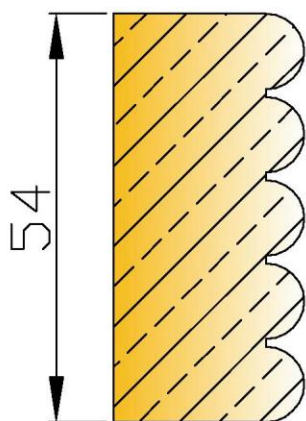

FK-203

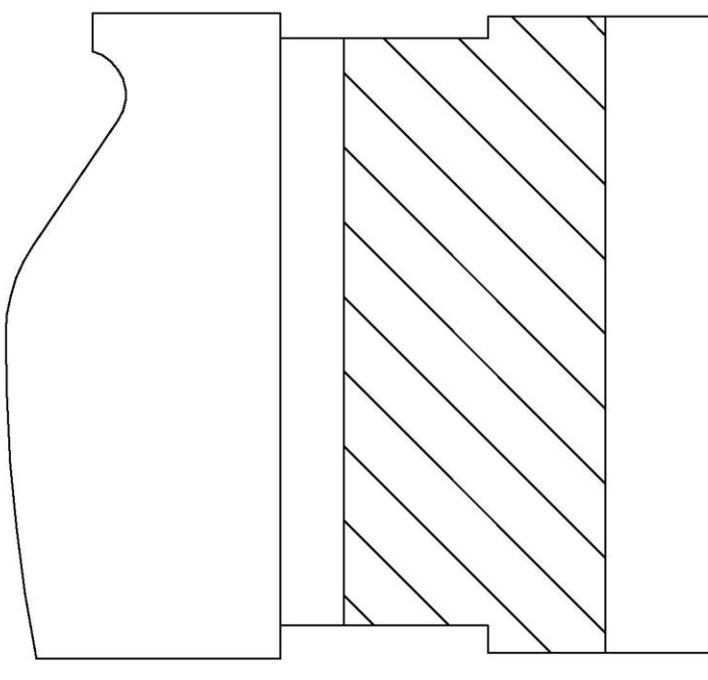
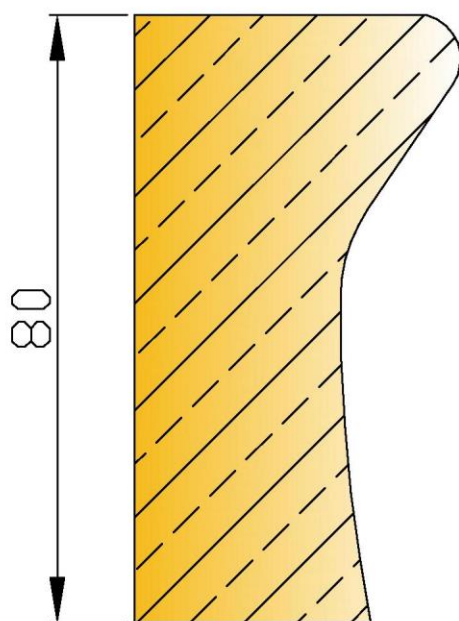

FK-204

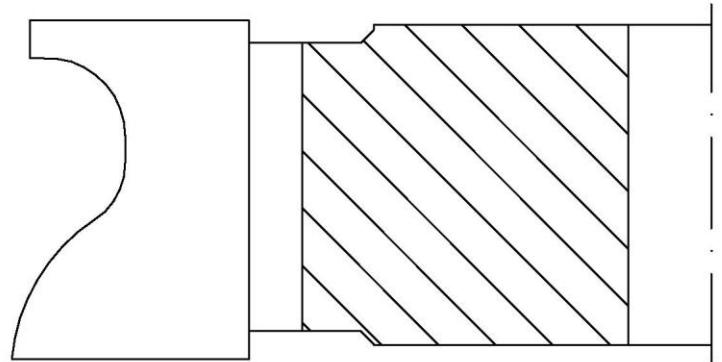
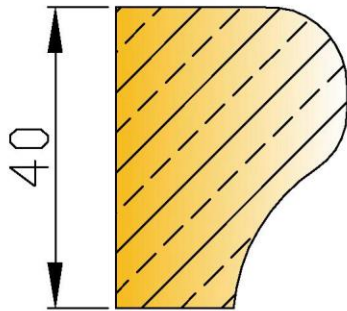

FK-205

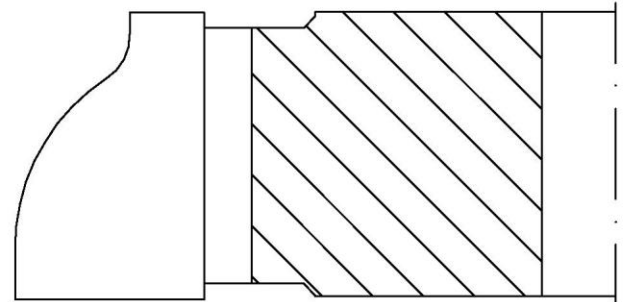
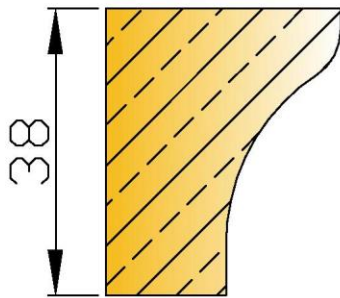

FK-206

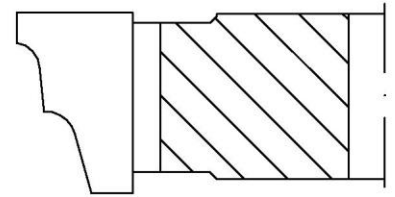
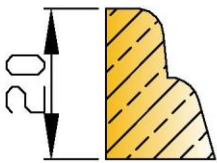

FK-207

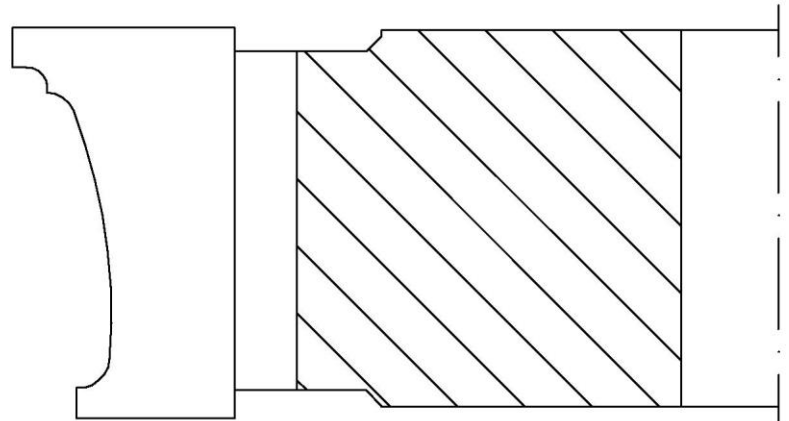
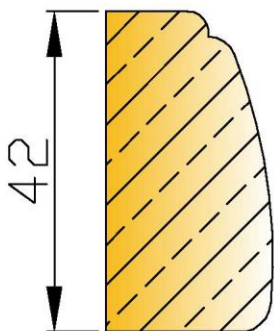

FK-208

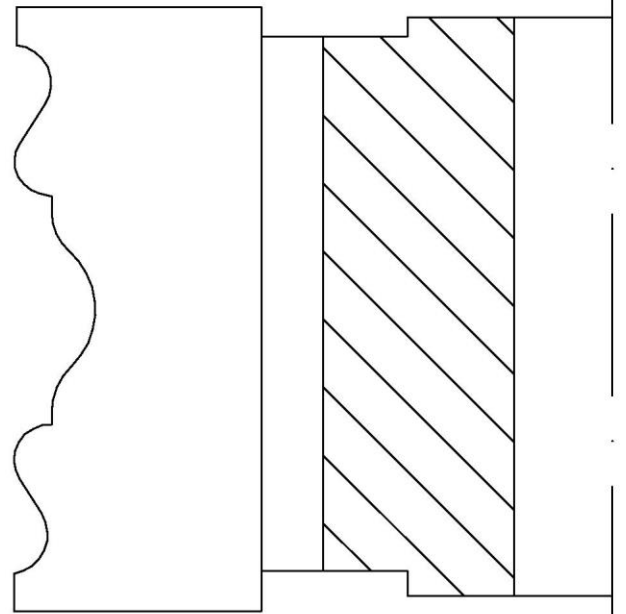
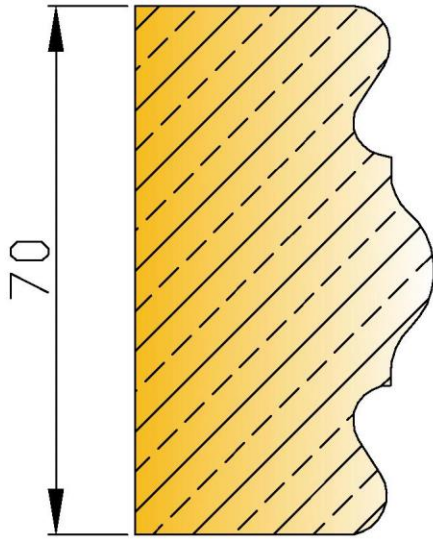

FK-209

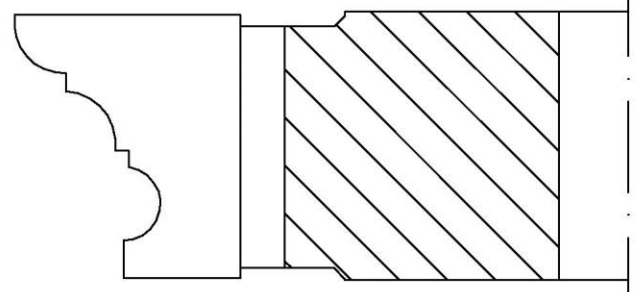
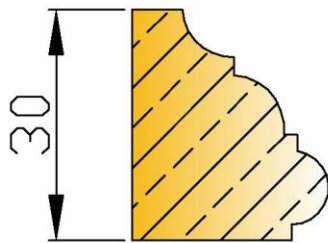

FK-210

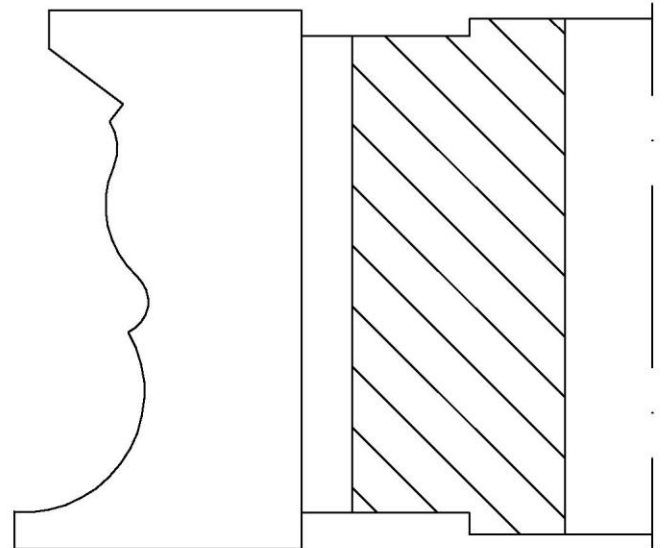
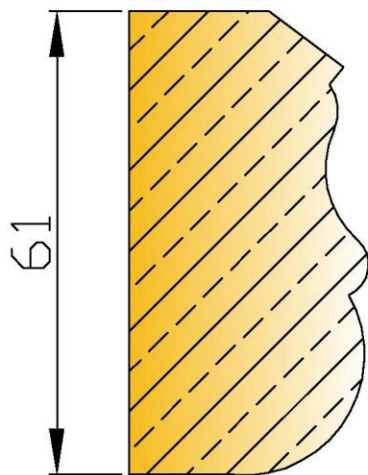

FK-211

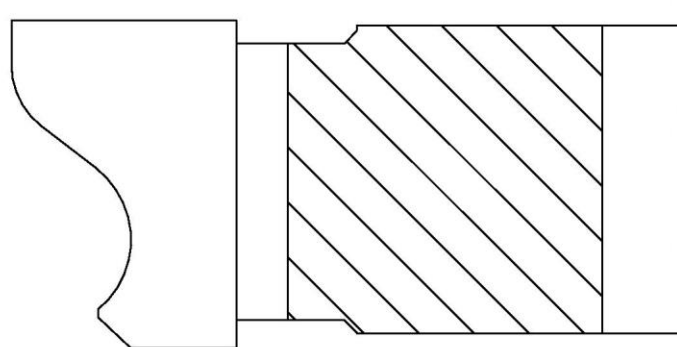
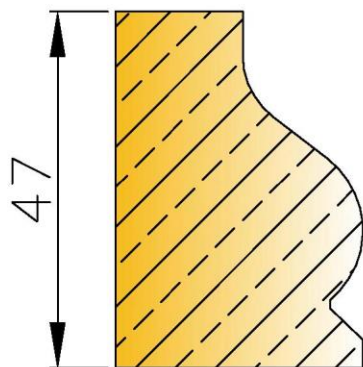
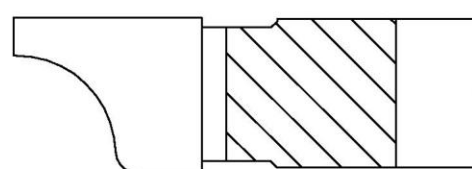
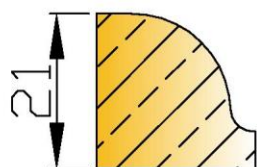
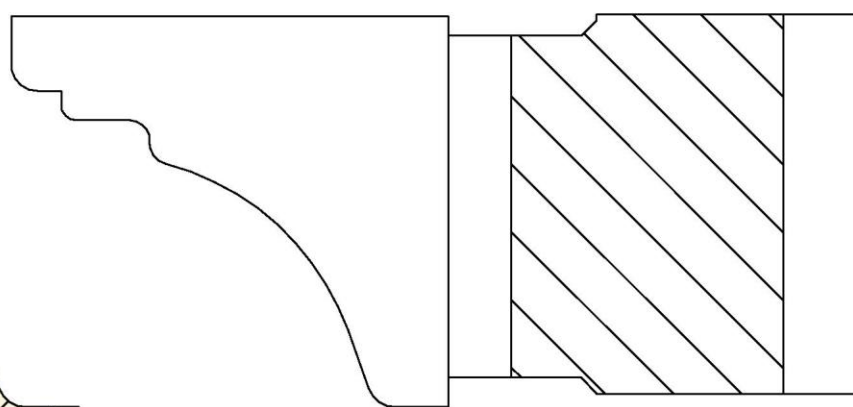
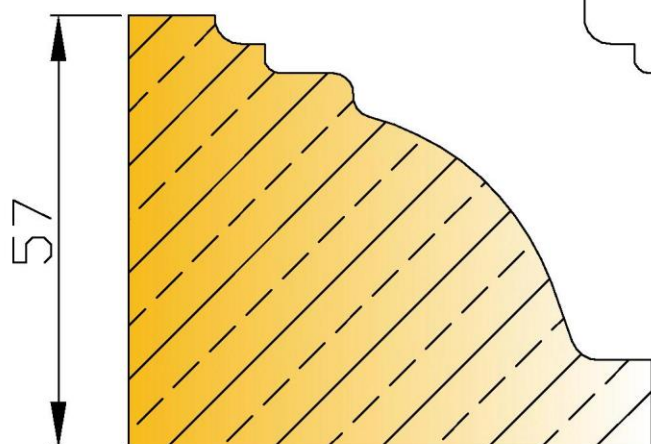
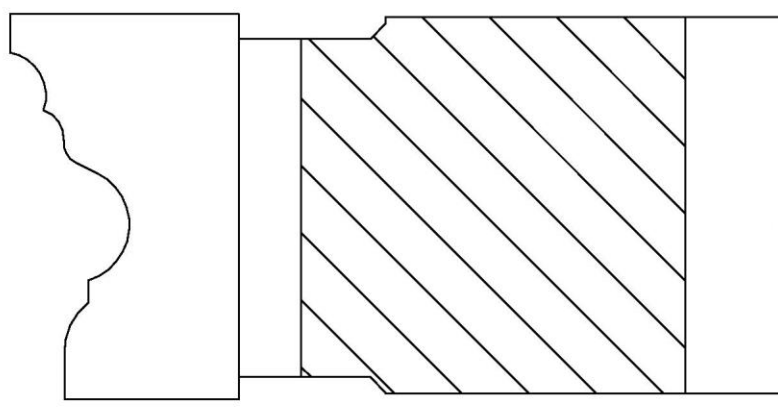
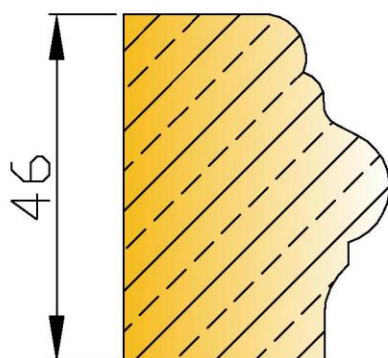
**FK-212****FK-213****FK-214****FK-215**

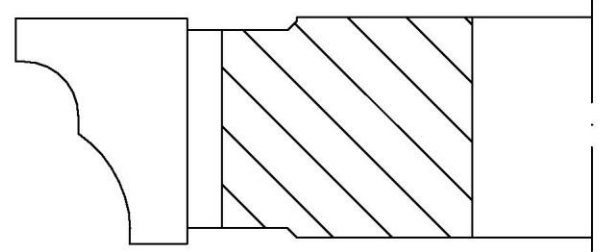
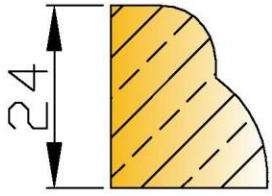

FK-216

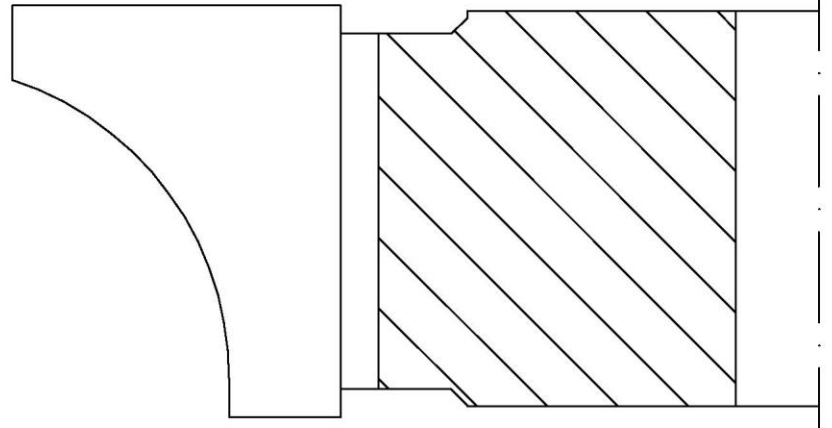
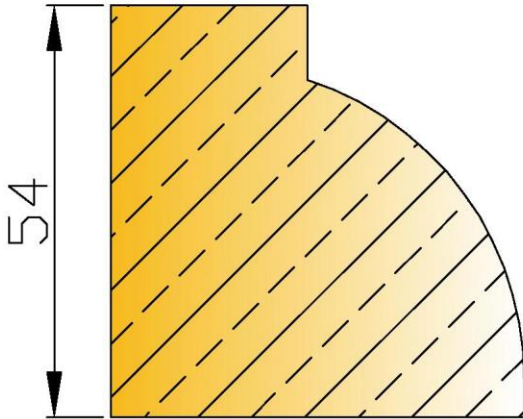

FK-217

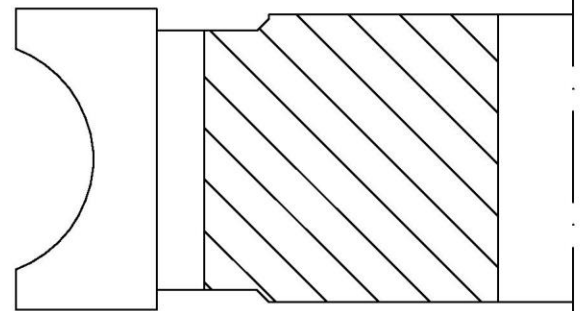
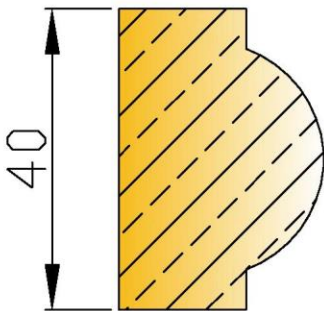

FK-218

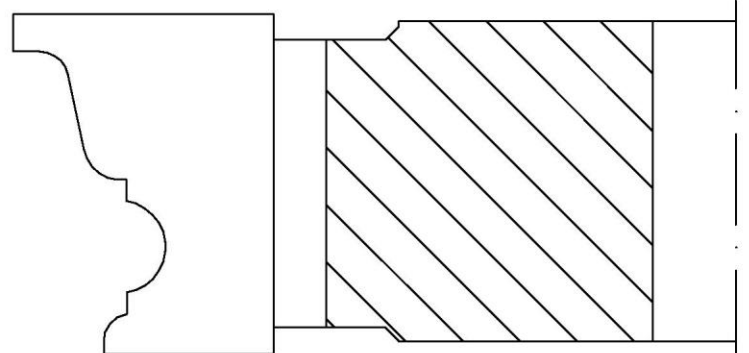
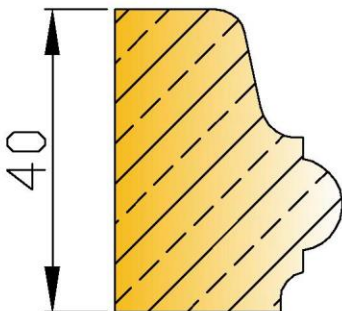

FK-219

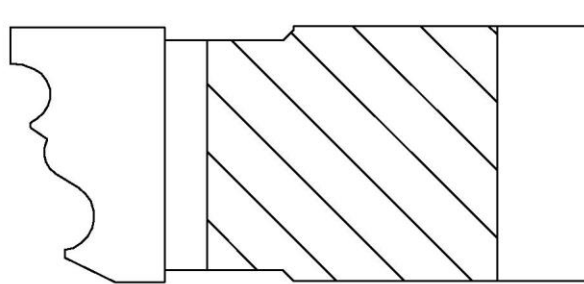
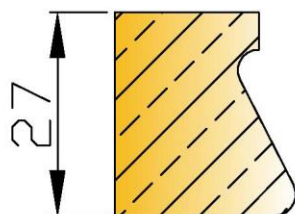
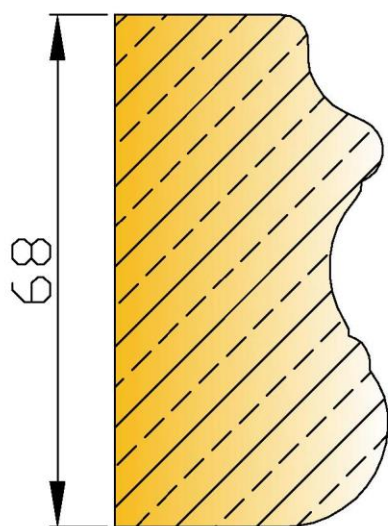
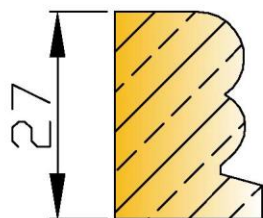
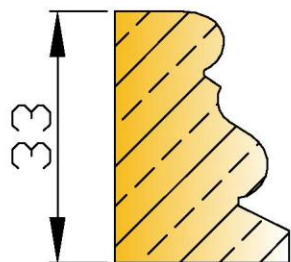

FK-220

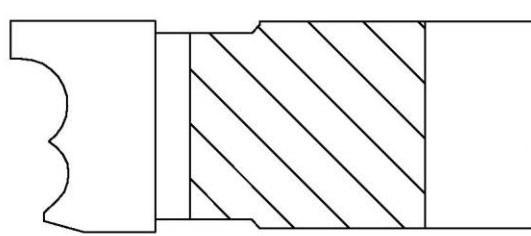

FK-221

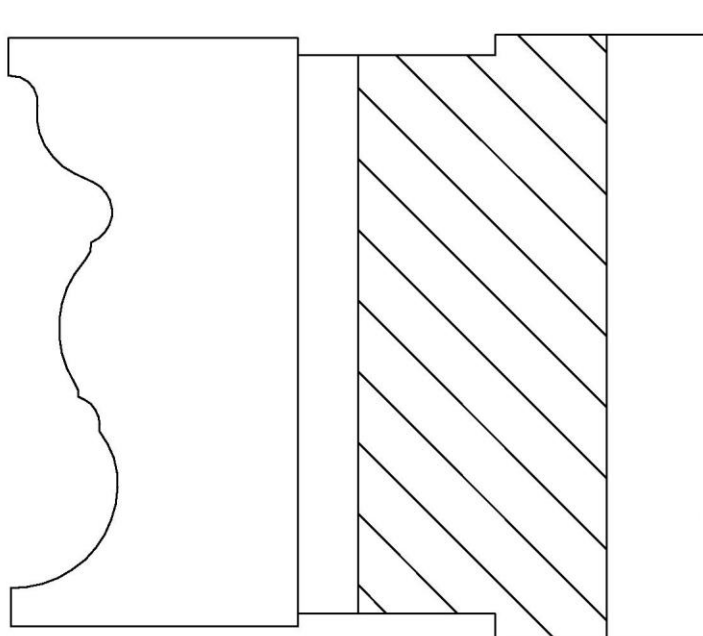

FK-222

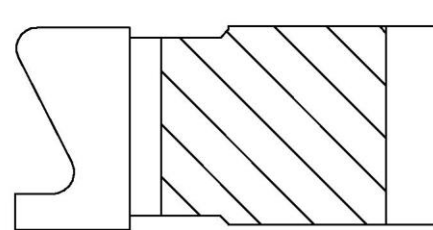

FK-223

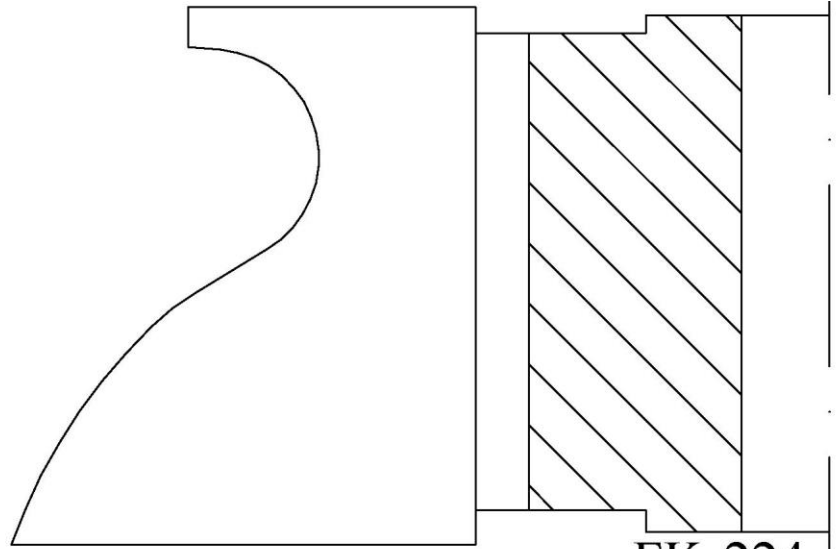
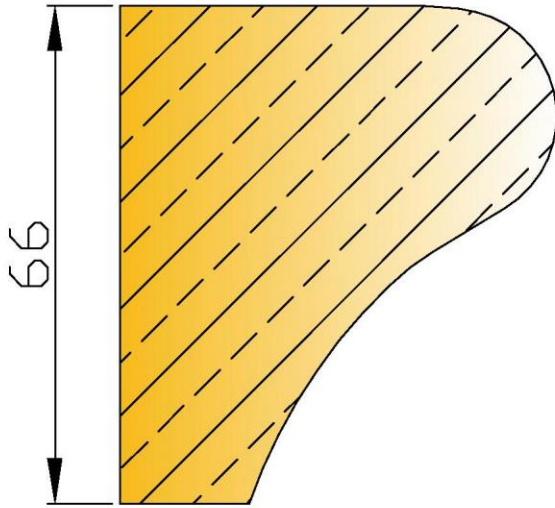

FK-224

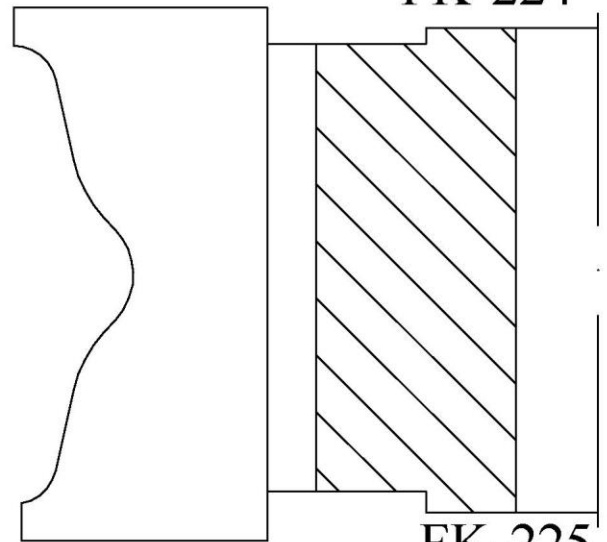
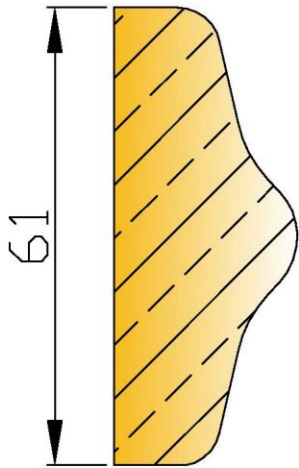

FK-225

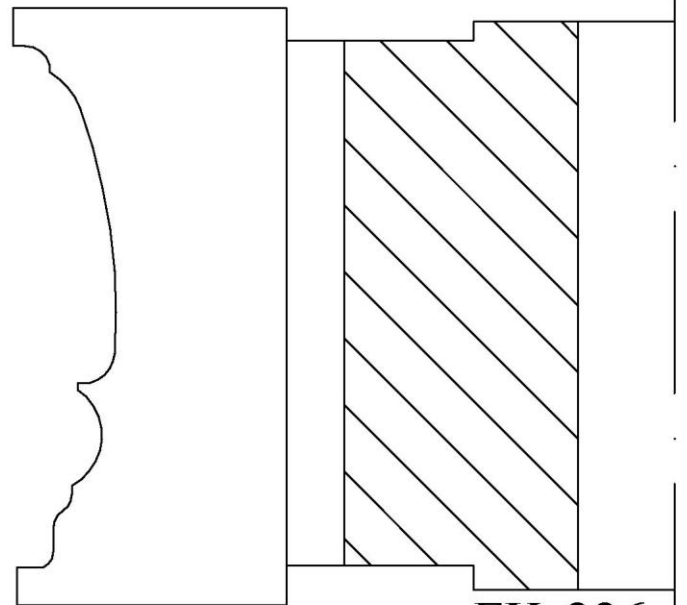
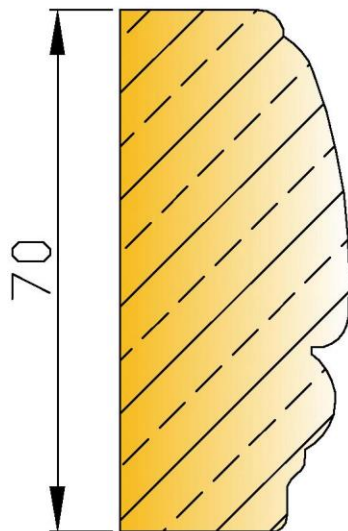

FK-226

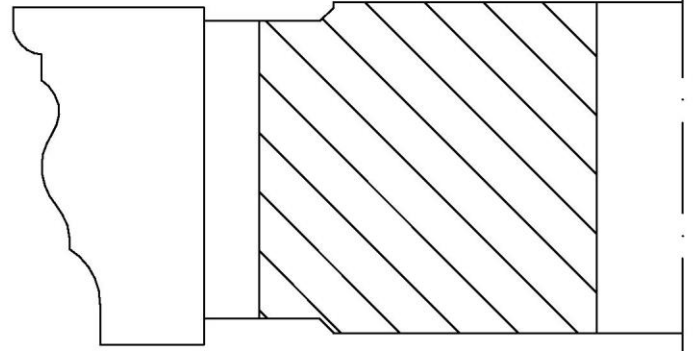
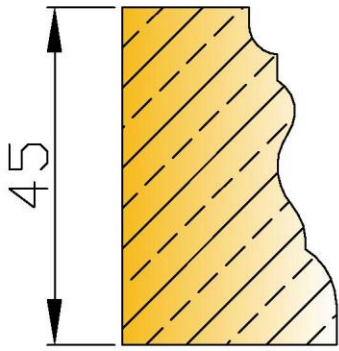

FK-227

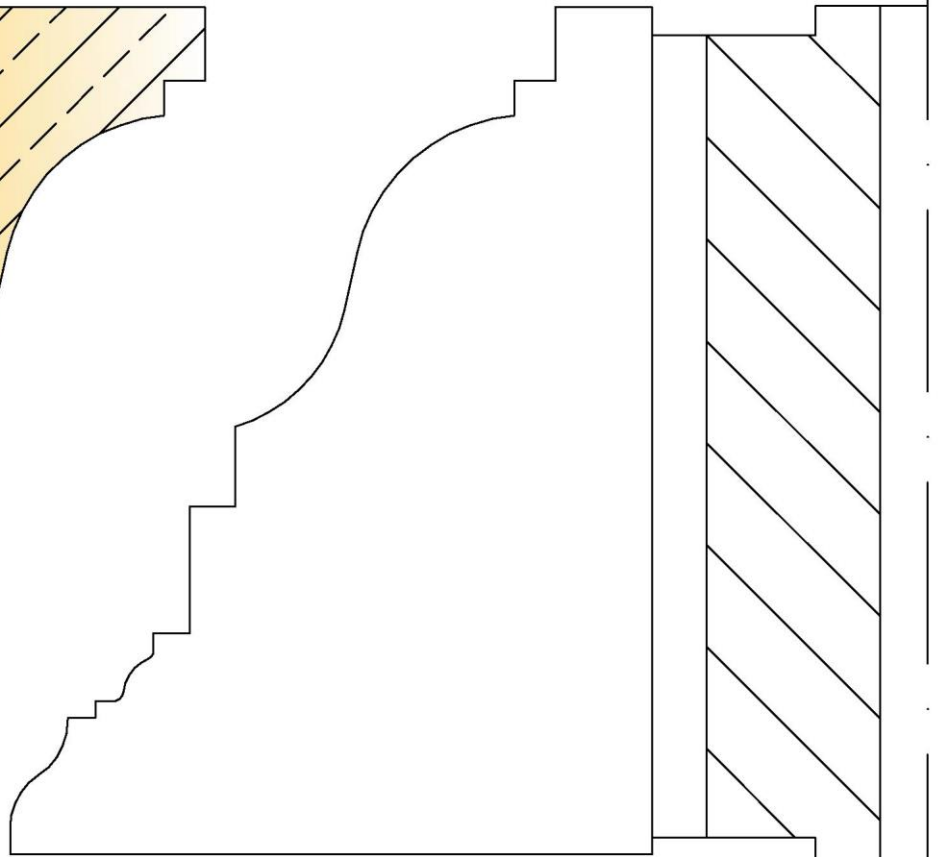
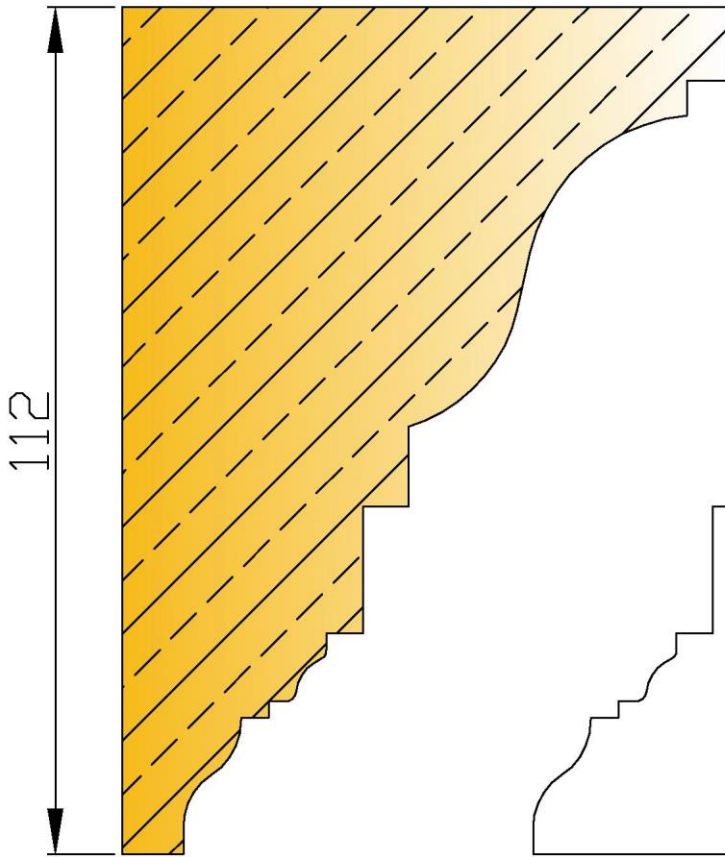

FK-228

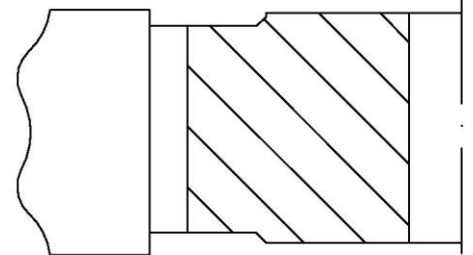
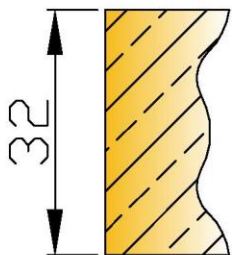

FK-229

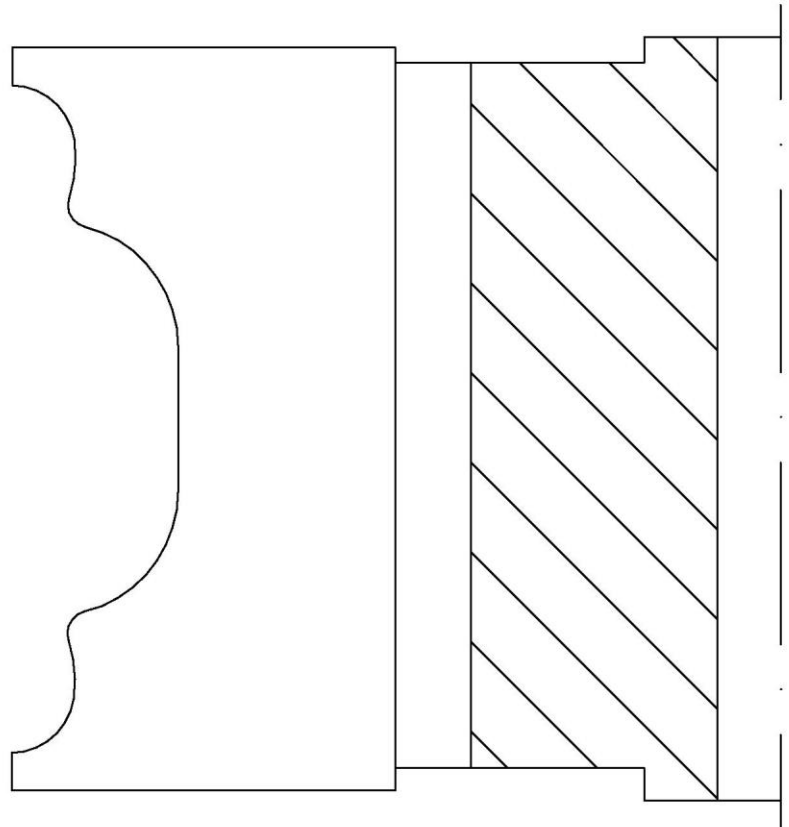
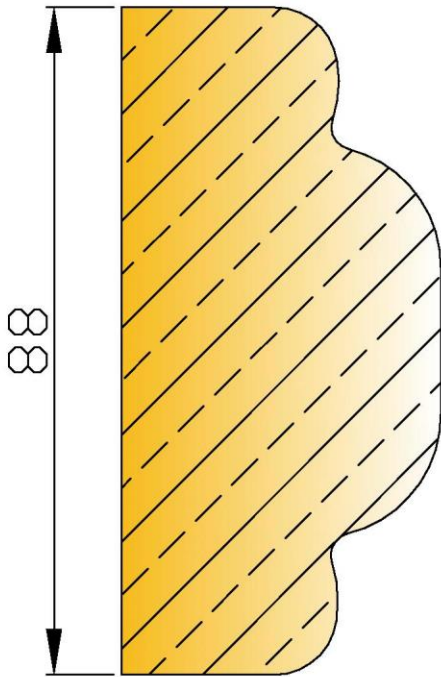

FK-230

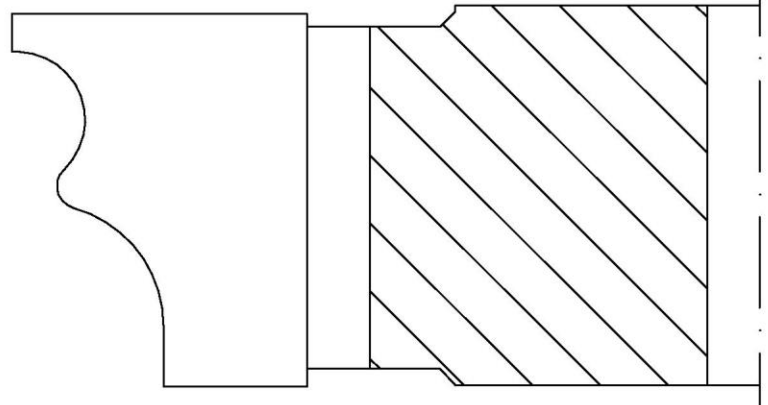
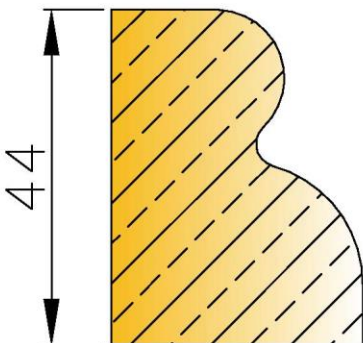

FK-231

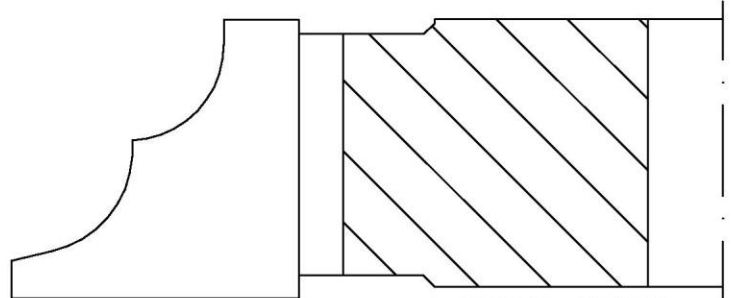
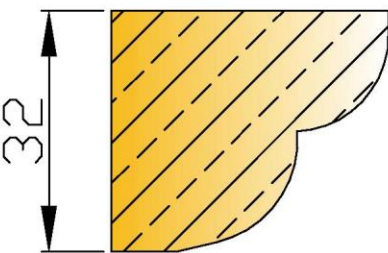

FK-232

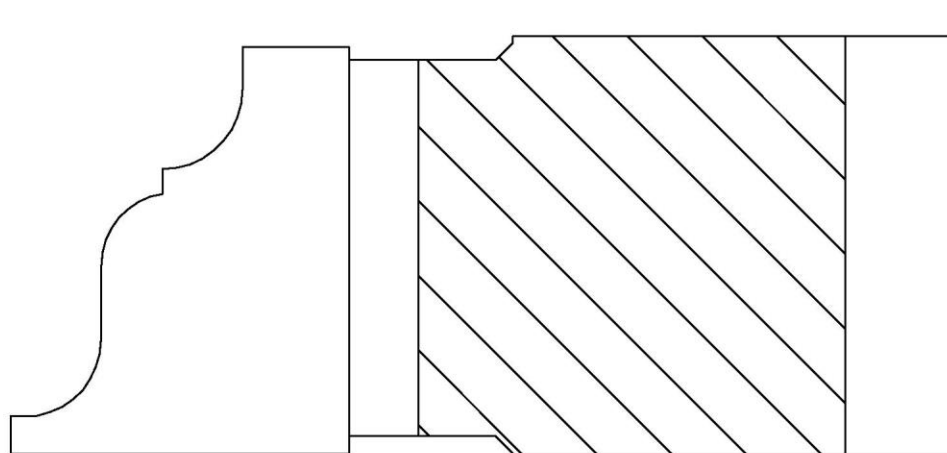
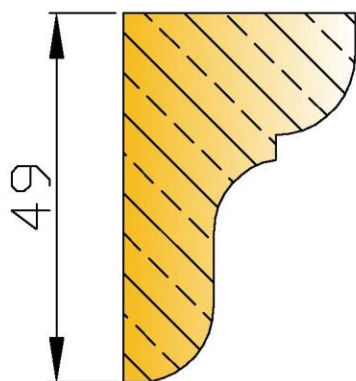

FK-233

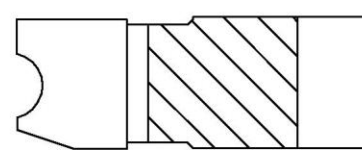
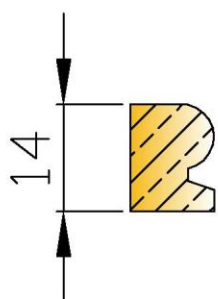

FK-234

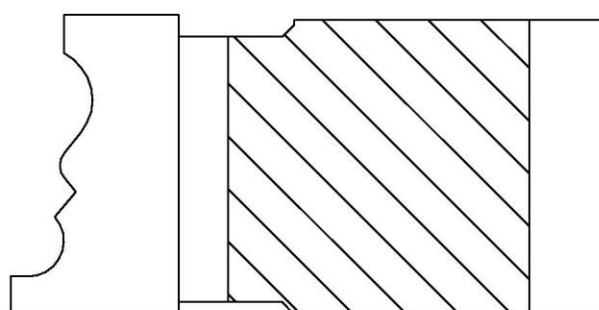
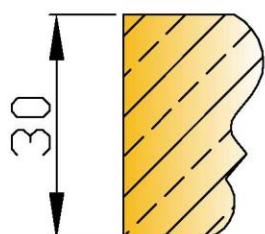

FK-235

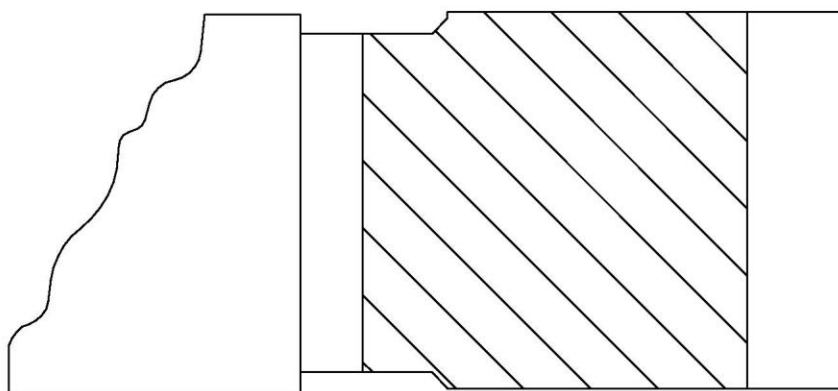
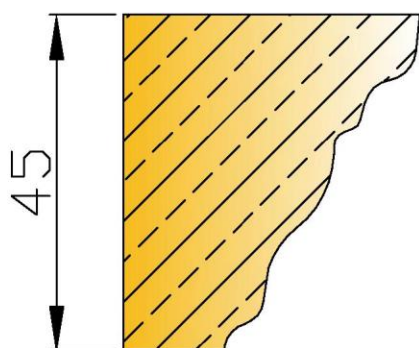

FK-236

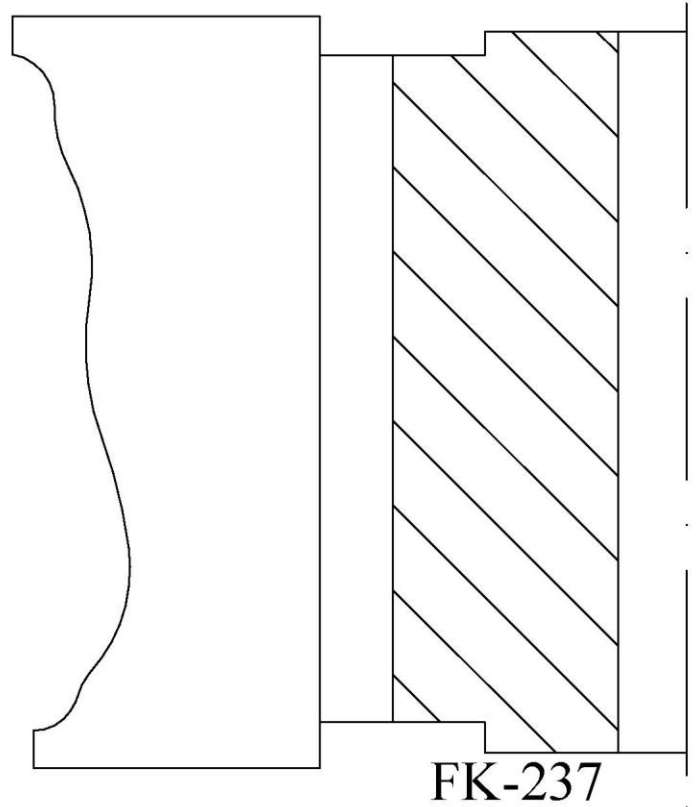
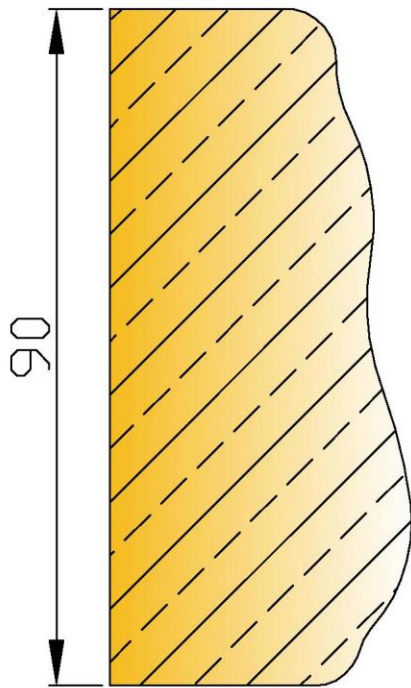

FK-237

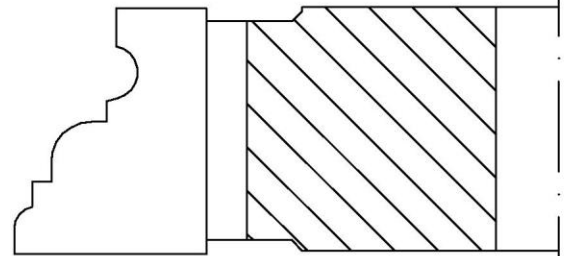
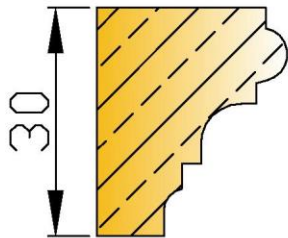

FK-238

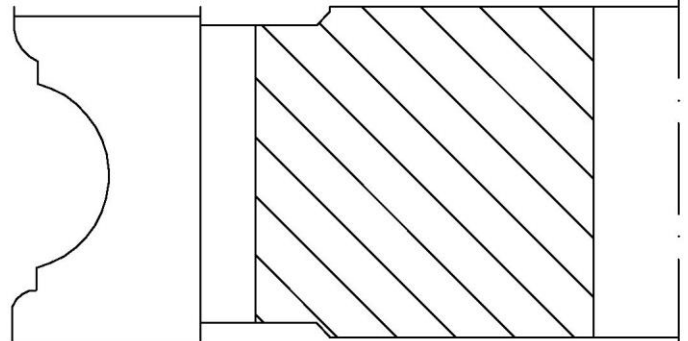
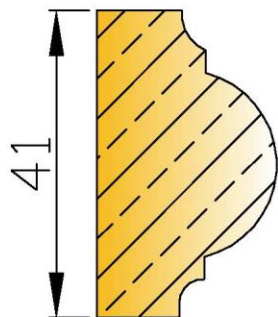

FK-239

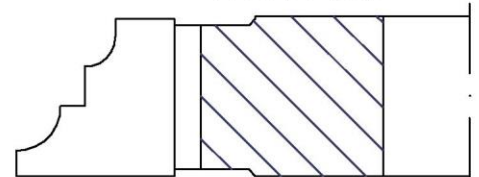
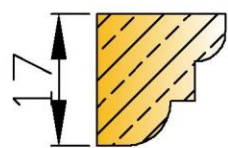

FK-240

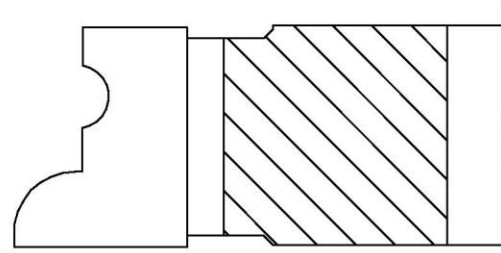
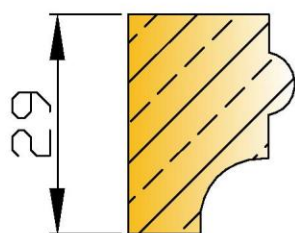

FK-241

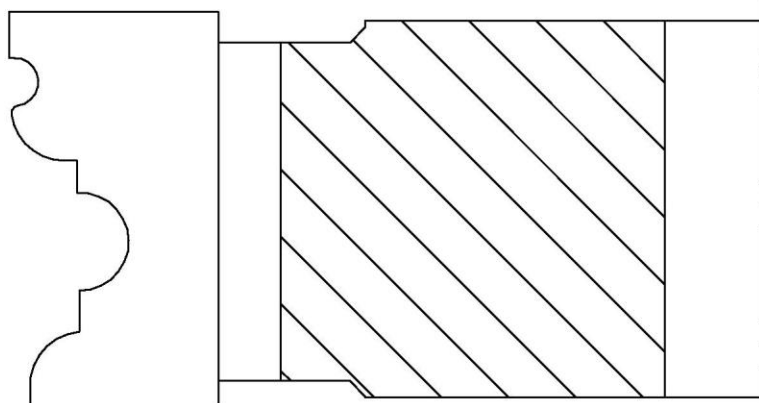
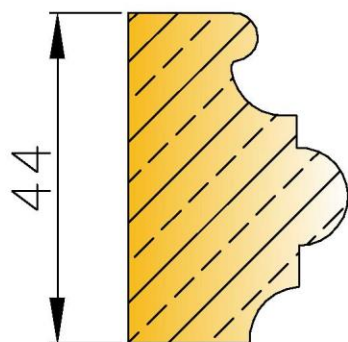

FK-242

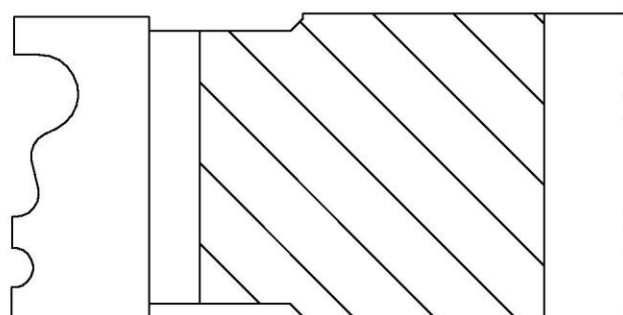
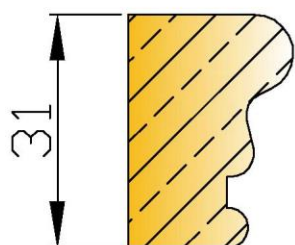

FK-243

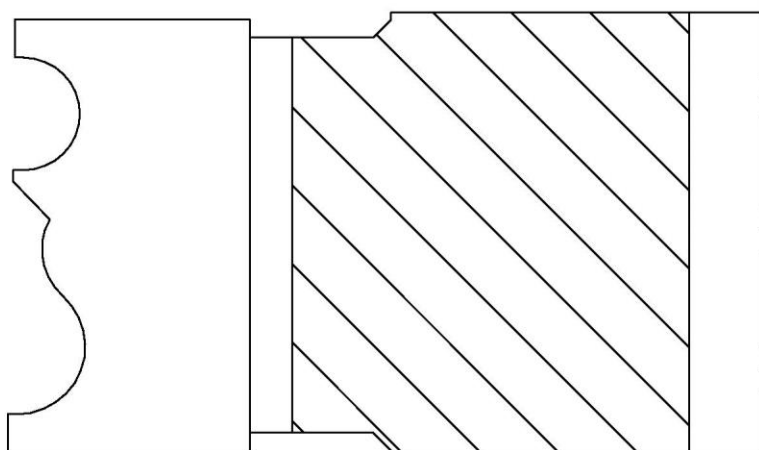
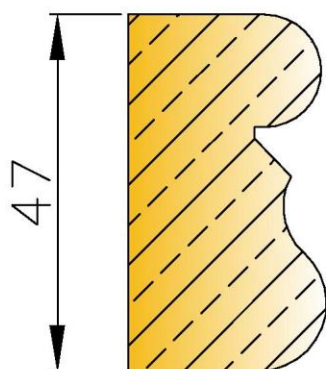

FK-244

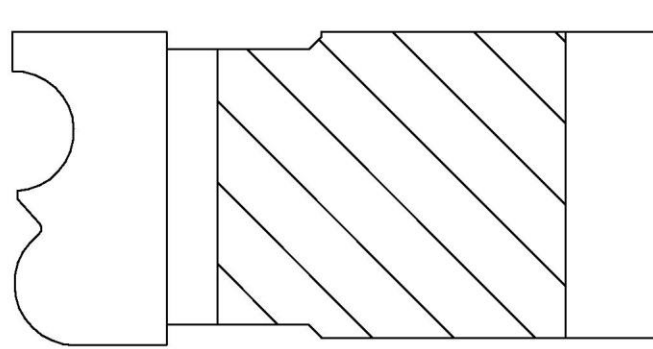
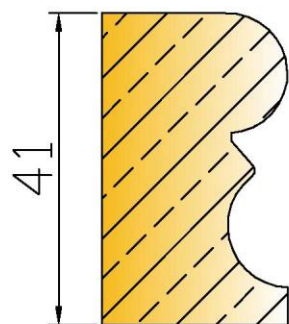

FK-245

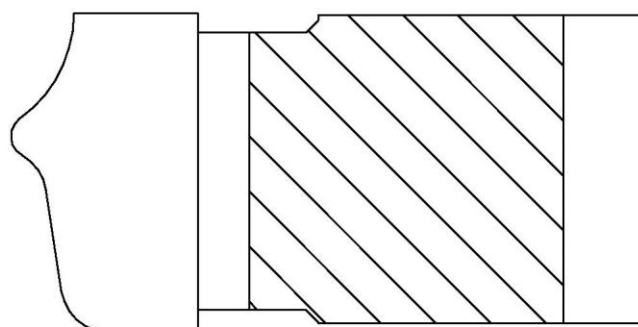
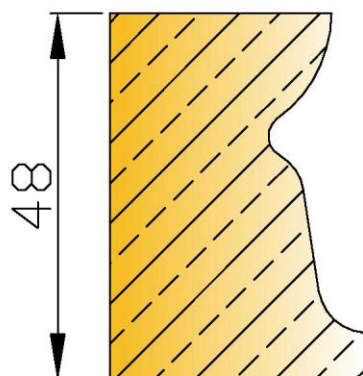

FK-246

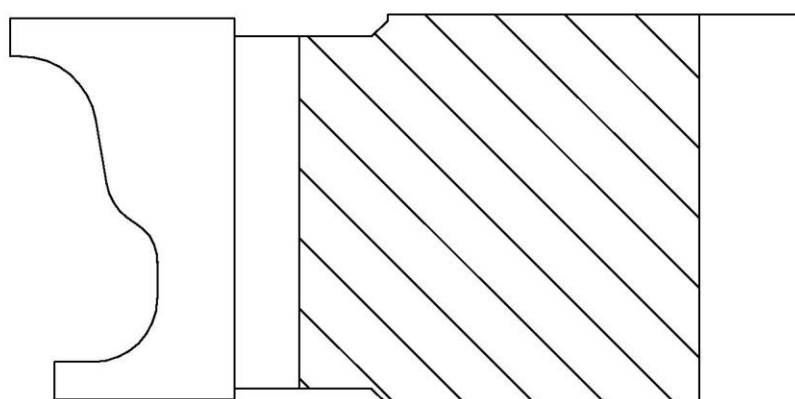
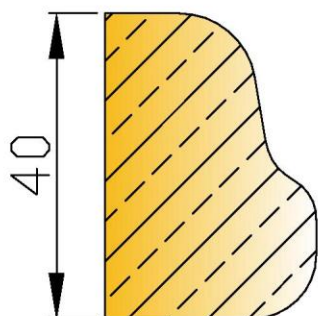

FK-247

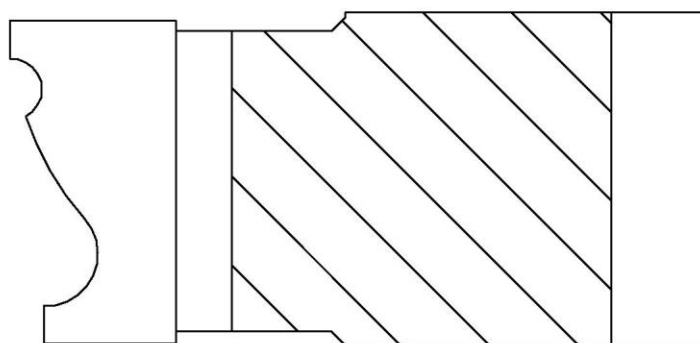
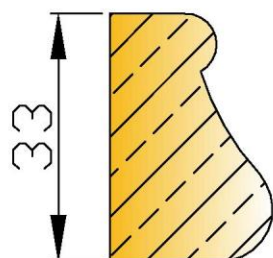

FK-248

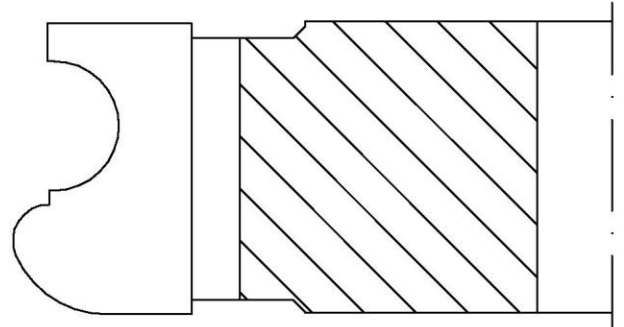
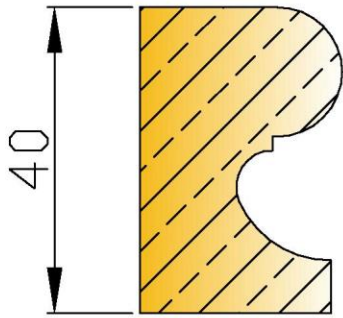

FK-249

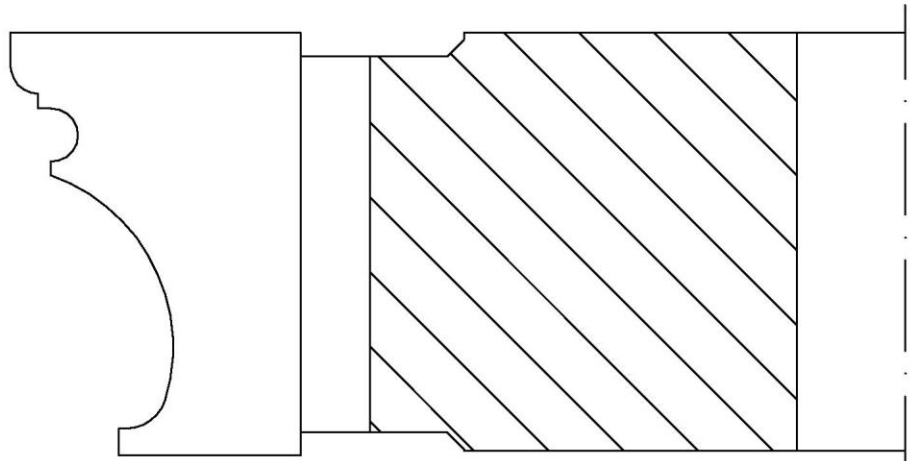
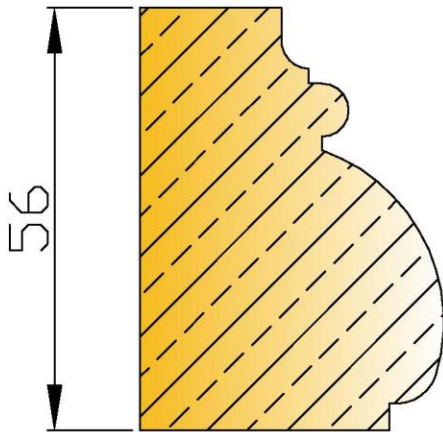

FK-250

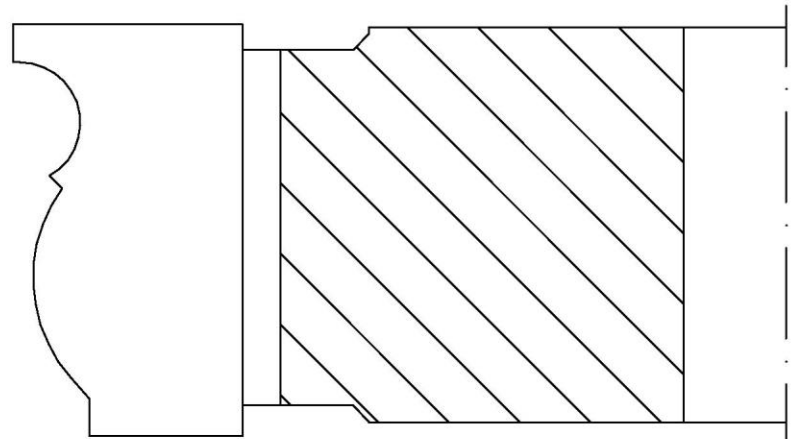
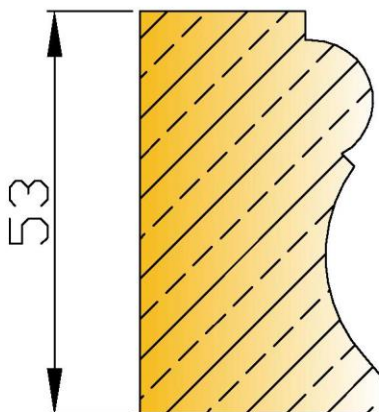

FK-251

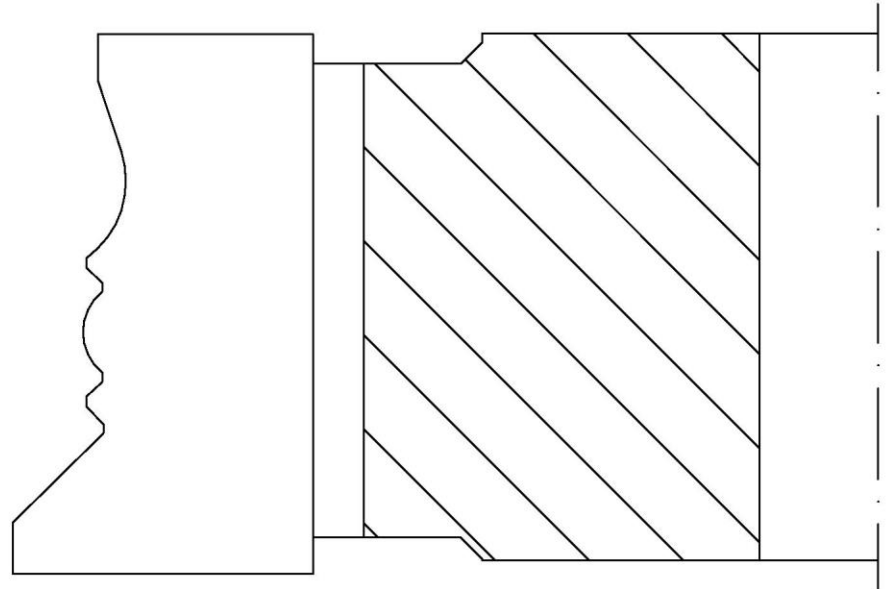
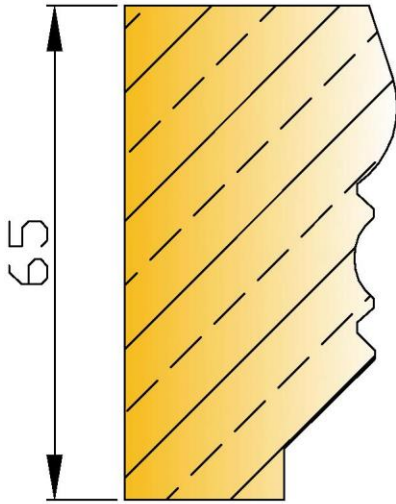

FK-252

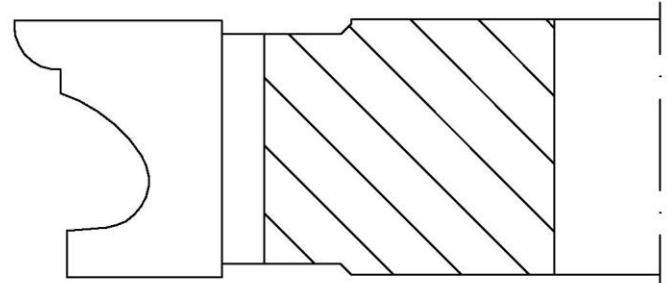
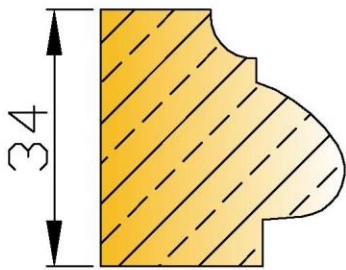

FK-253

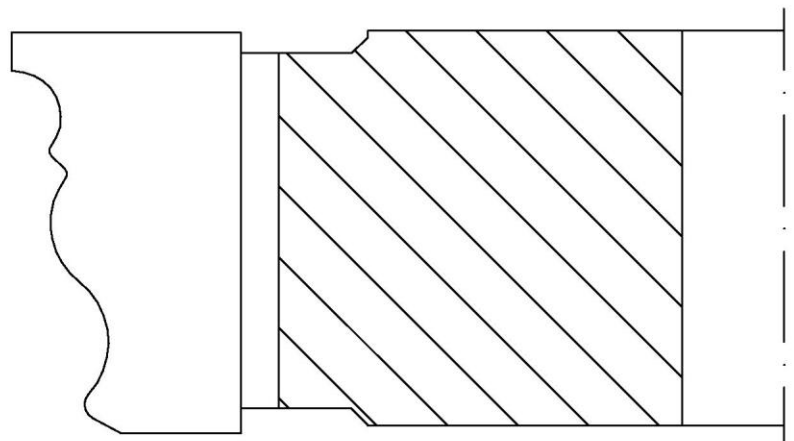
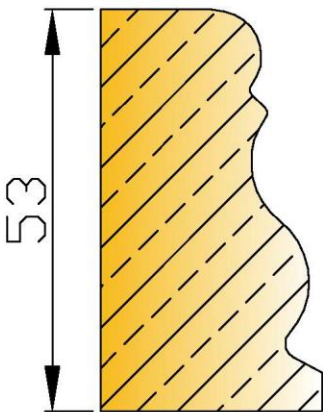

FK-254

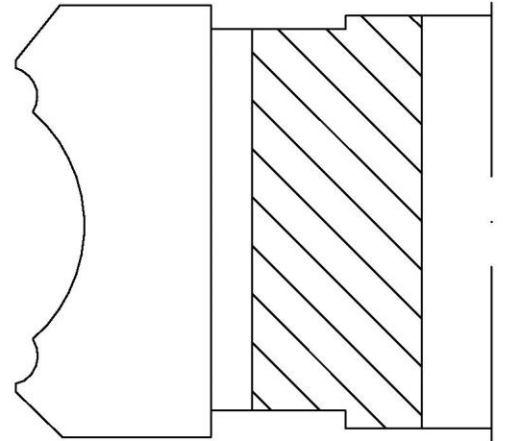
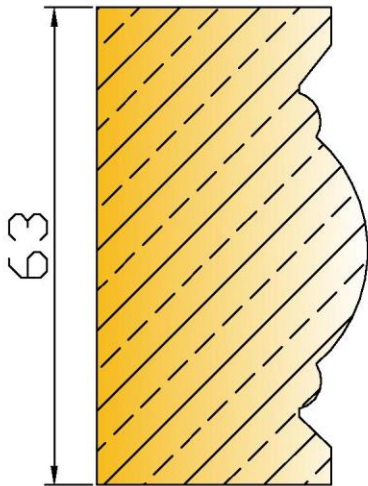

FK-255

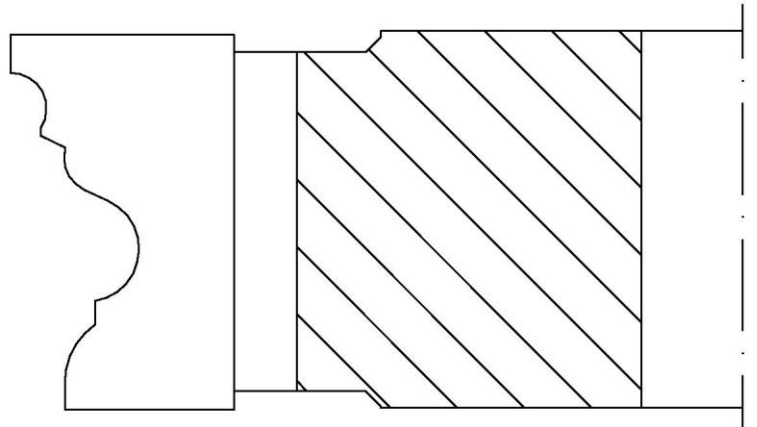
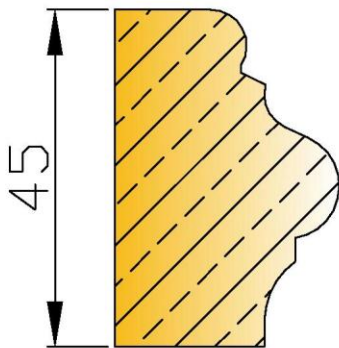

FK-256

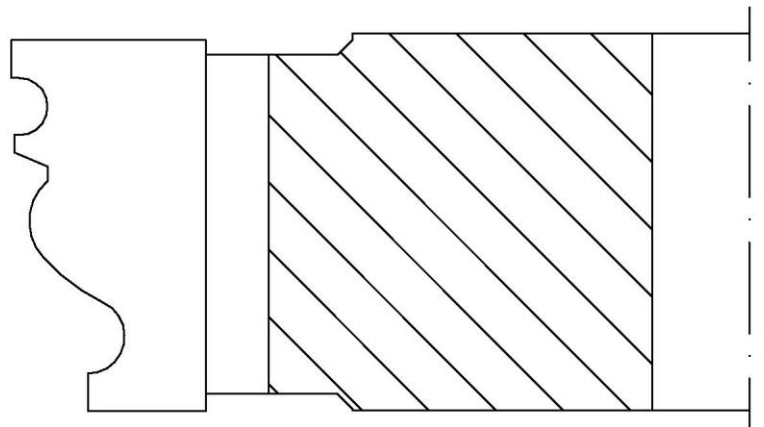
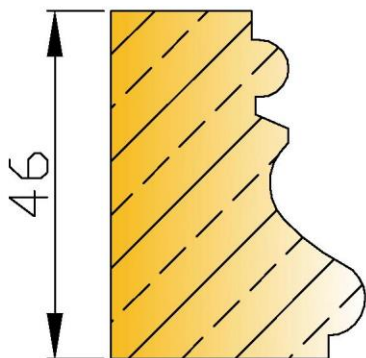

FK-257

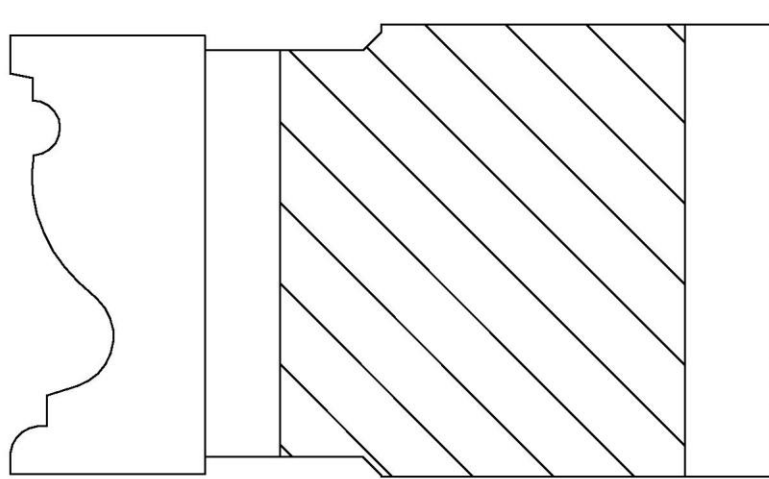
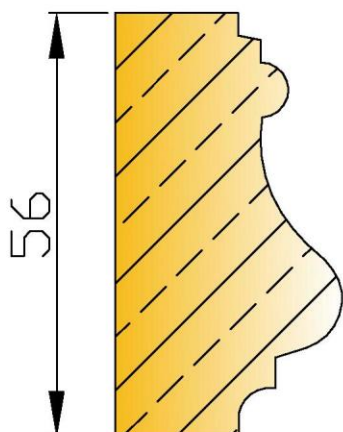

FK-258

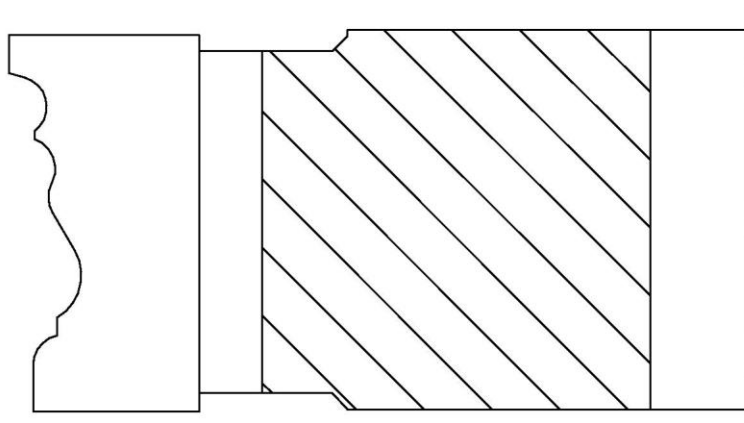
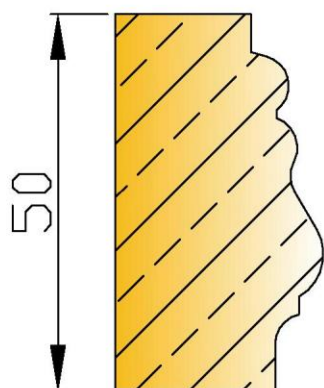

FK-259

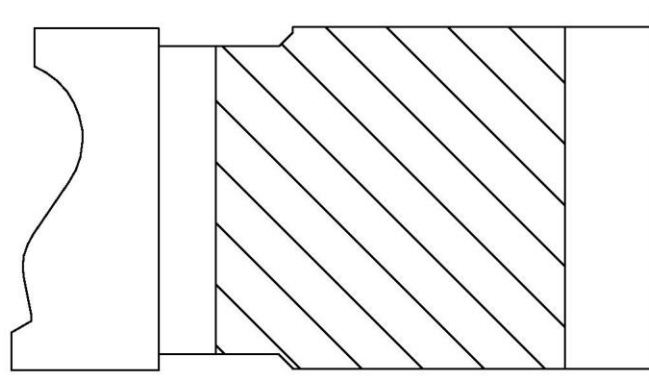
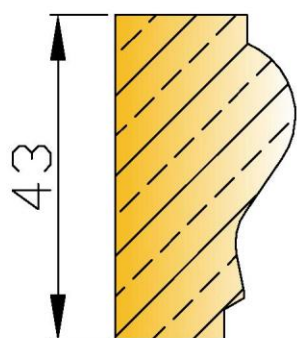

FK-260

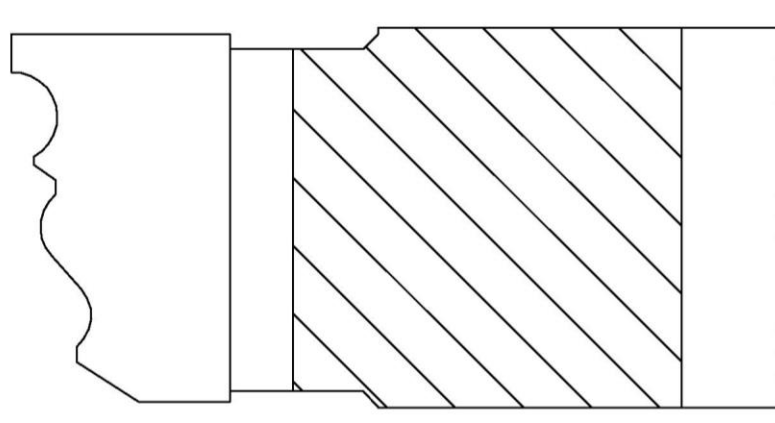
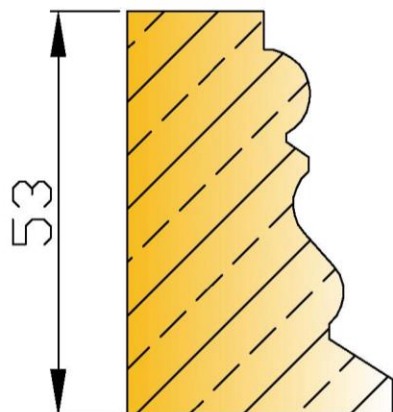

FK-261

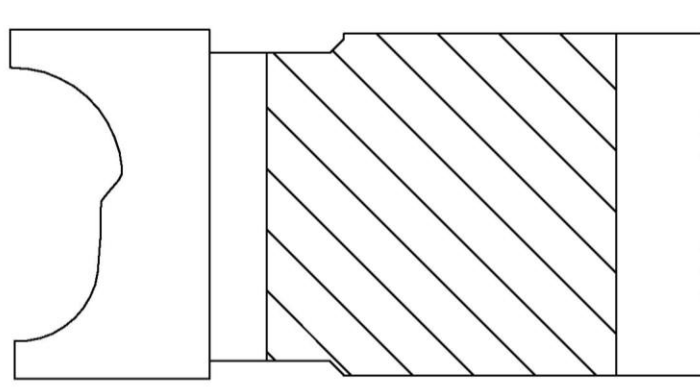
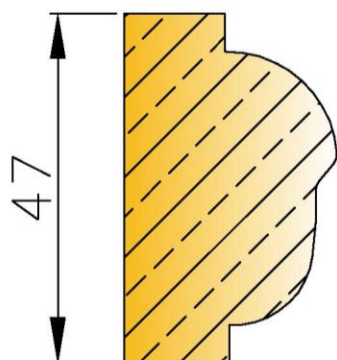

FK-262

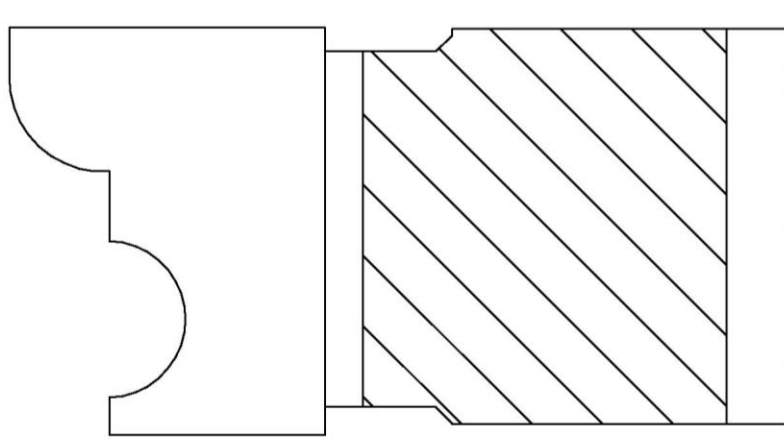
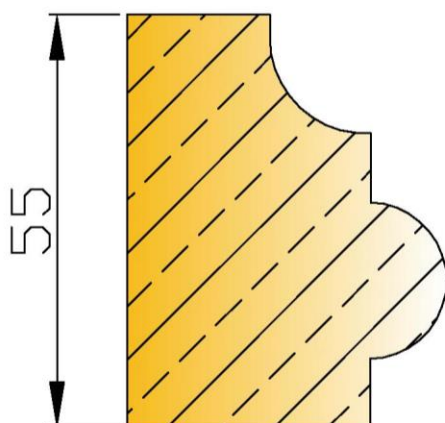

FK-263

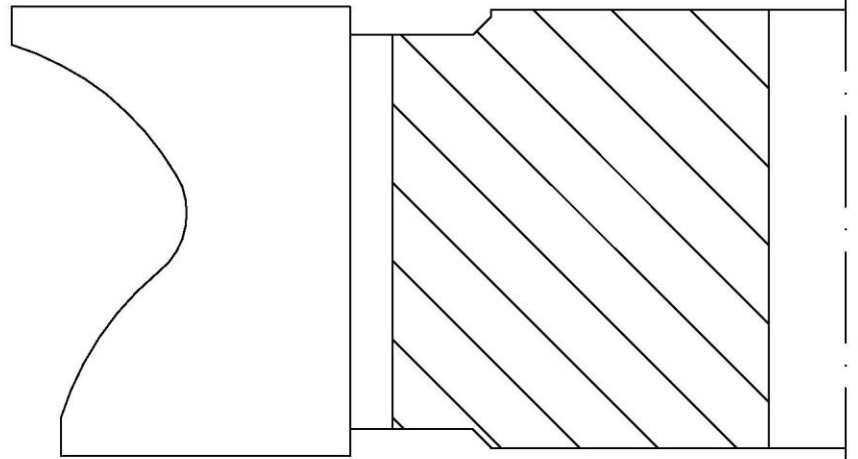
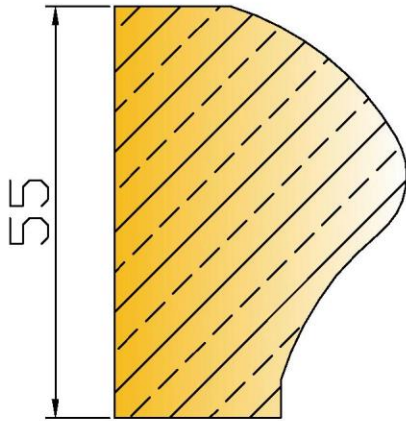

FK-264

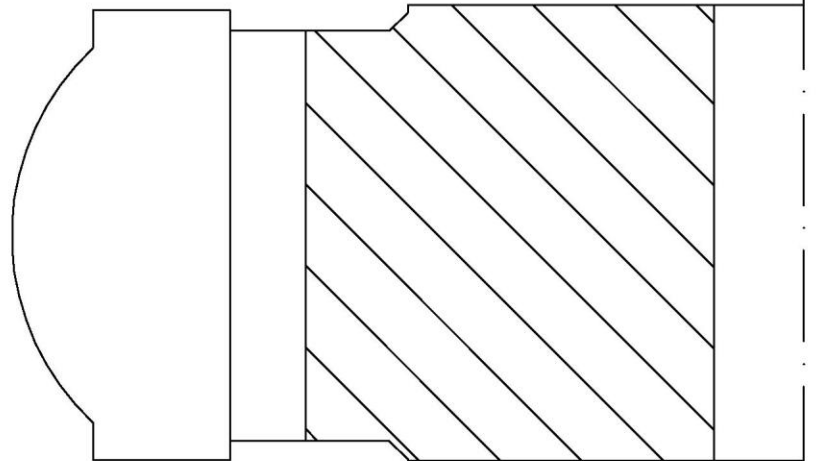
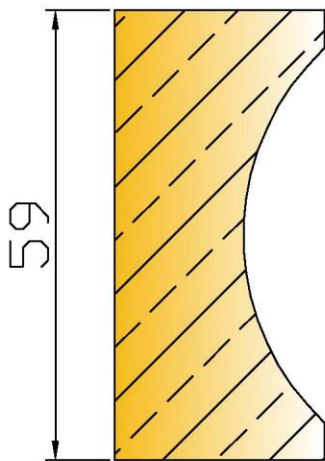

FK-265

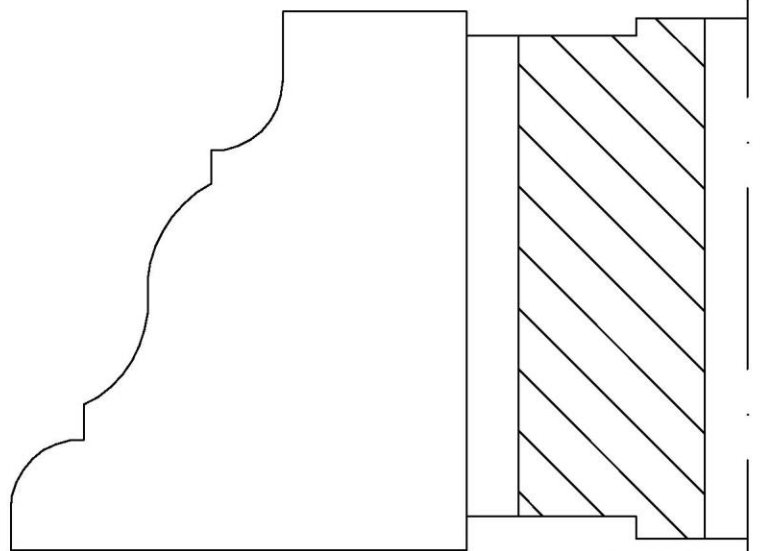
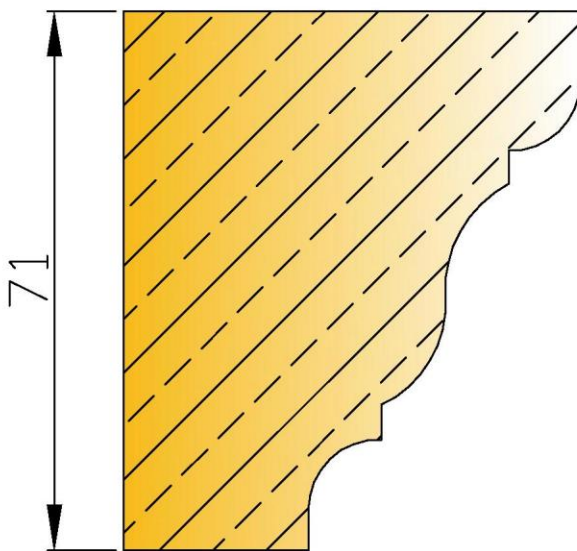

FK-266

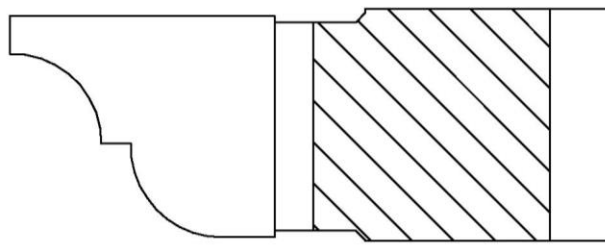
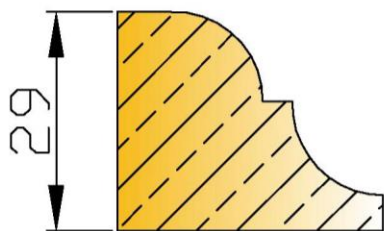

FK-267

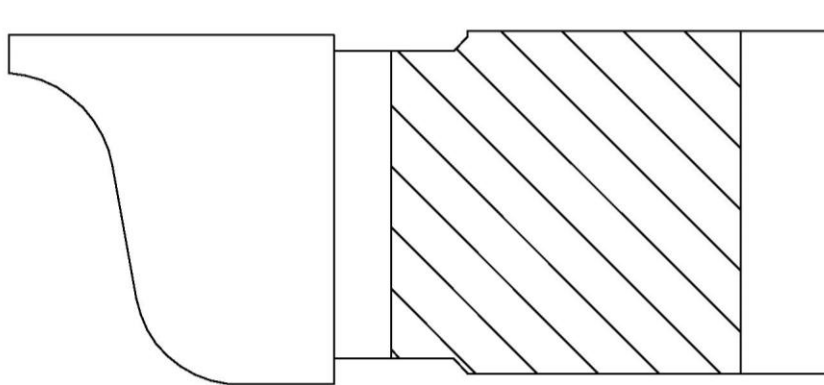
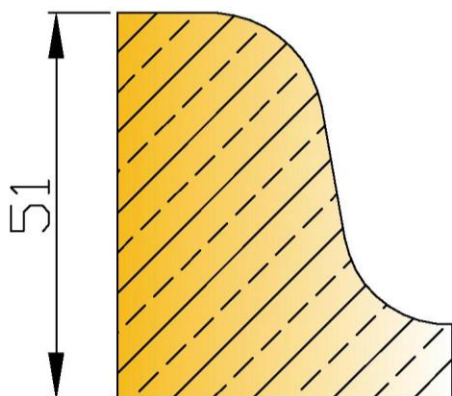

FK-268

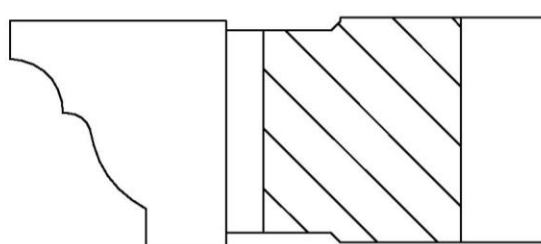
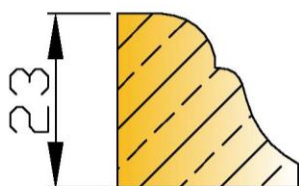

FK-269

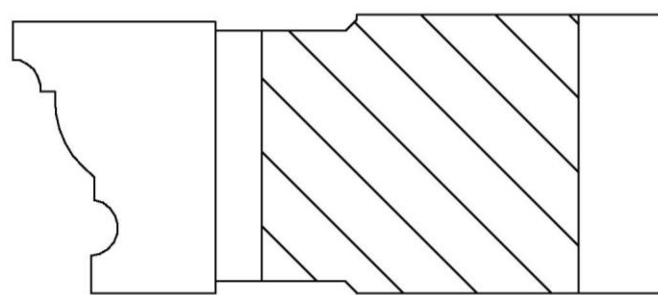
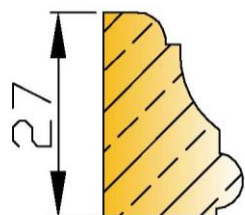

FK-270

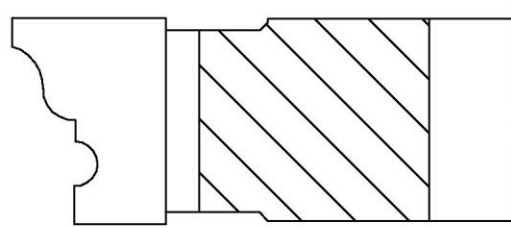
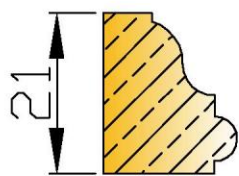

FK-271

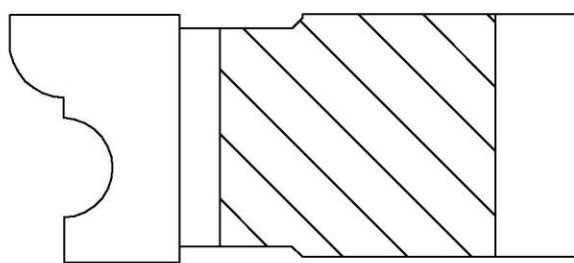
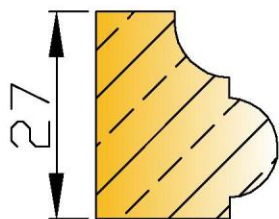

FK-272

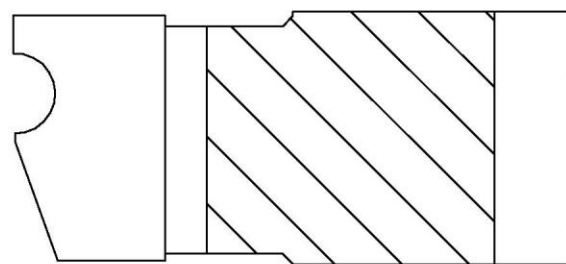
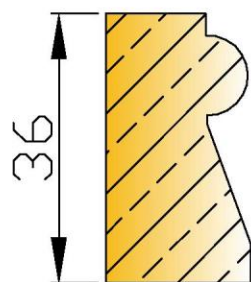

FK-273

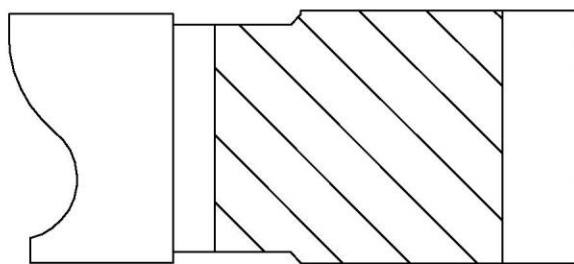
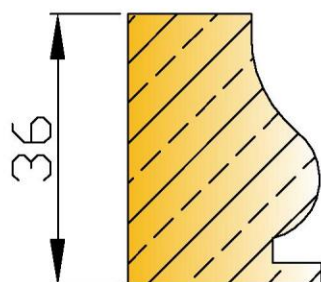

FK-274

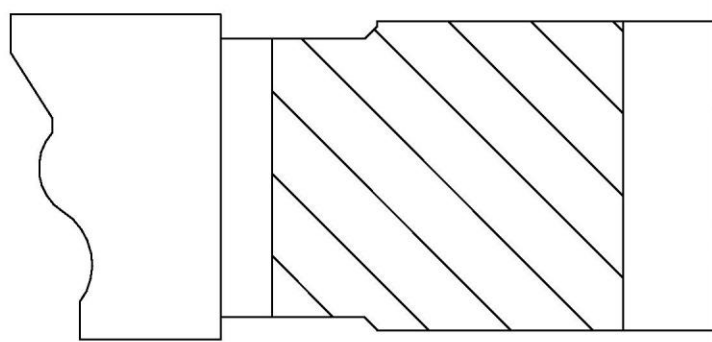
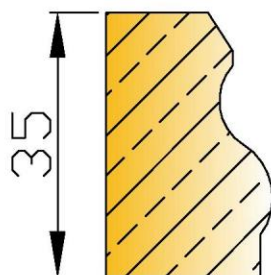

FK-275

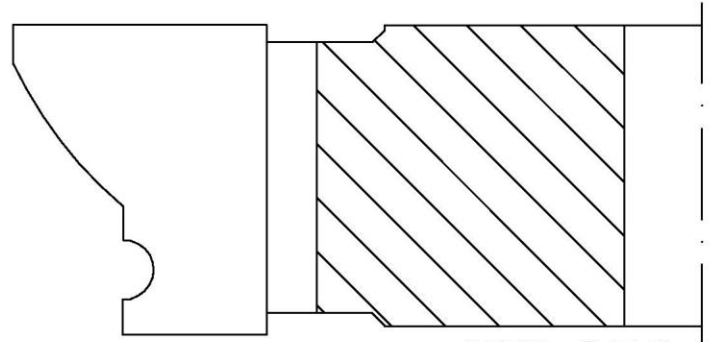
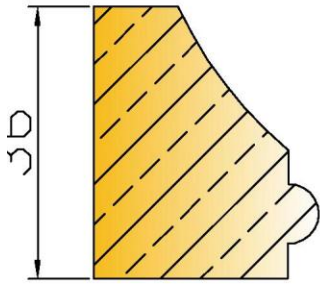

FK-276

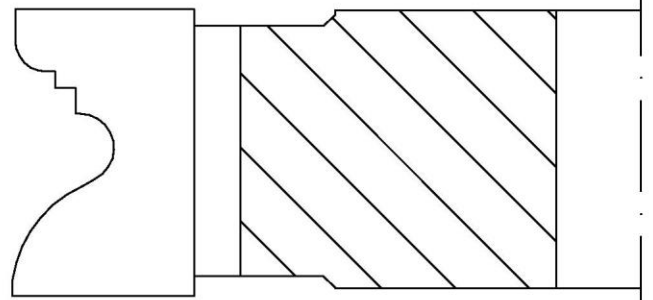
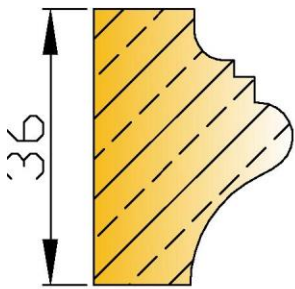

FK-277

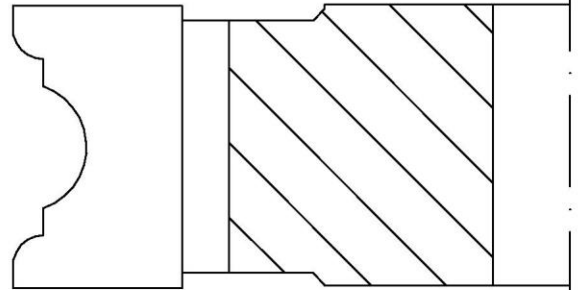
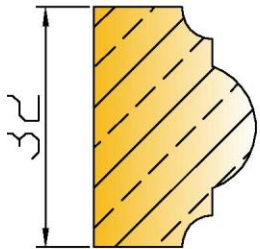

FK-278

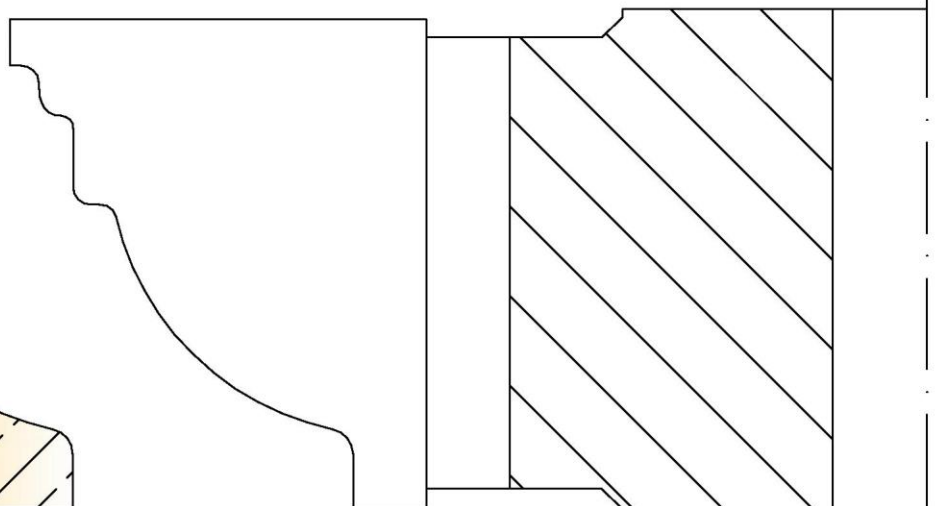
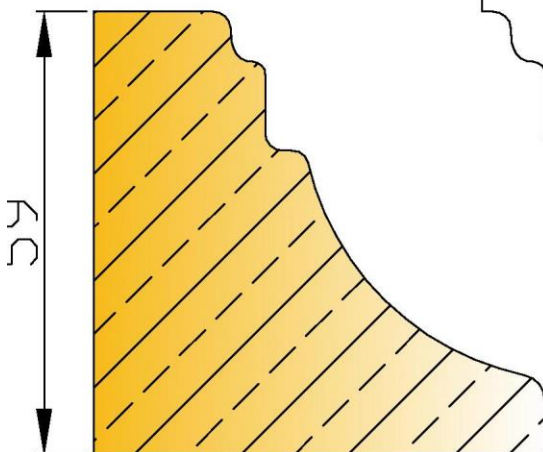

FK-279

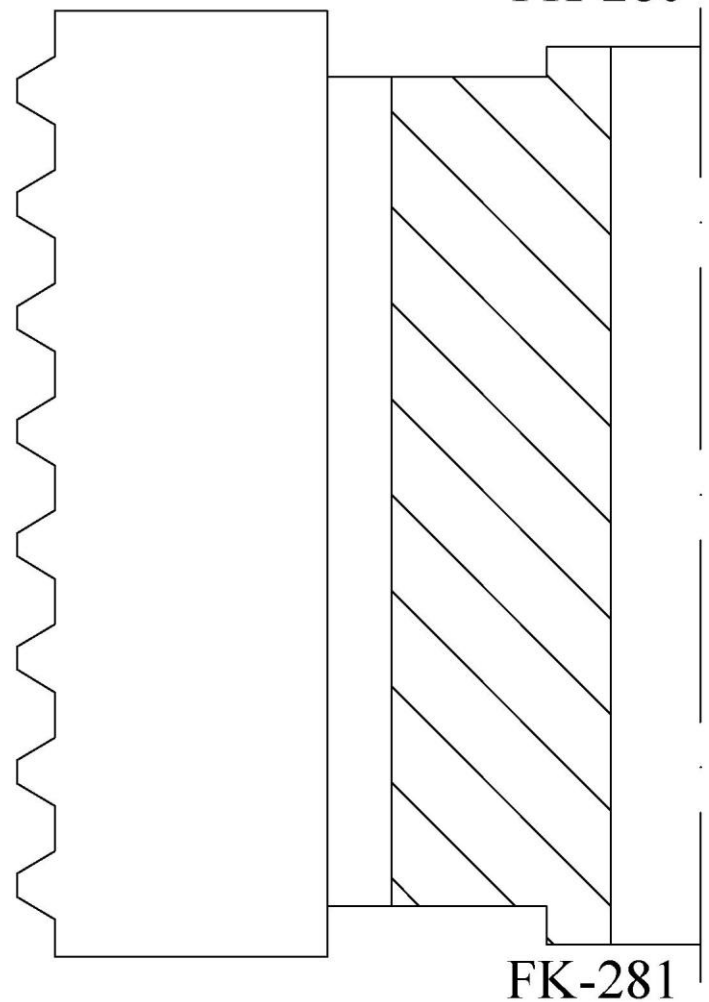
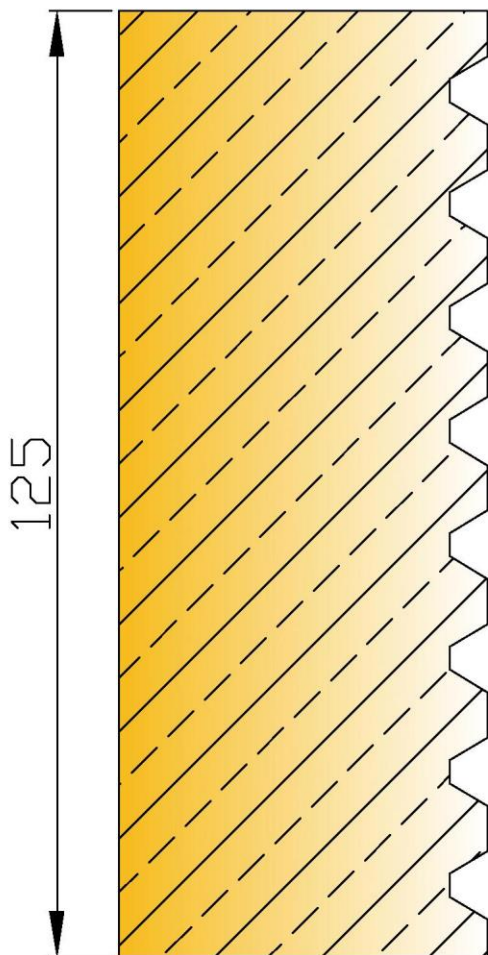
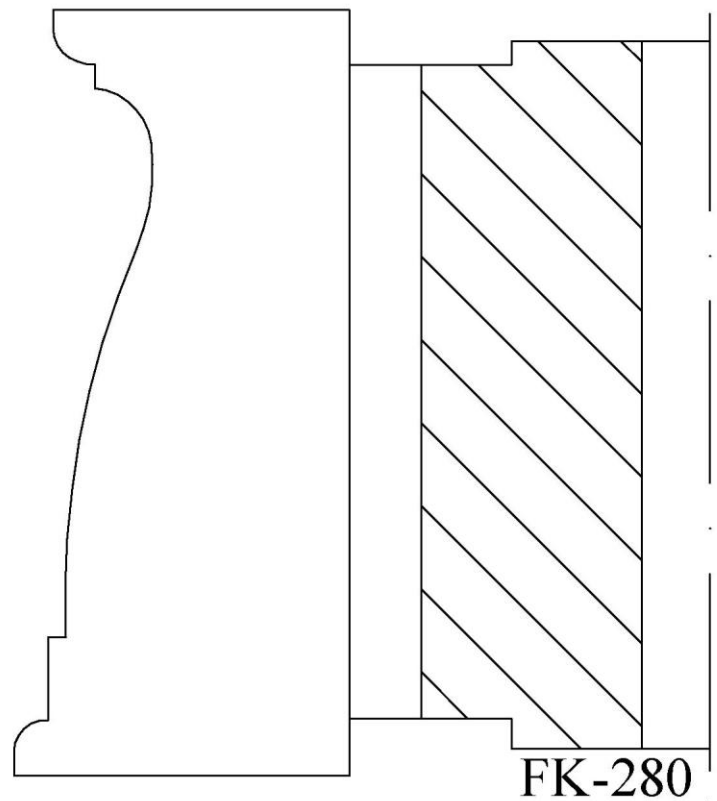
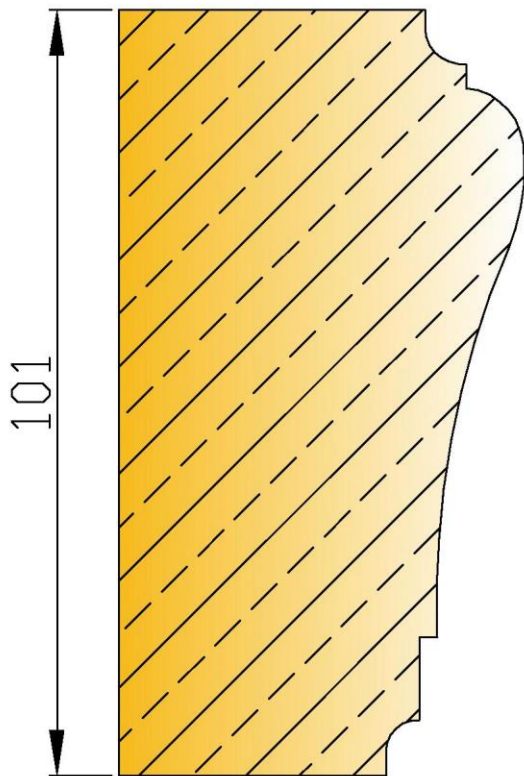

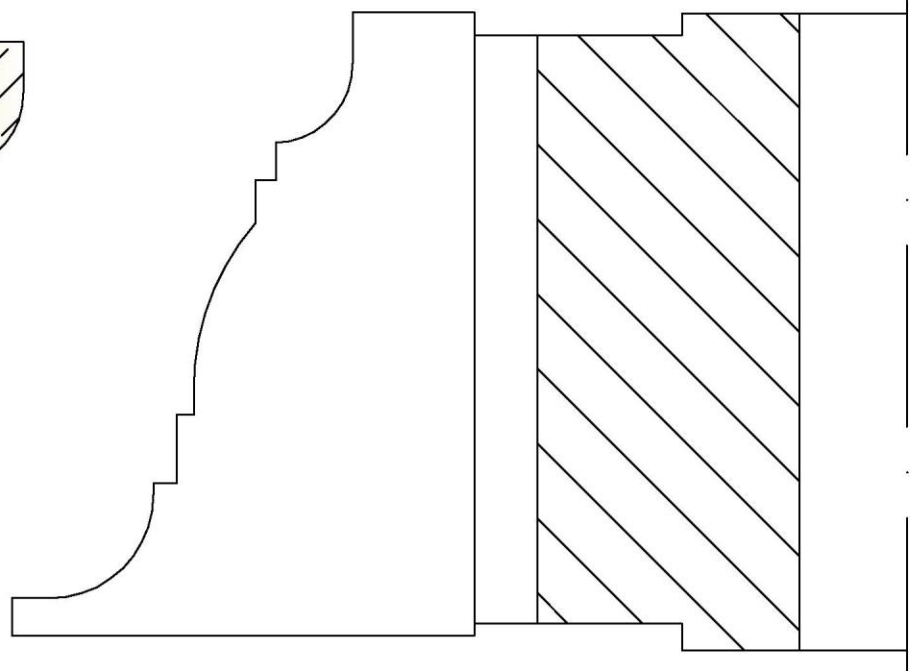
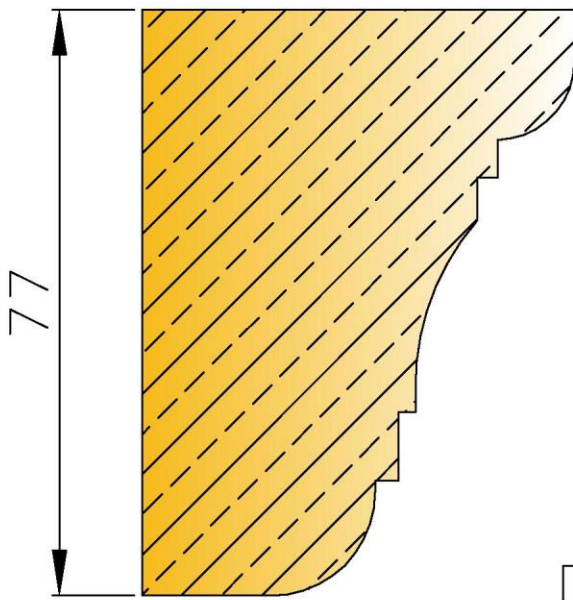

FK-282

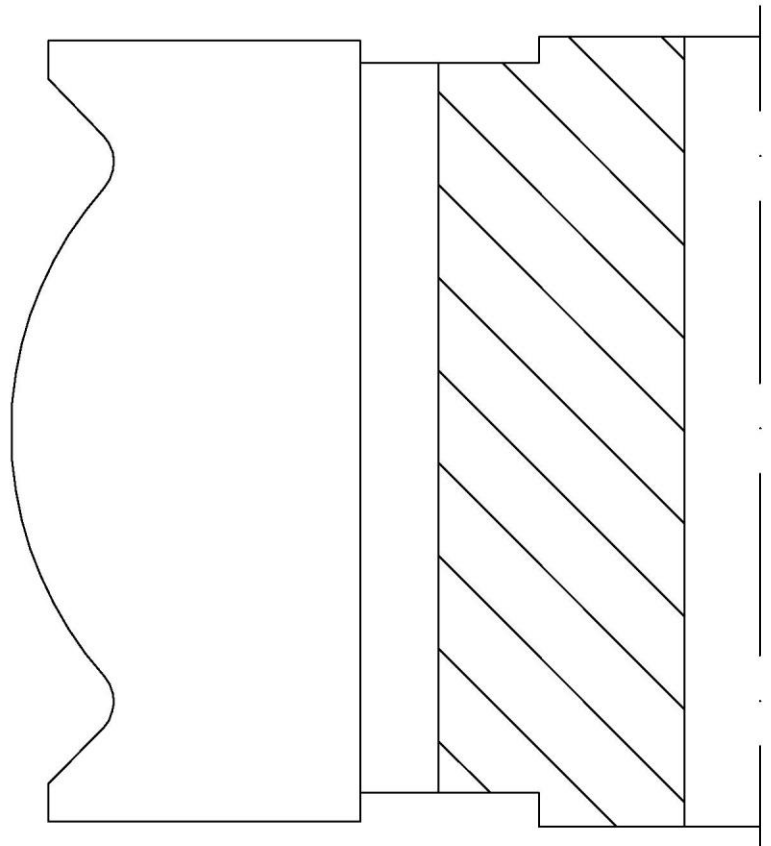
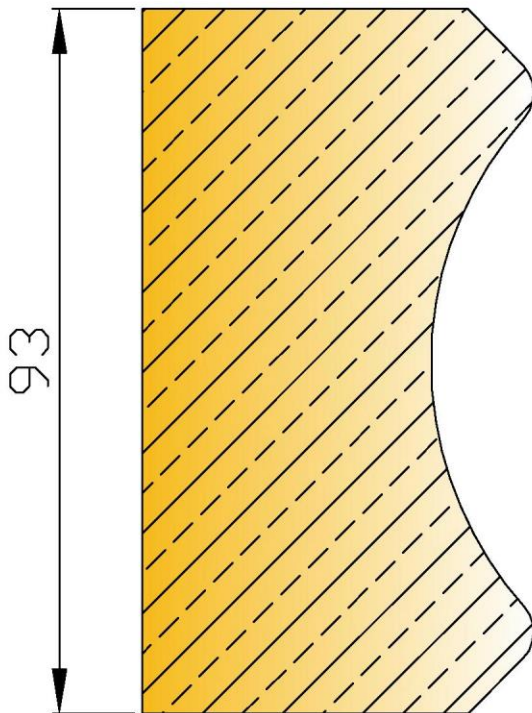

FK-283

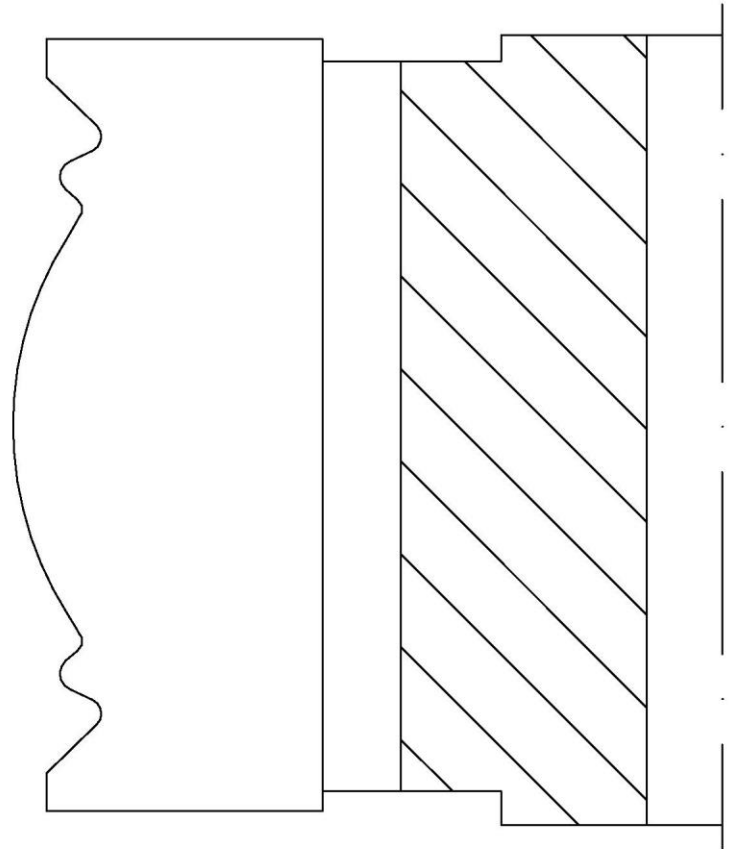
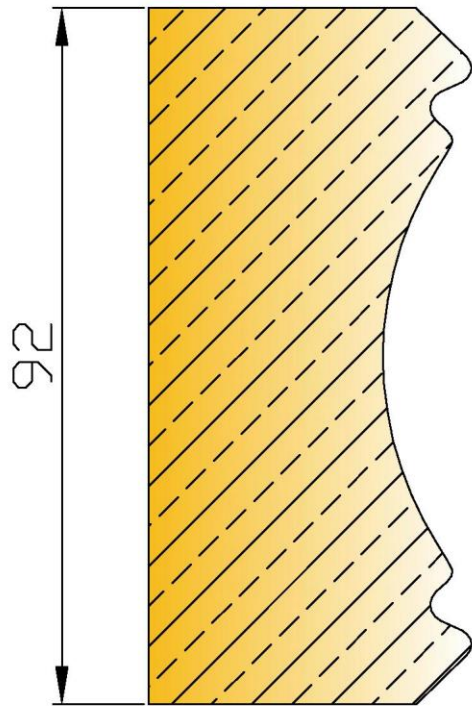

FK-284

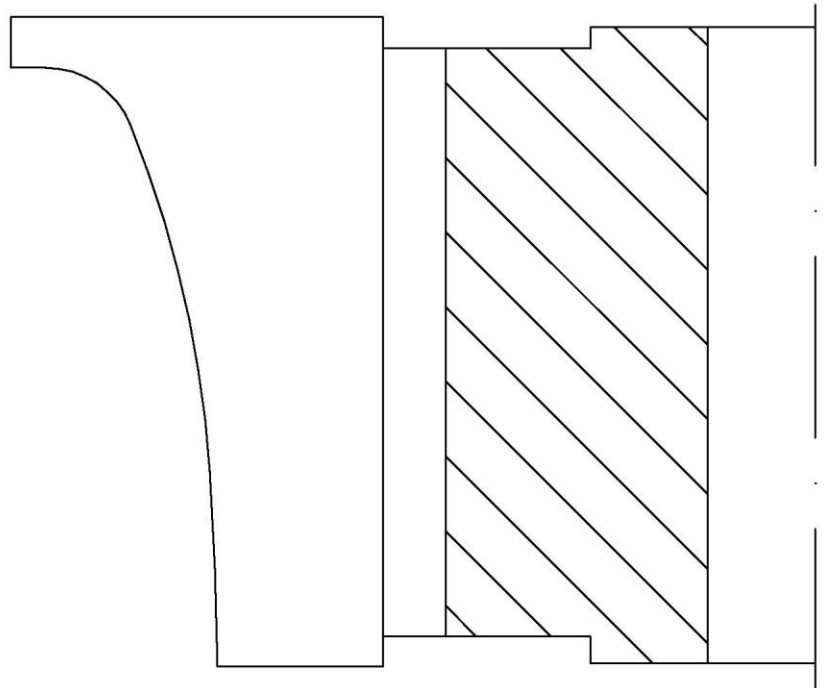
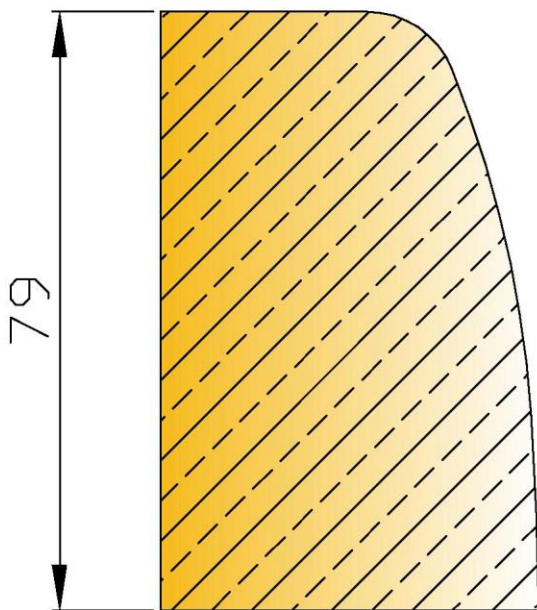

FK-285

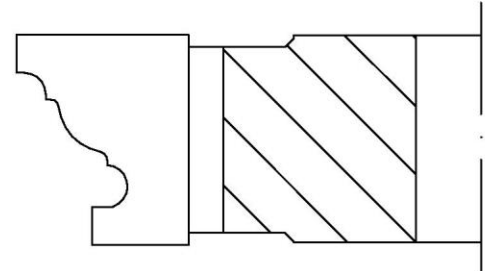
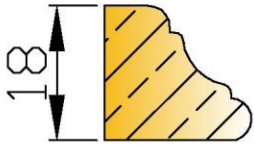

FK-286

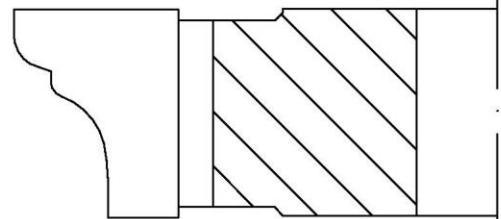
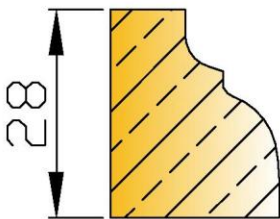

FK-287

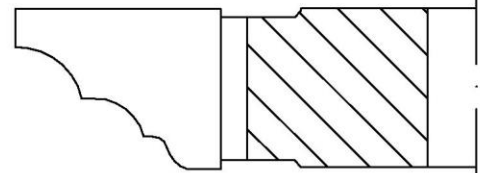
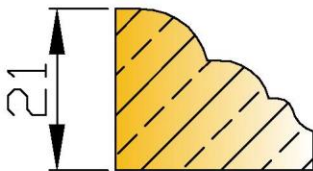

FK-288

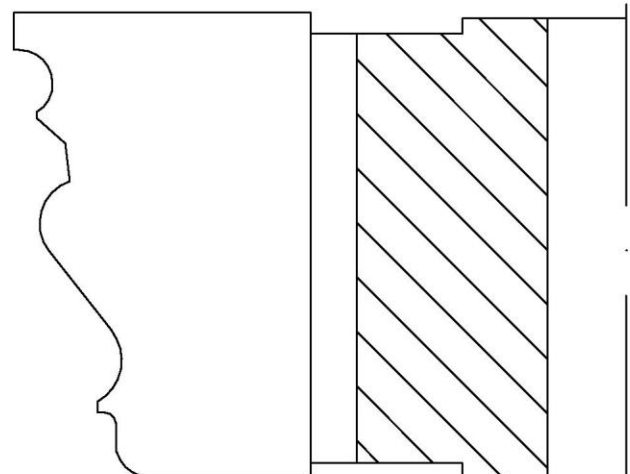
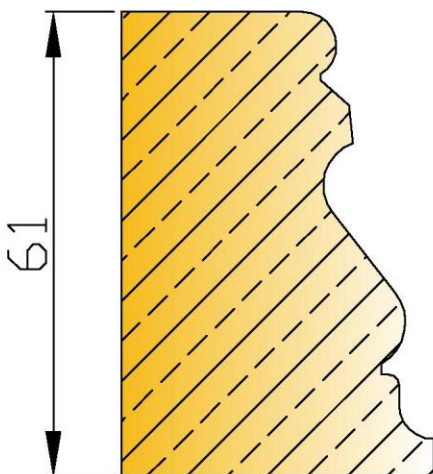

FK-289

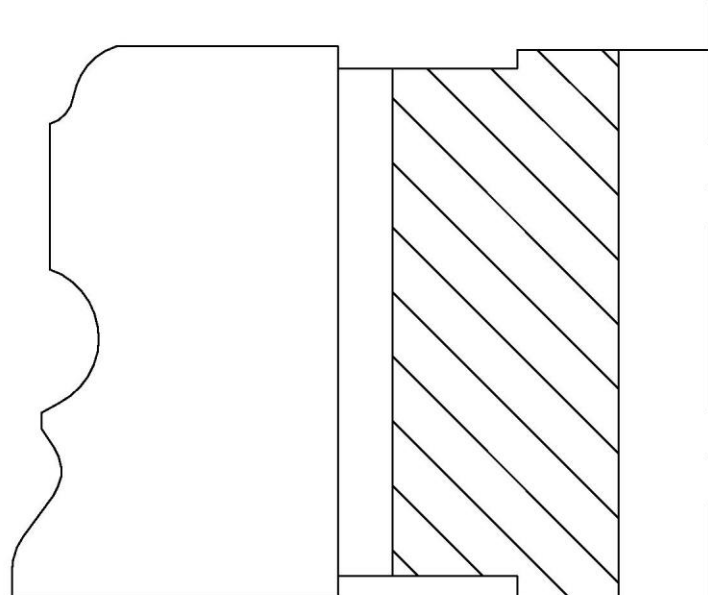
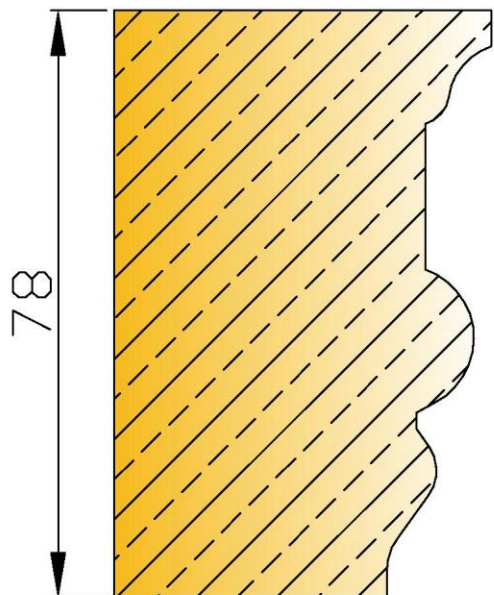

FK-290

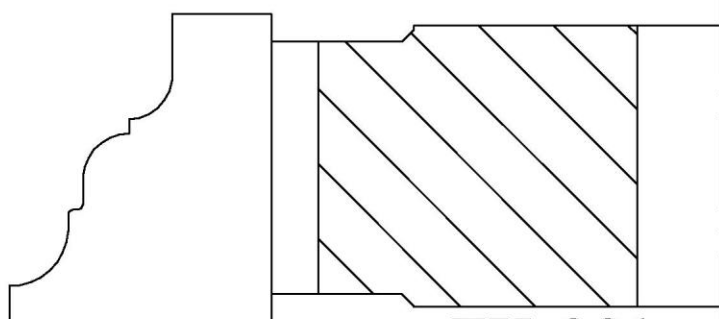
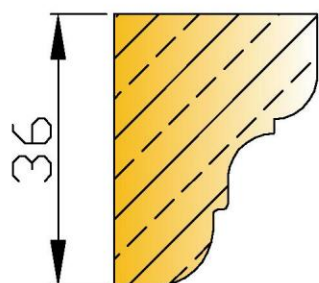

FK-291

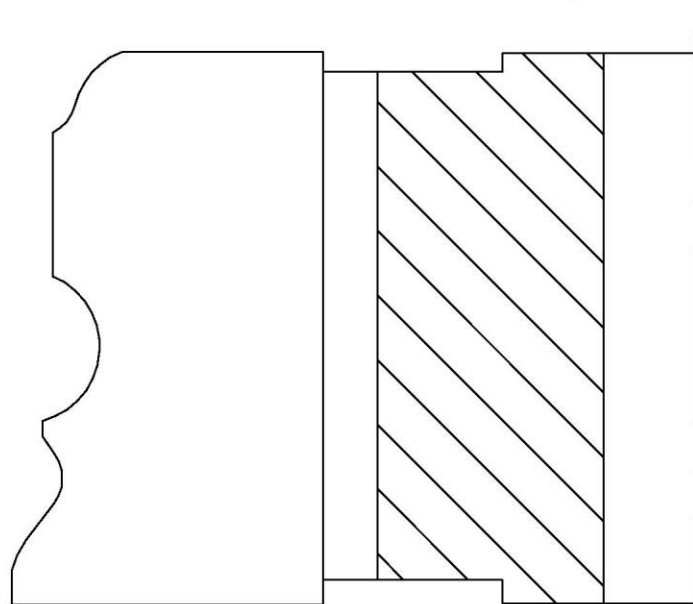
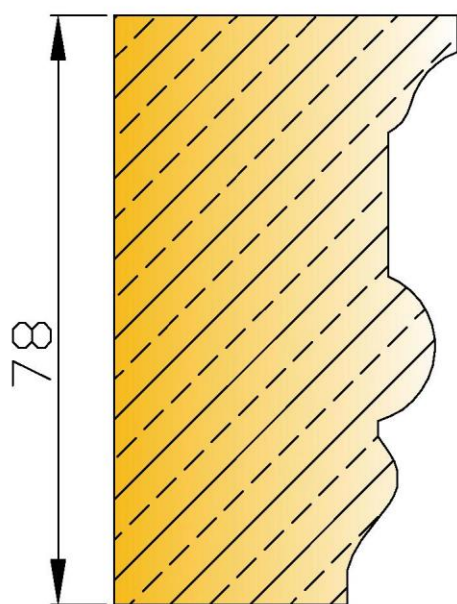

FK-292

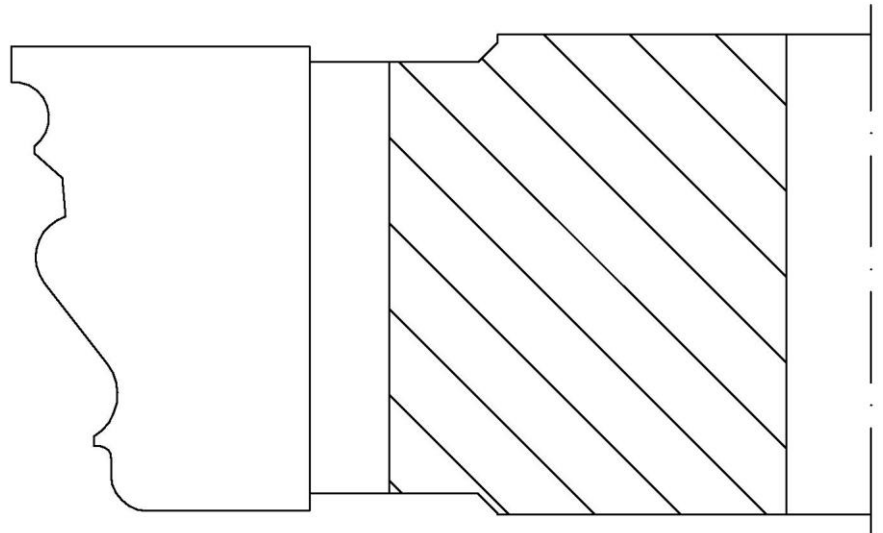
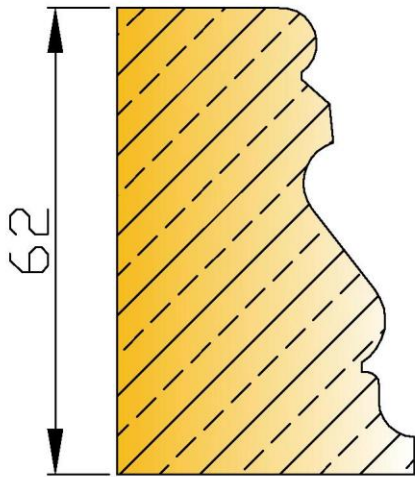

FK-293

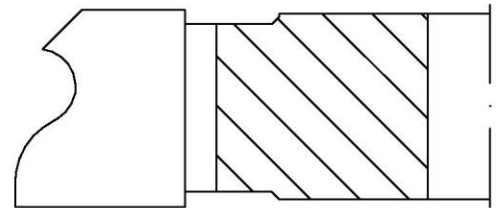
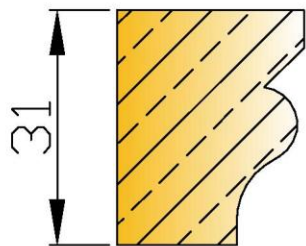

FK-294

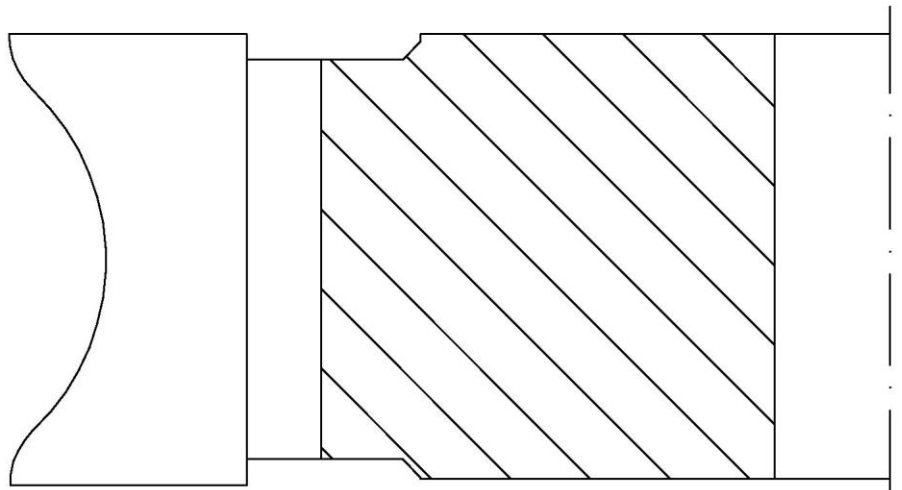
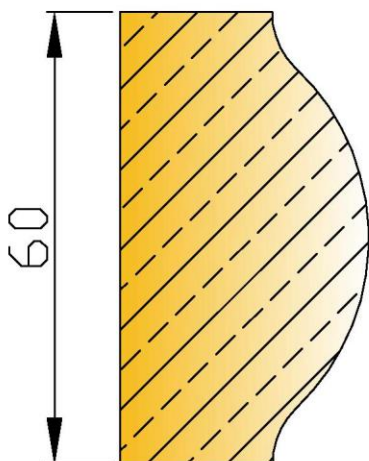

FK-295

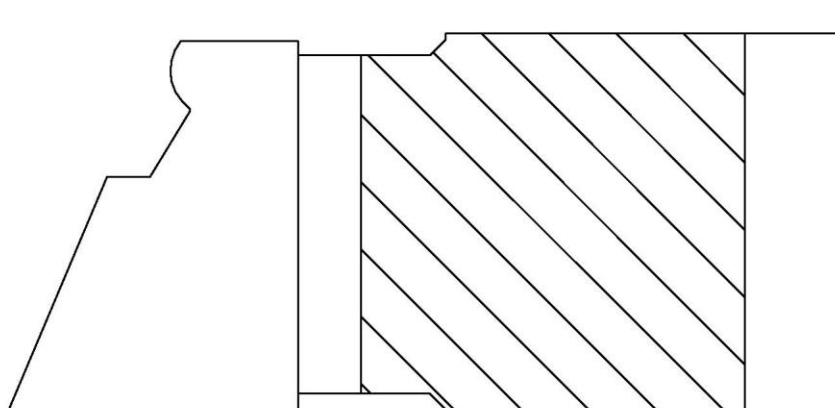
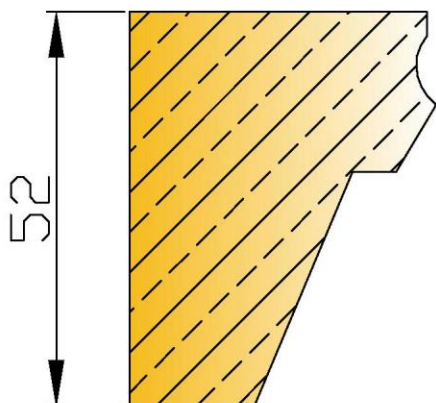

FK-296

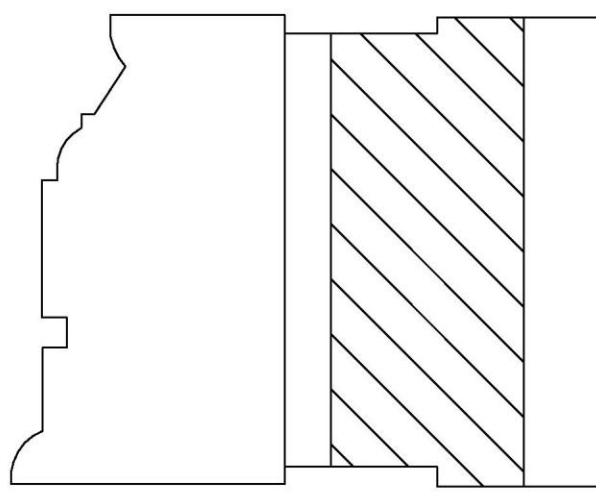
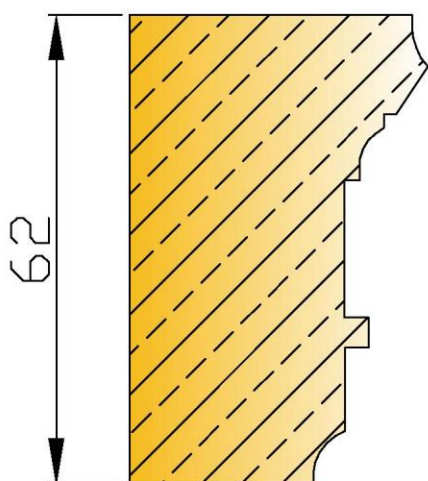

FK-297

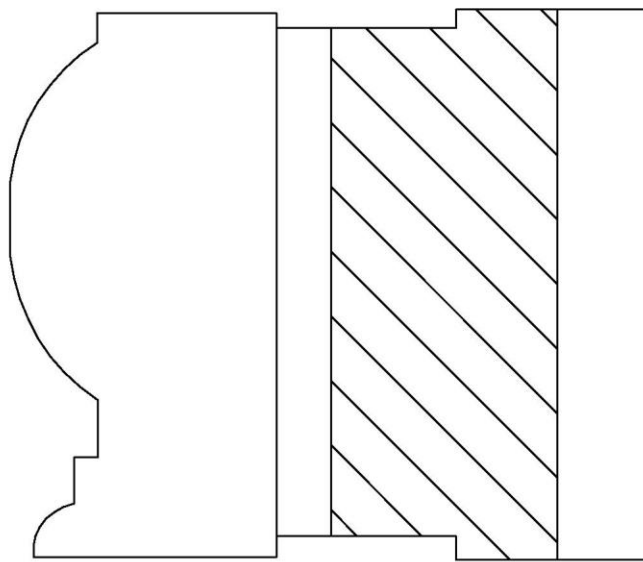
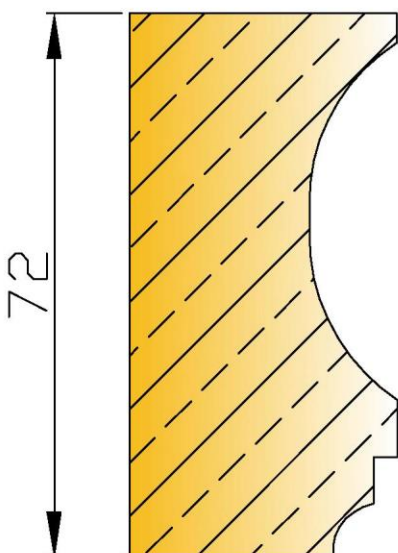

FK-298

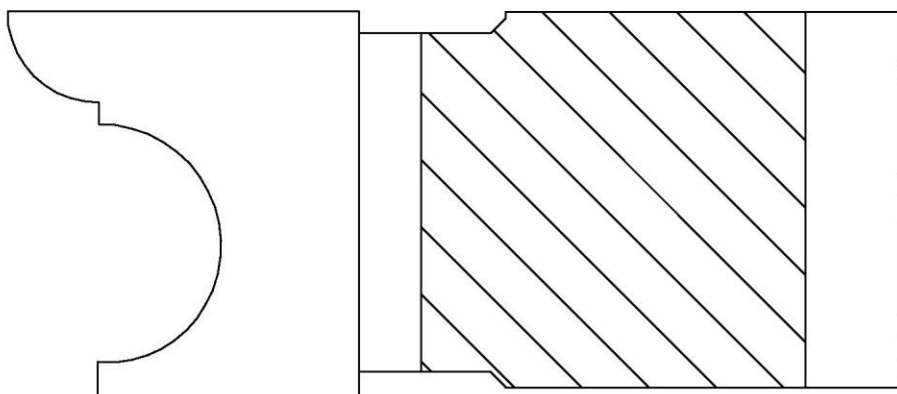
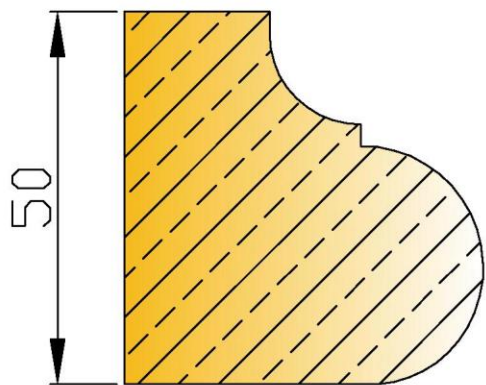

FK-299

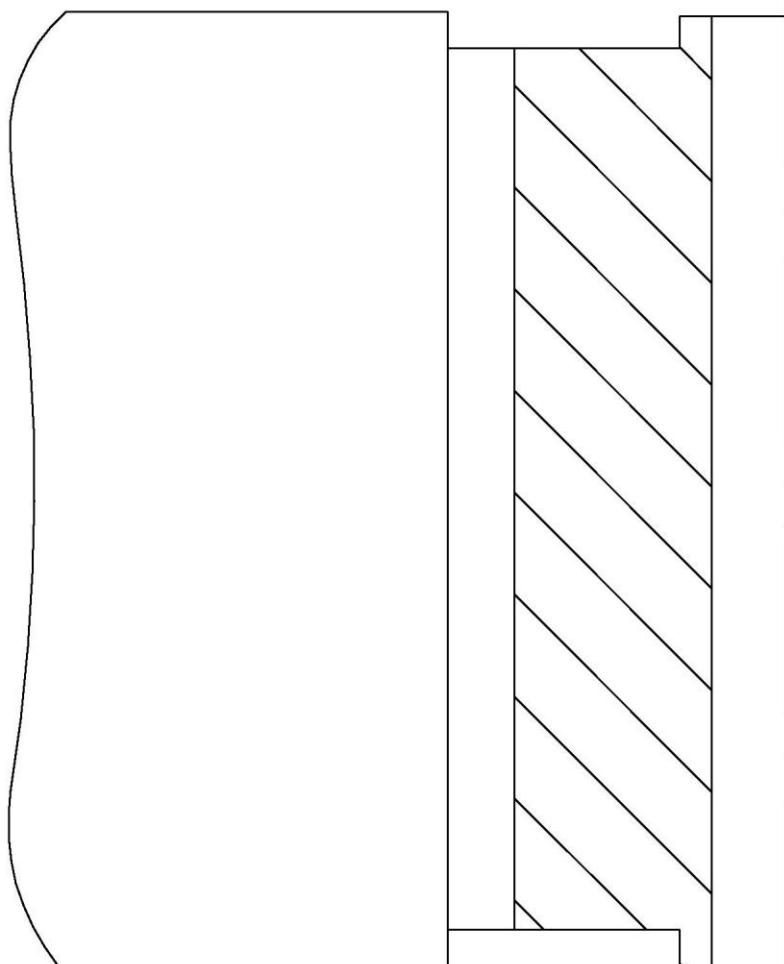
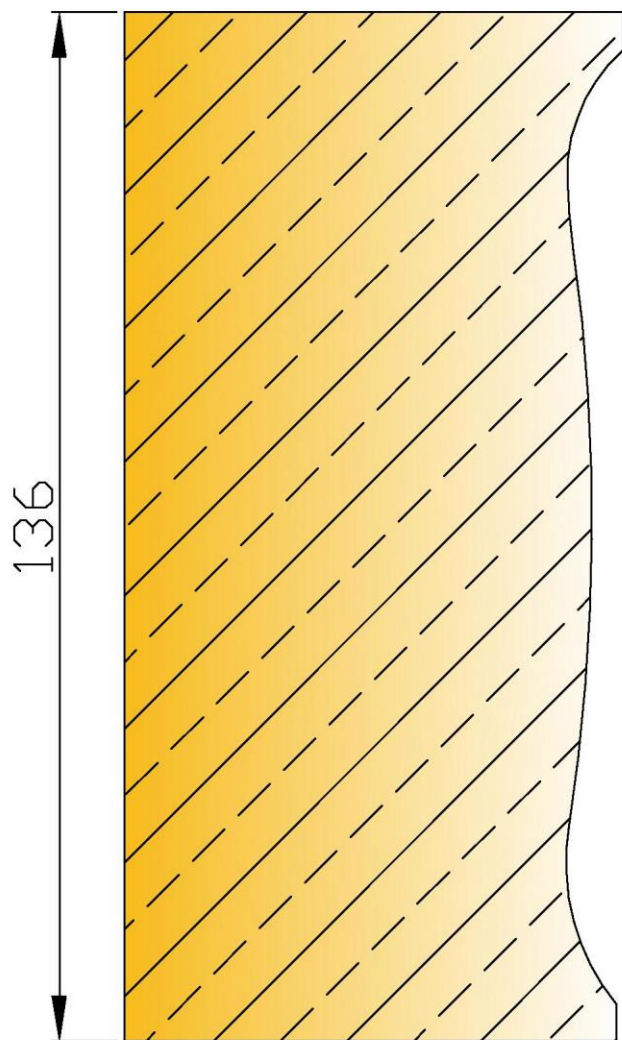

FK-300

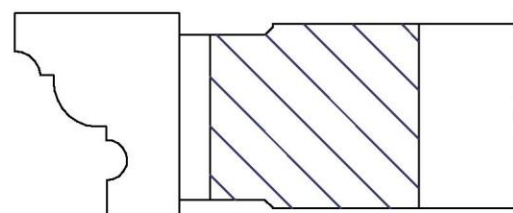

FK-301

62

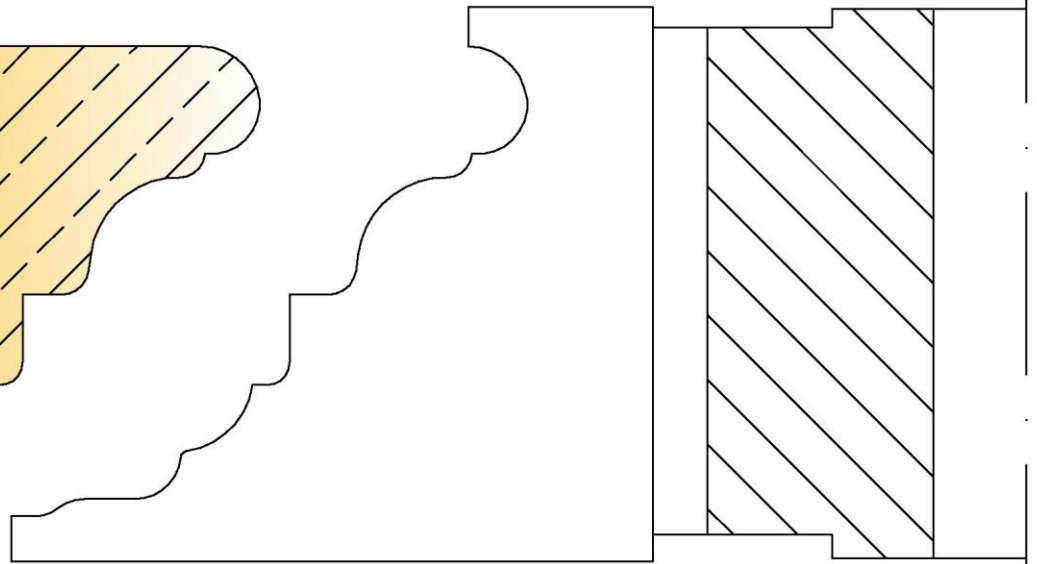
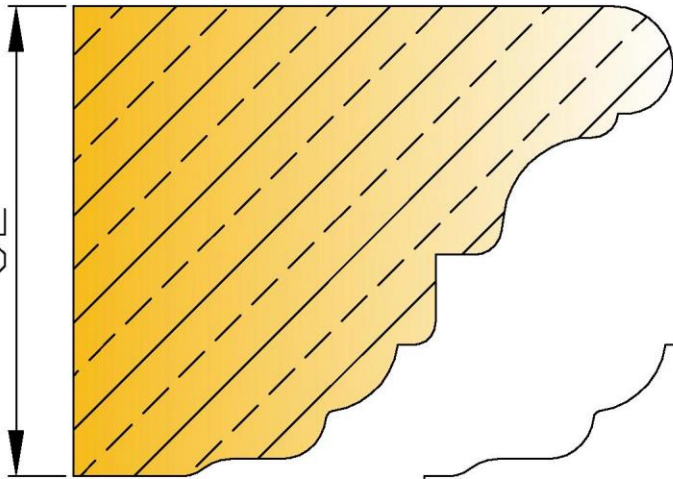

FK-302

42

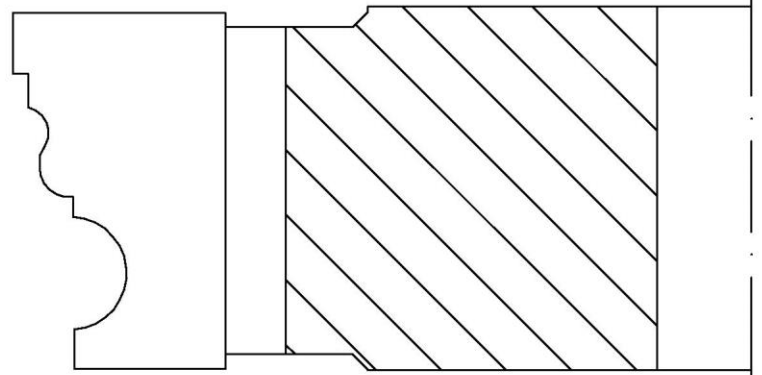
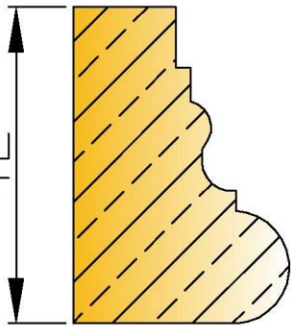

FK-303

54

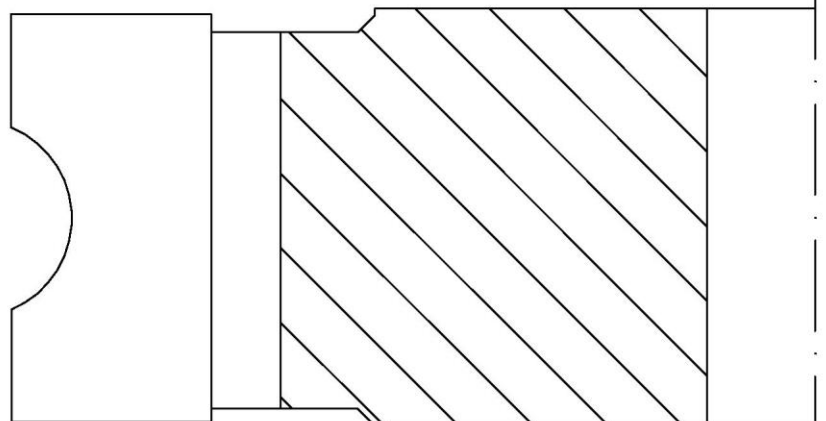
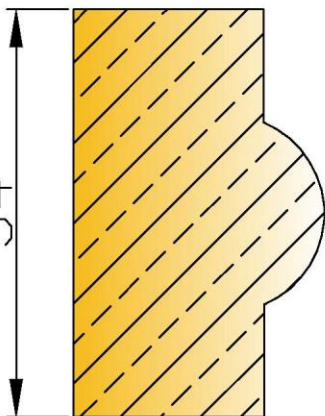

FK-304

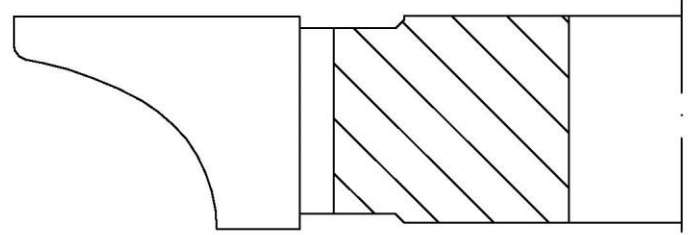
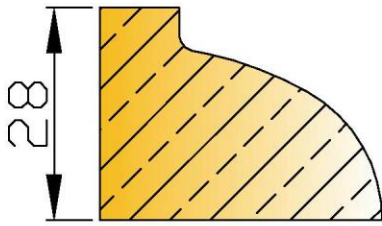

FK-305

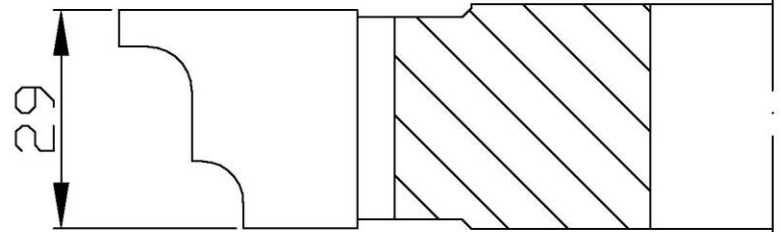
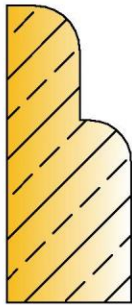

FK-306

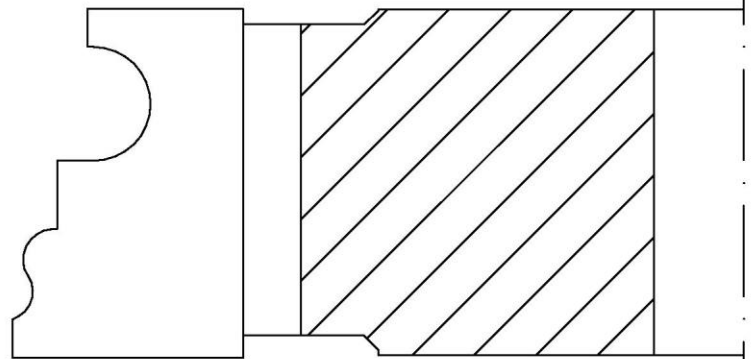
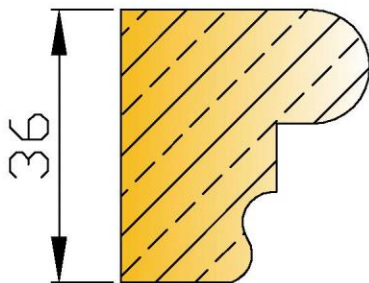

FK-307

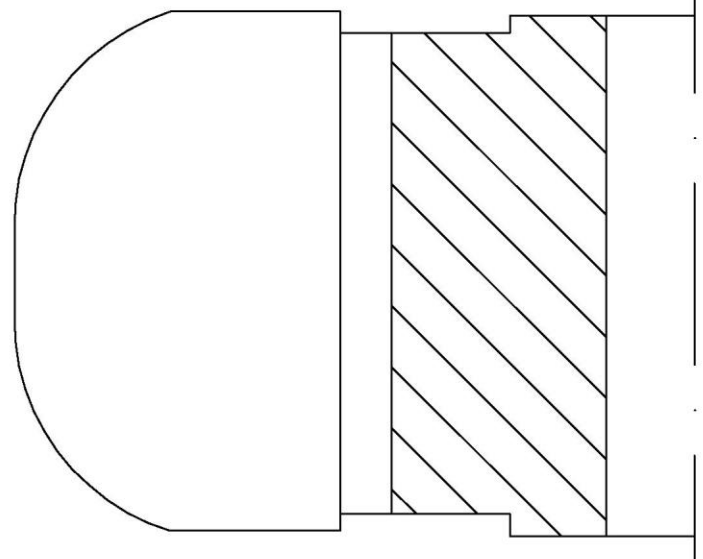
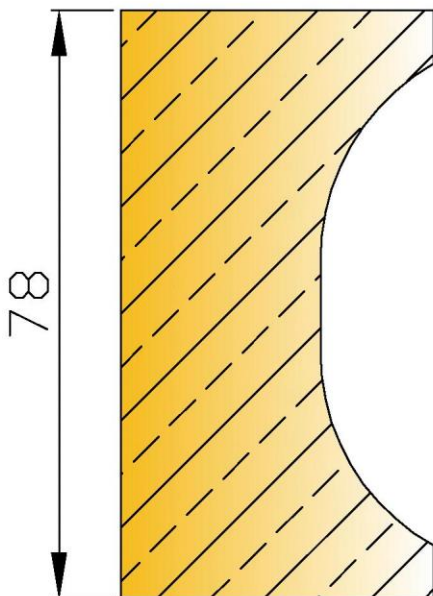

FK-308

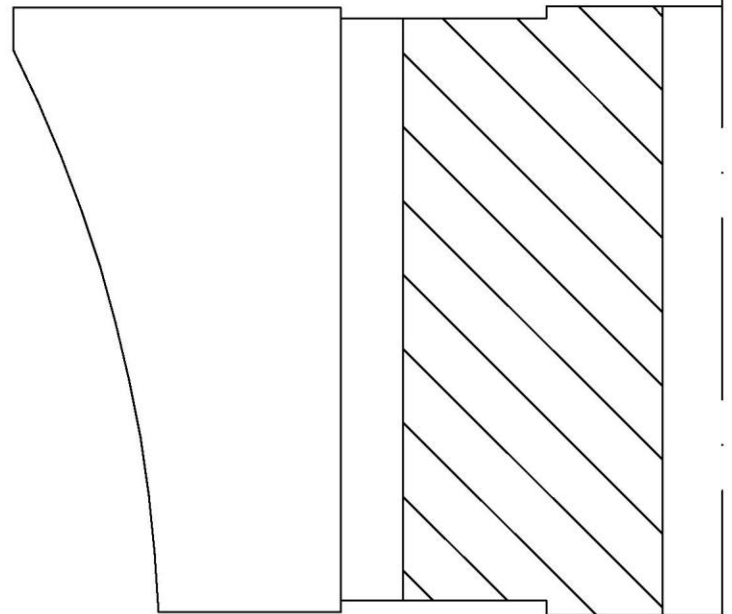
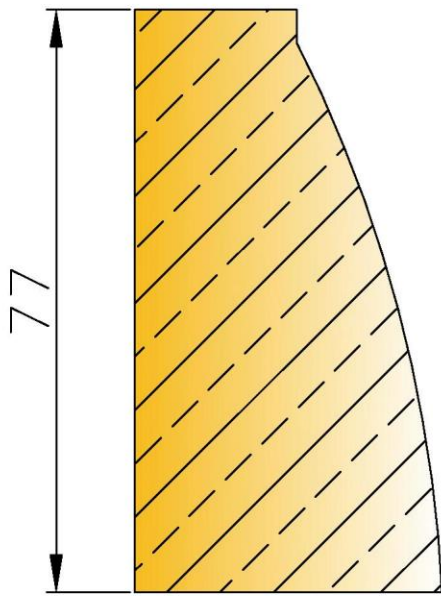

FK-309

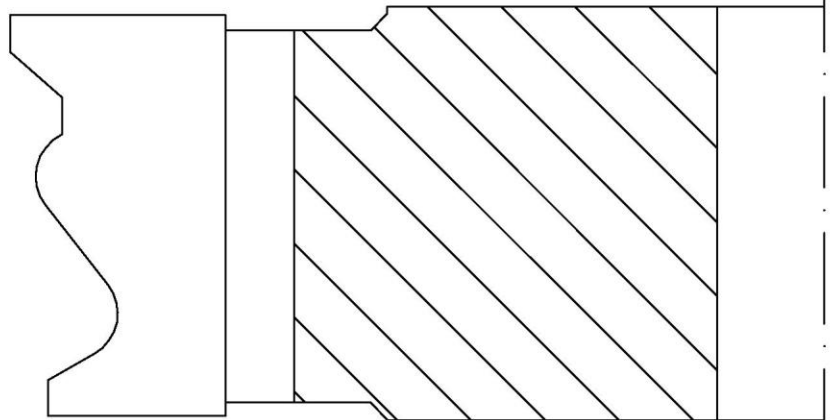
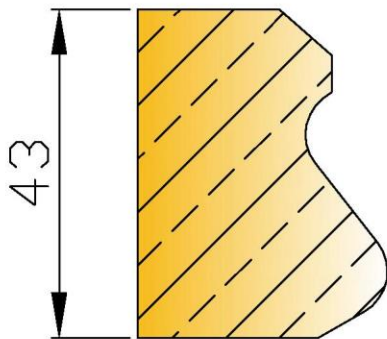

FK-310

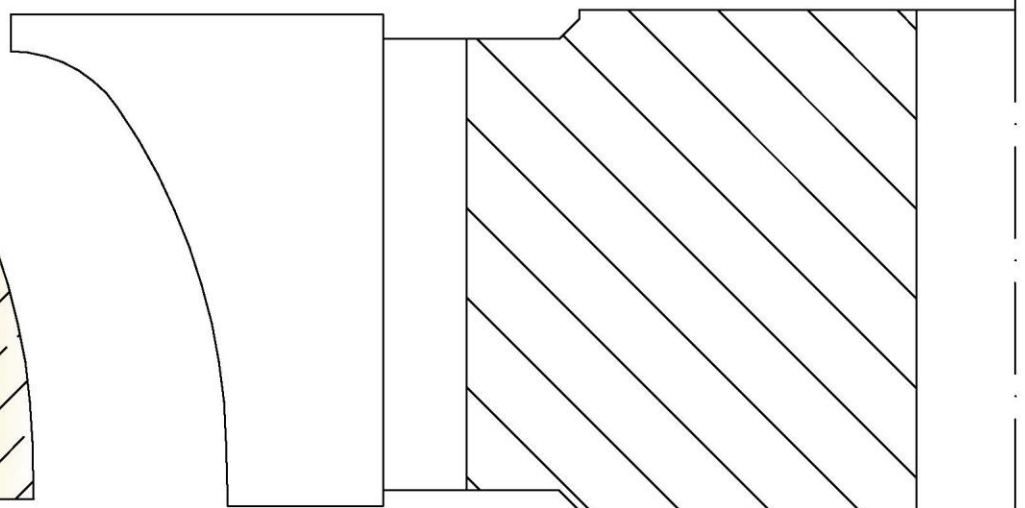
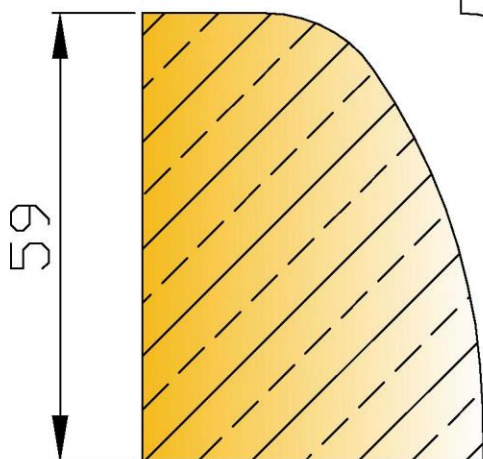

FK-311

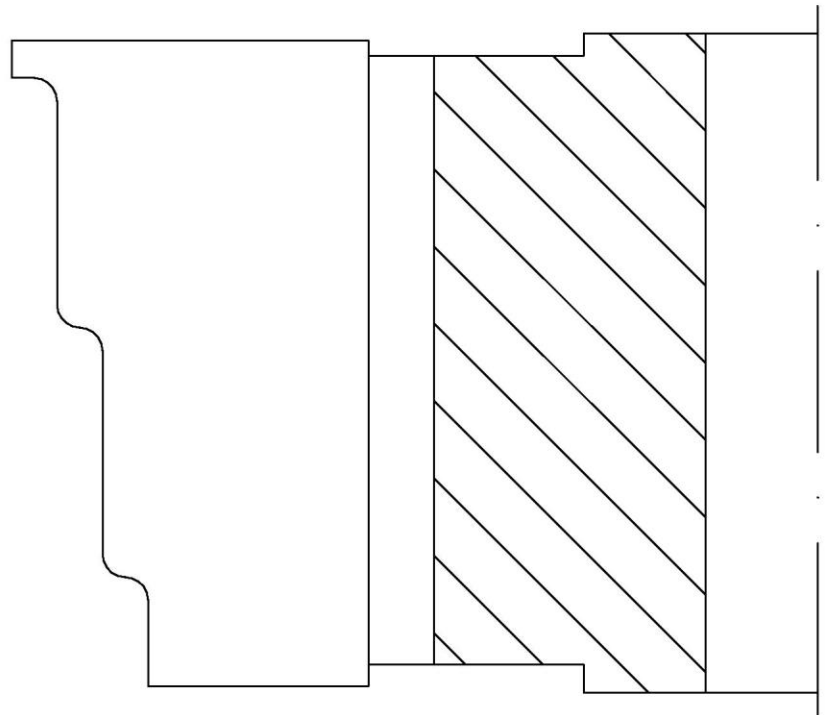
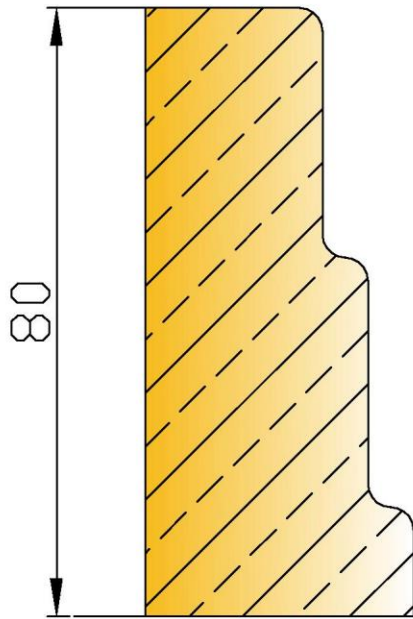

FK-312

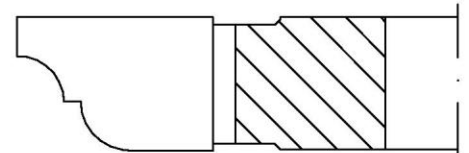
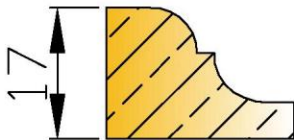

FK-313

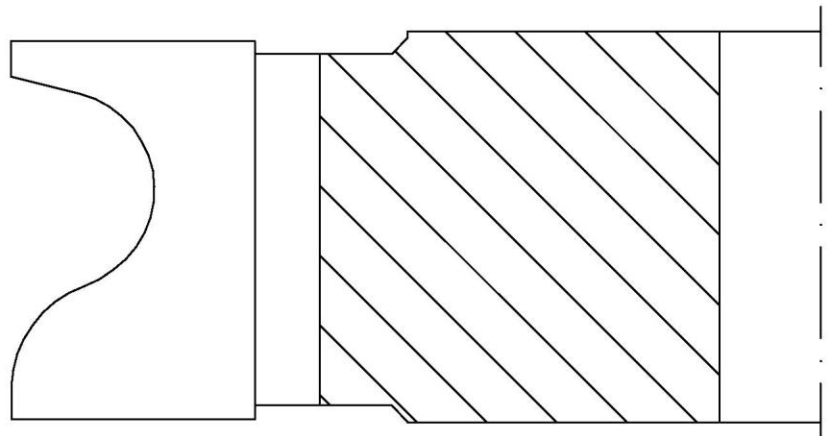
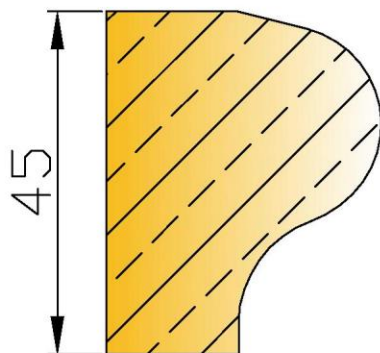

FK-314

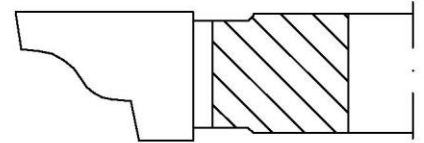
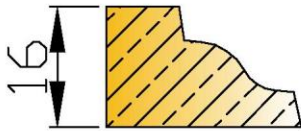

FK-315

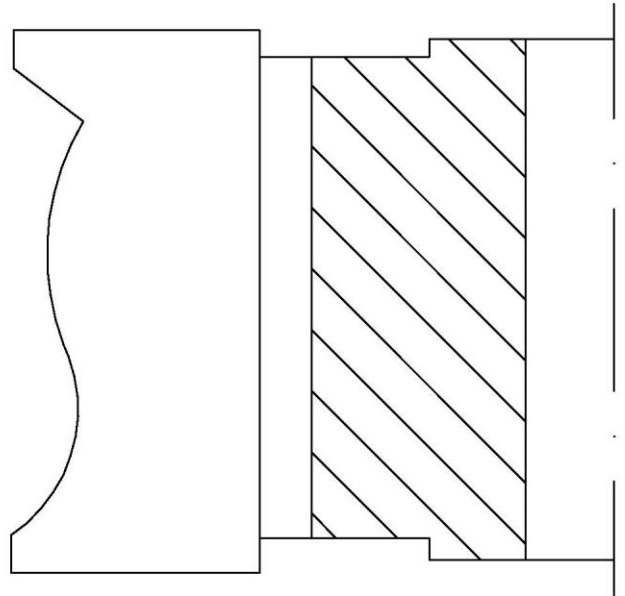
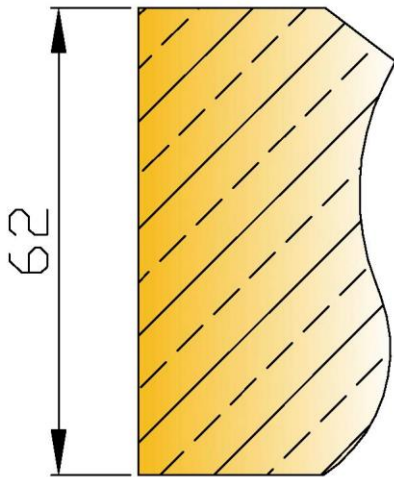

FK-316

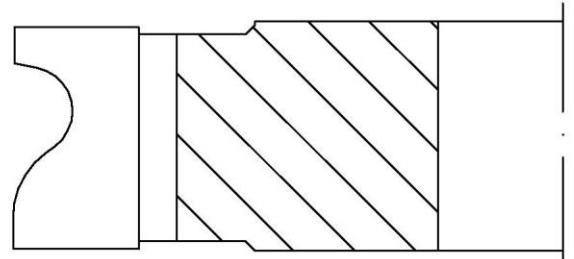
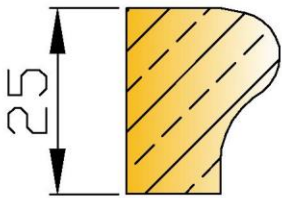

FK-317

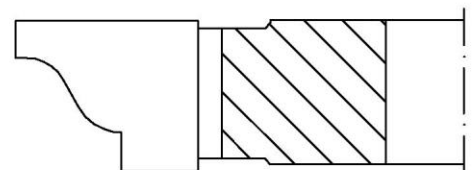
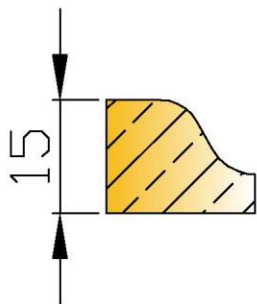

FK-318

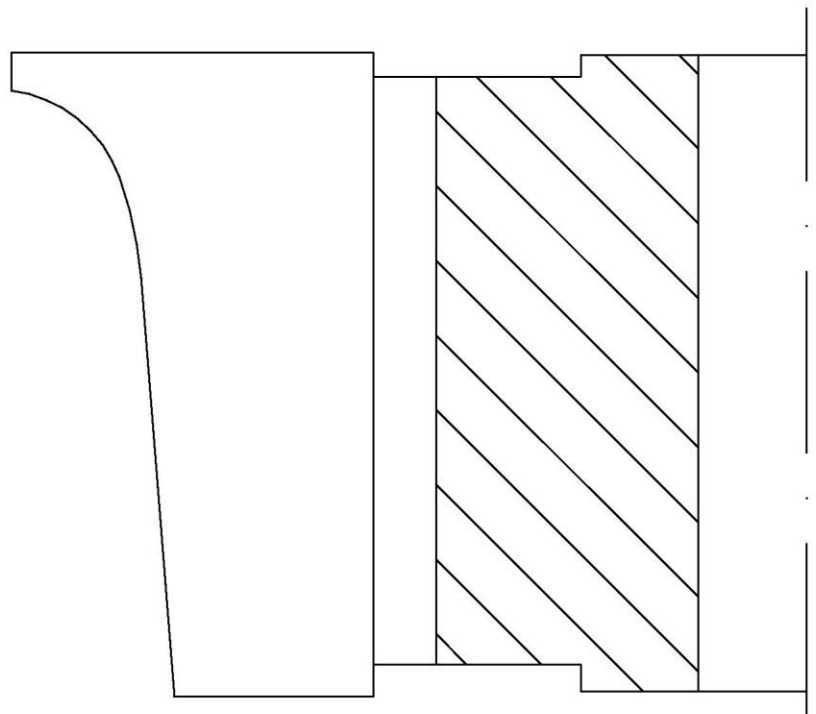
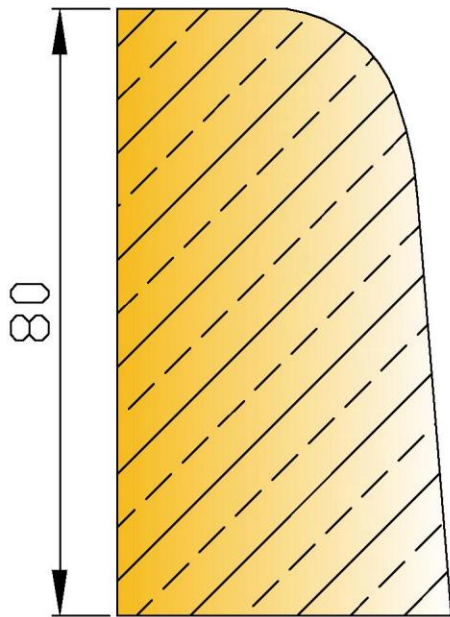

FK-319

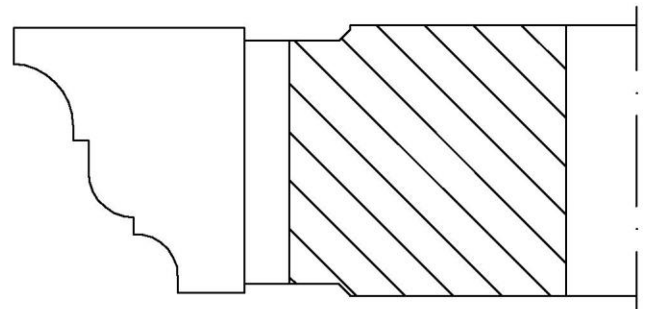
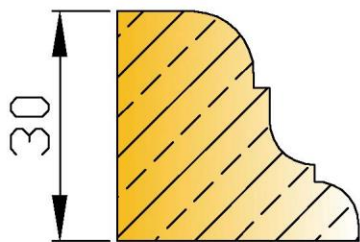

FK-320

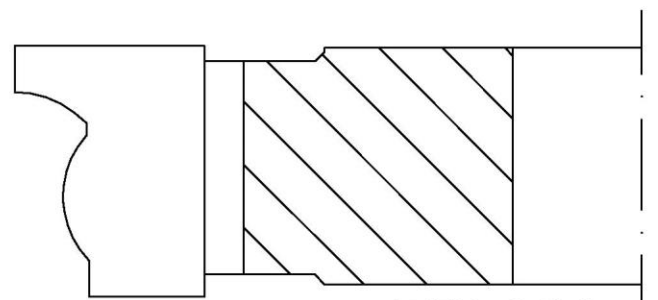
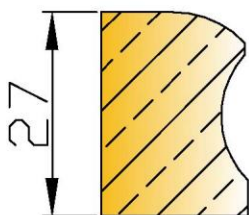

FK-321

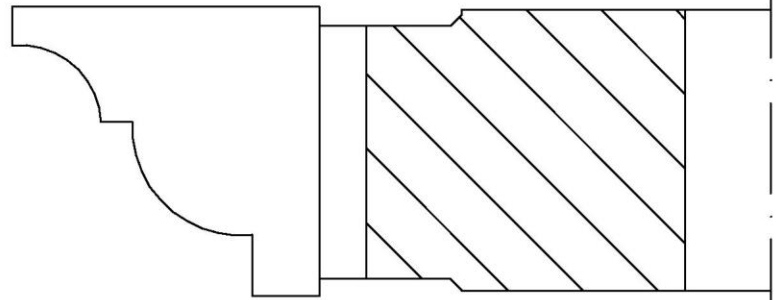
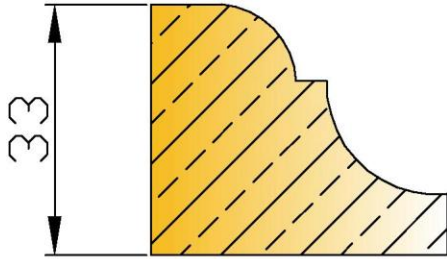

FK-322

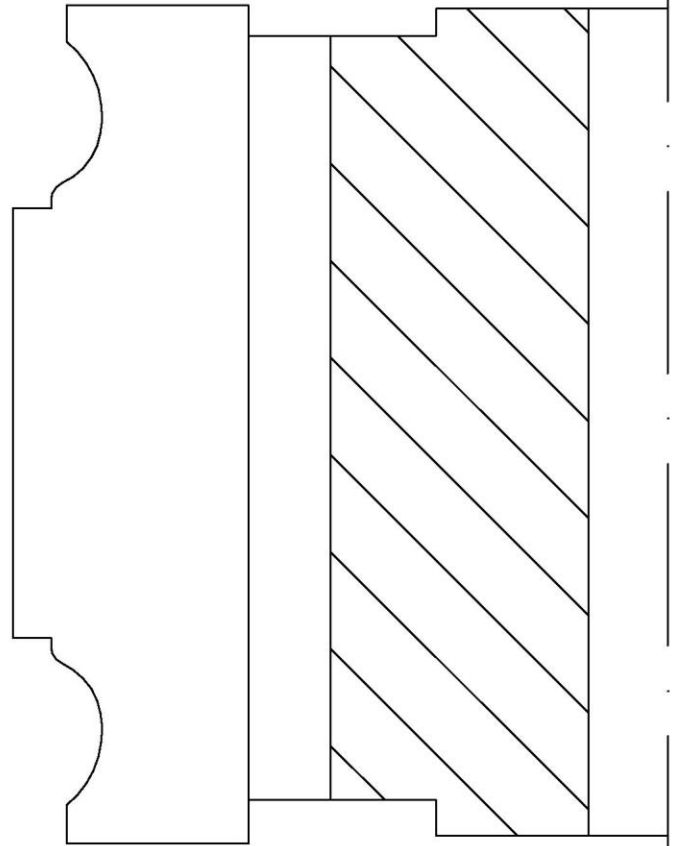
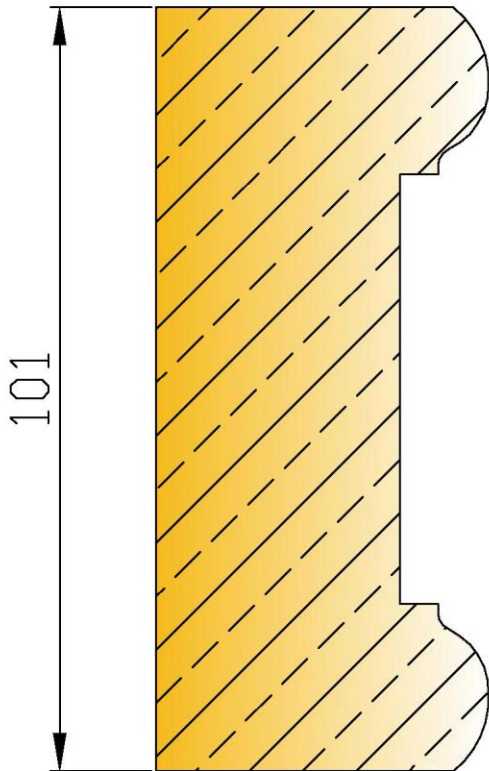

FK-323

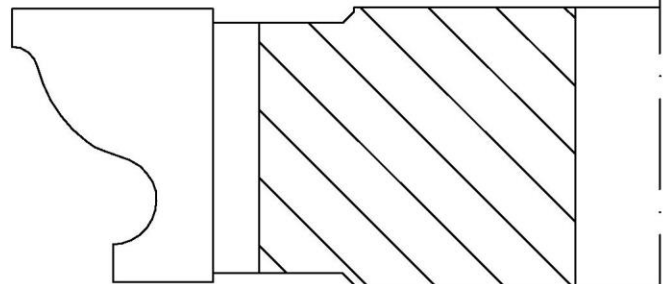
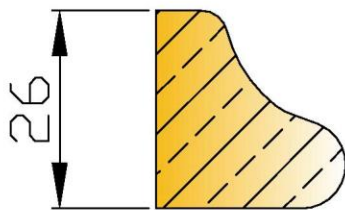

FK-324

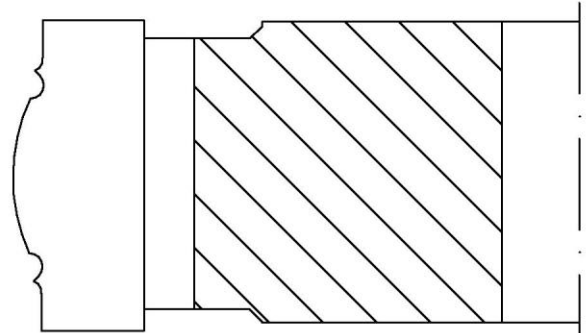
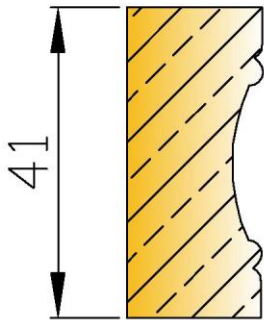

FK-325

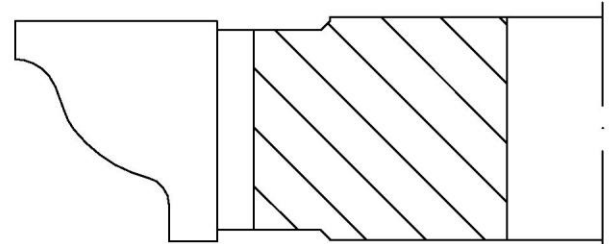
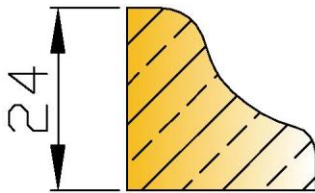

FK-326

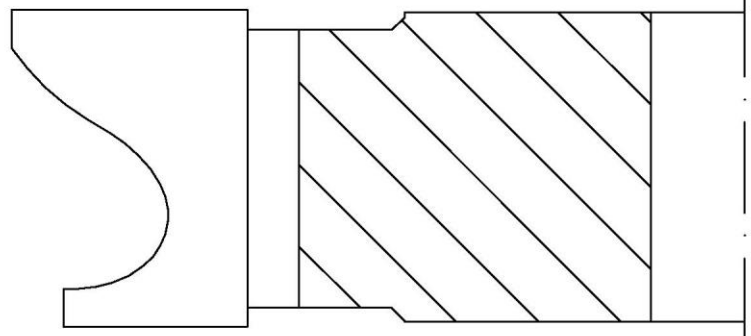
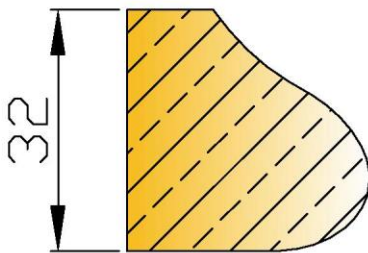

FK-327

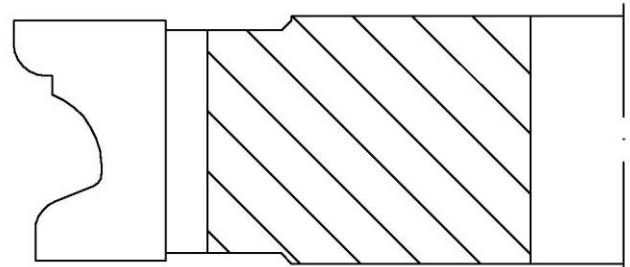
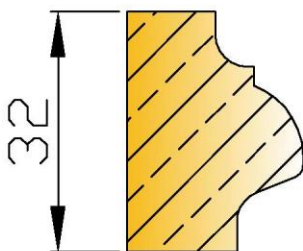

FK-328

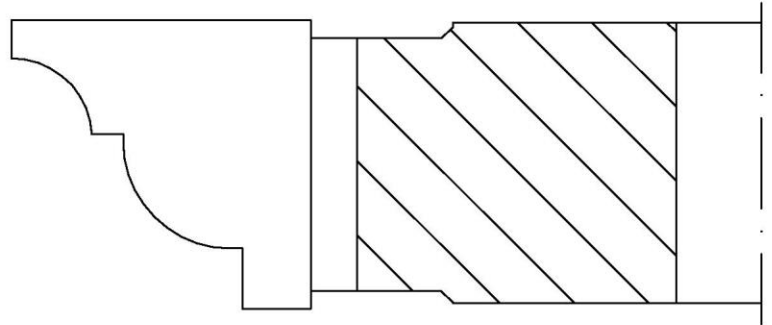
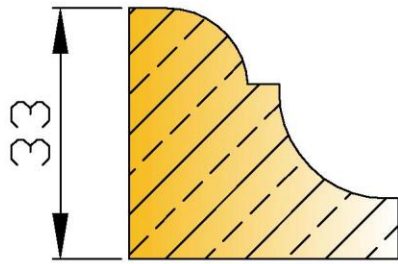

FK-329

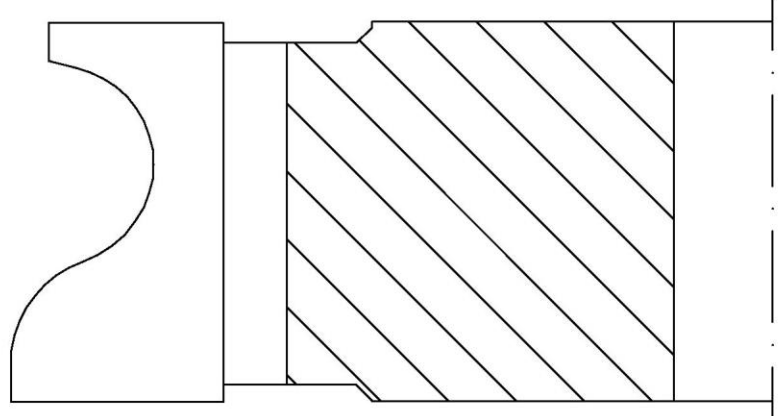
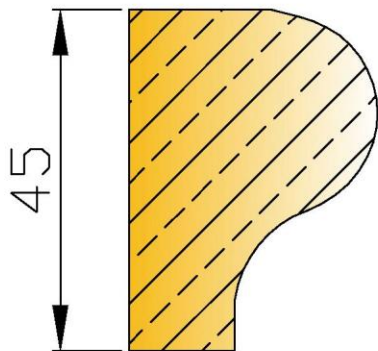

FK-330

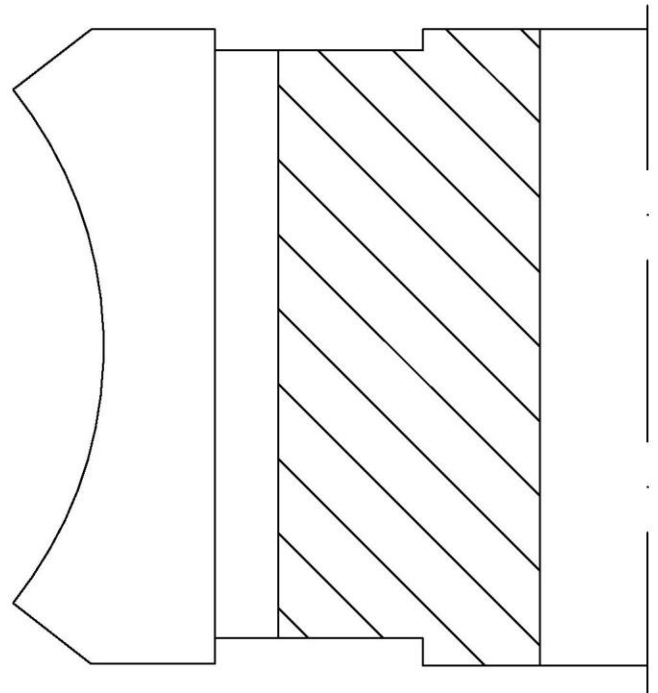
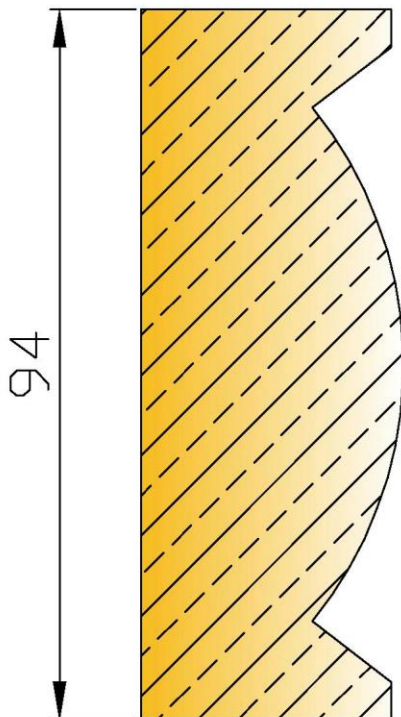

FK-331

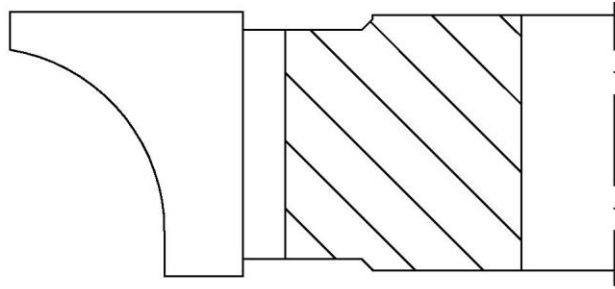
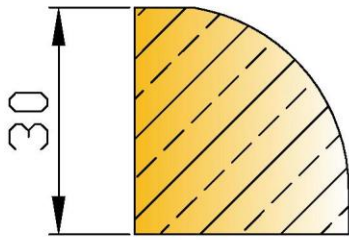
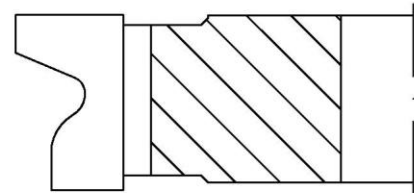
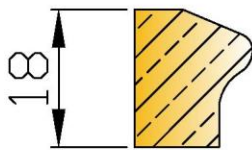
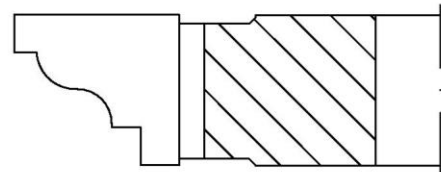
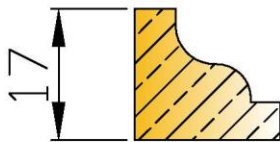
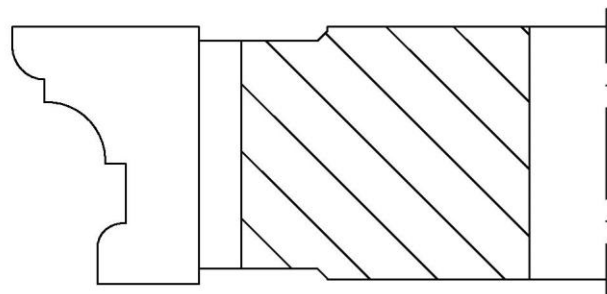
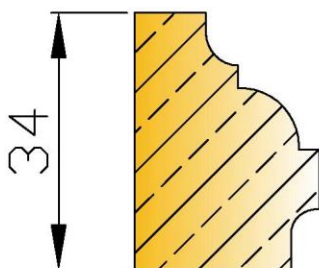
**FK-332****FK-333****FK-334****FK-335**

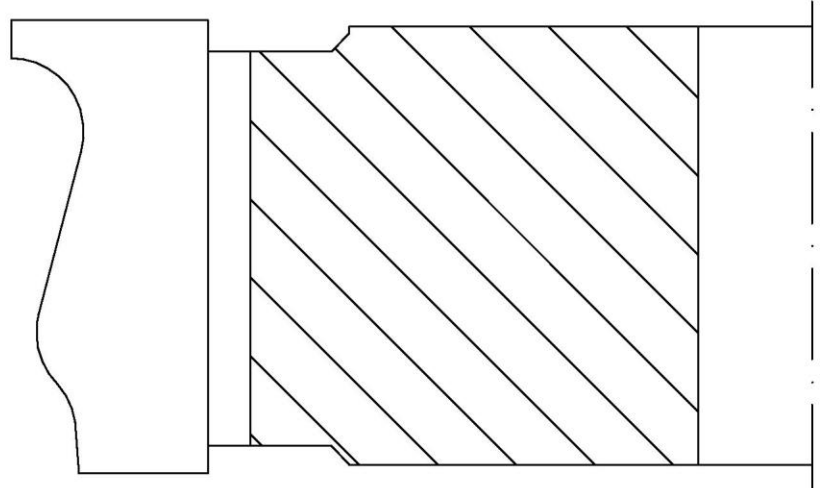
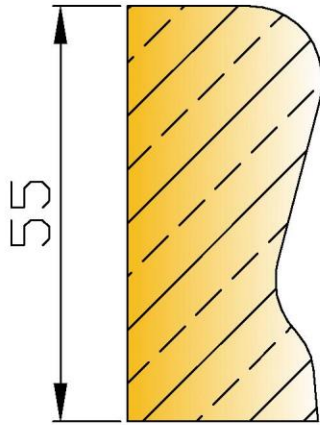

FK-336

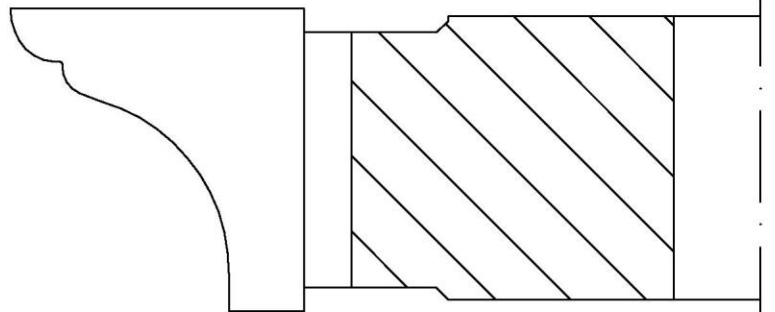
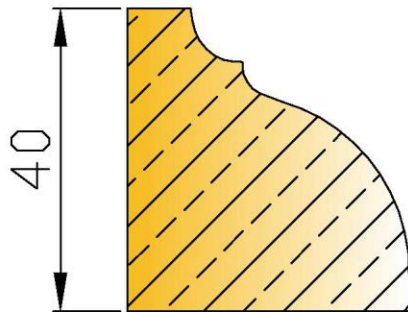

FK-337

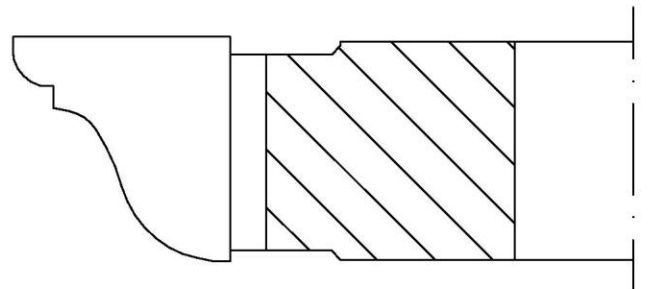
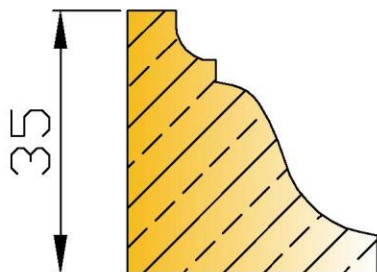

FK-338

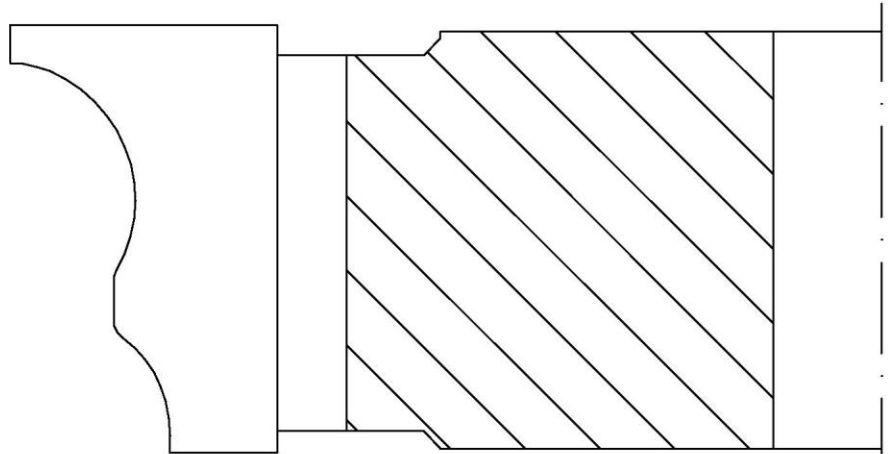
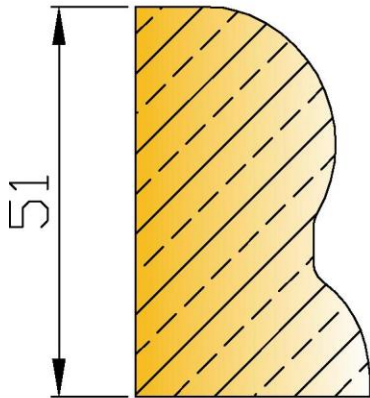

FK-339

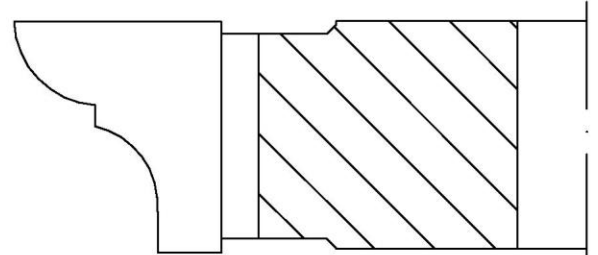
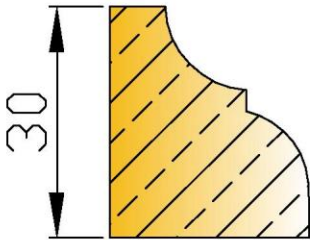

FK-340

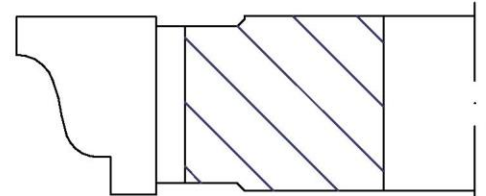
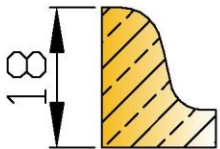

FK-341

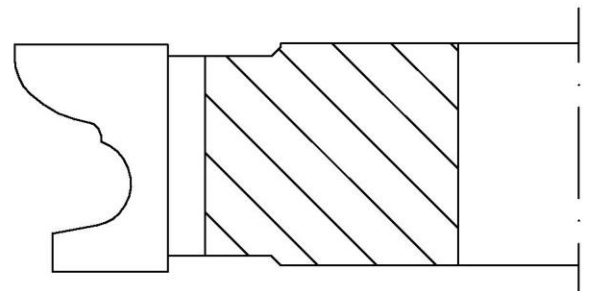
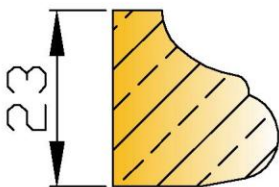

FK-342

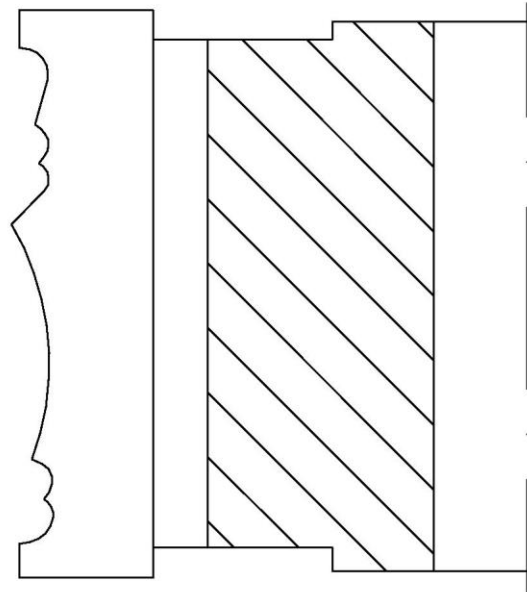
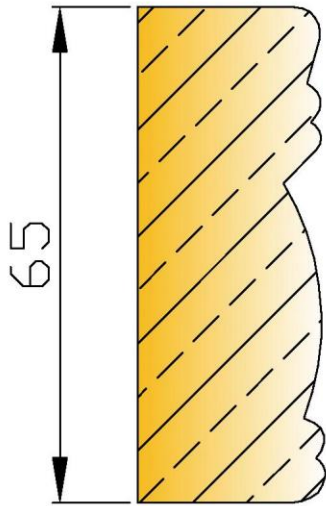

FK-343

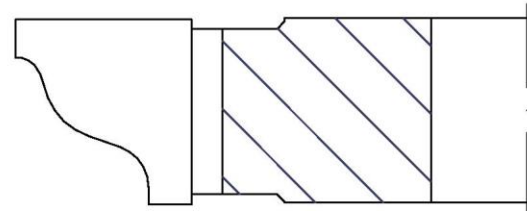
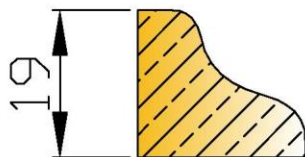

FK-344