

FREZ DO PŁYCYN DRZWIOWYCH

Adres URL: <https://mill-tech.pl/frezy-do-drewna/frez-do-plycin-drzwiowych/>

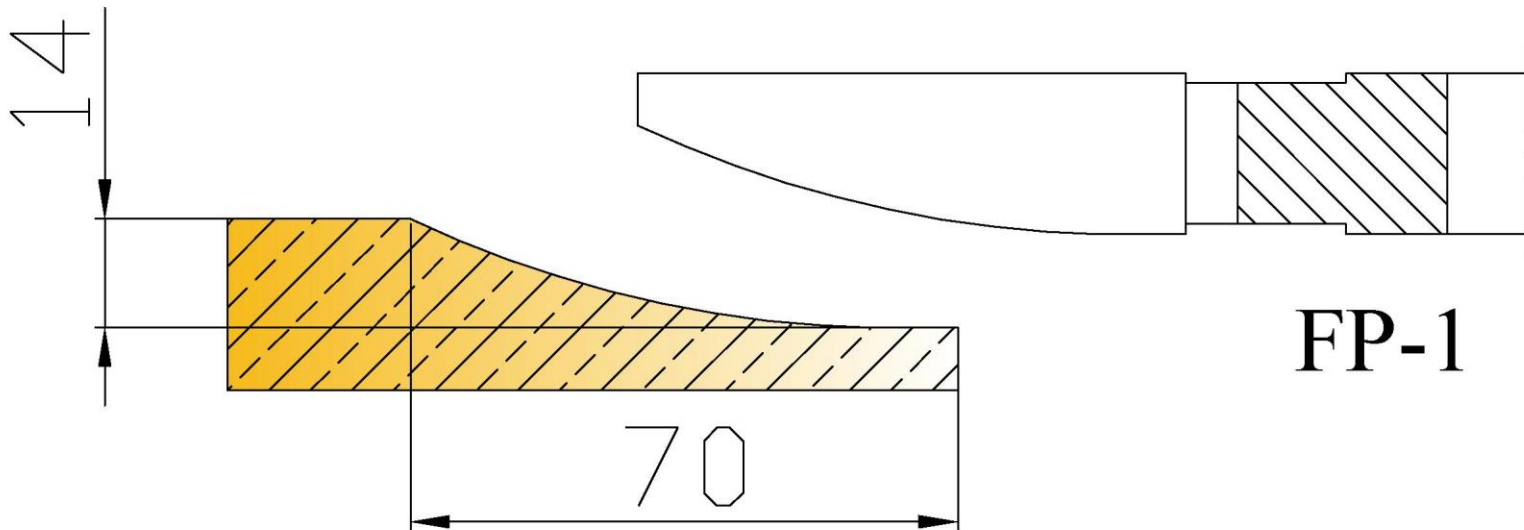

FP-1

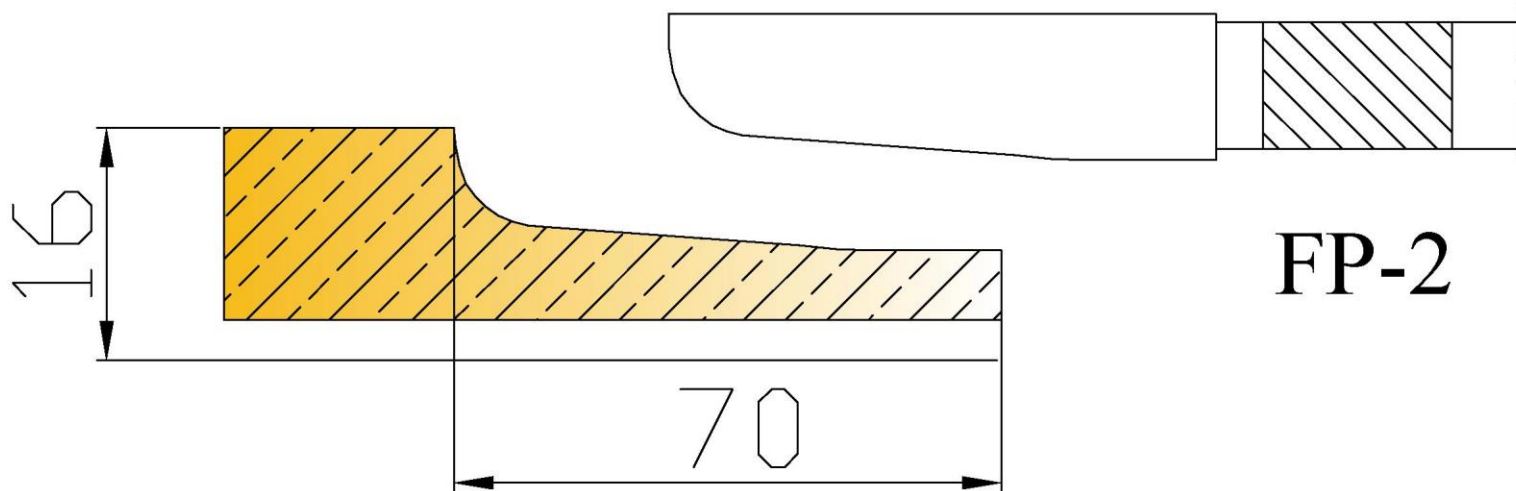

FP-2

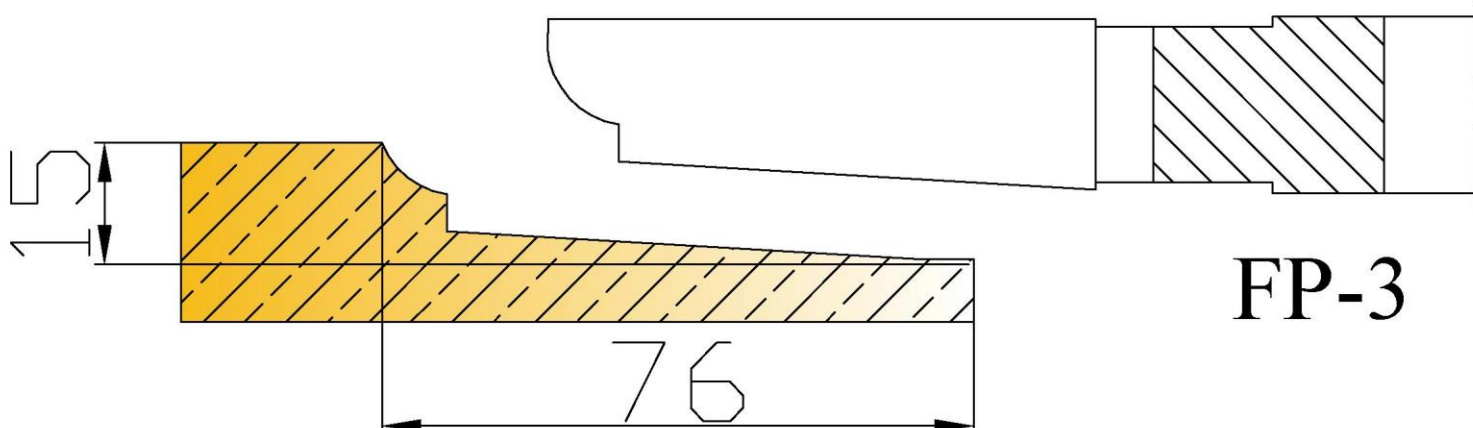

FP-3

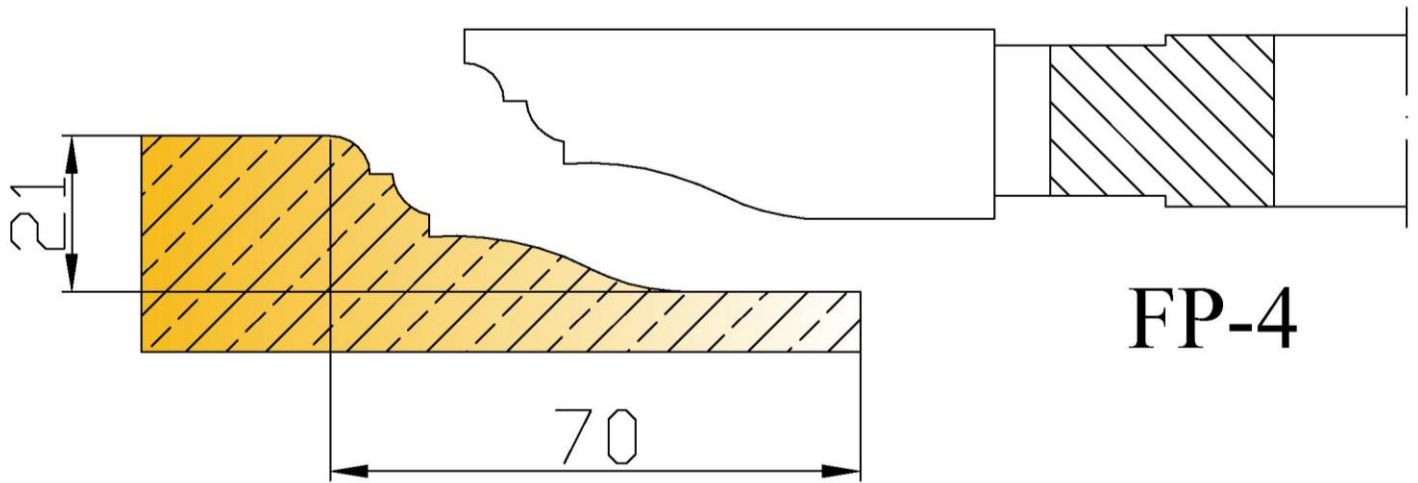
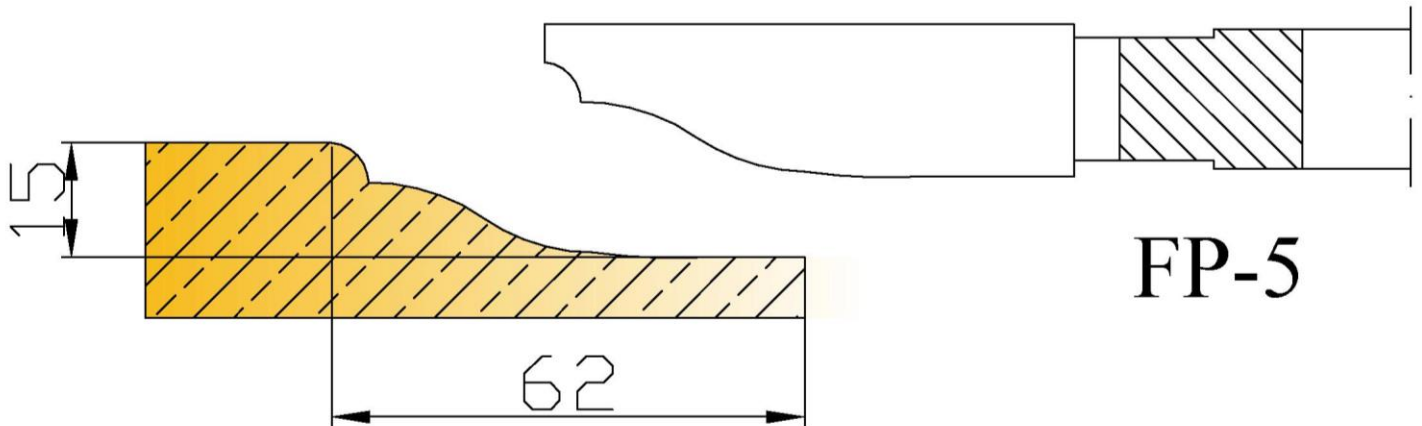
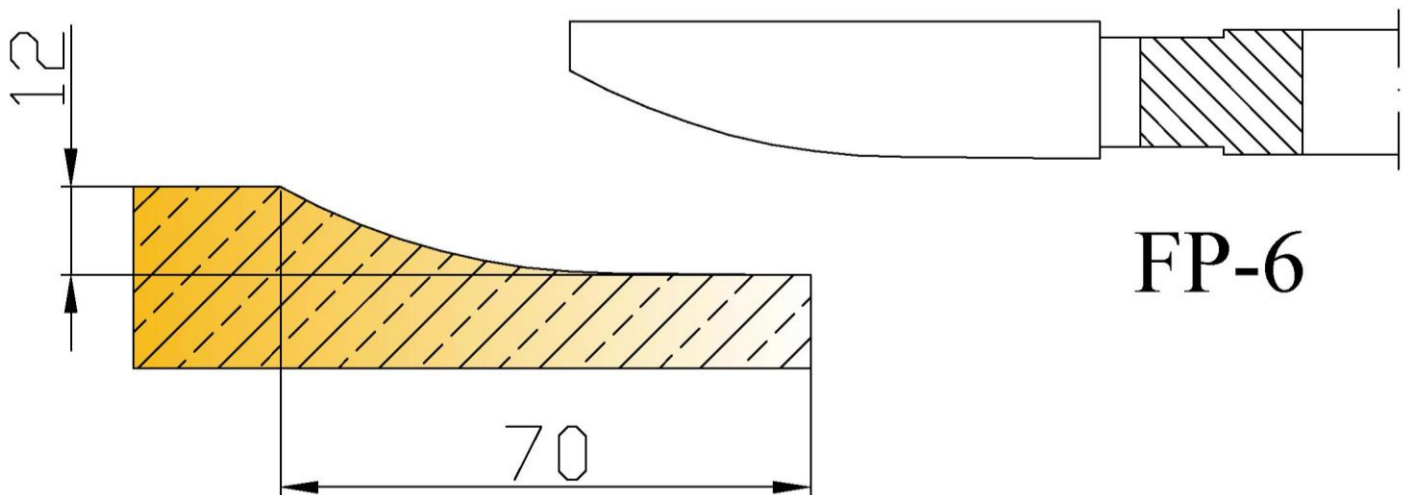
**FP-4****FP-5****FP-6**

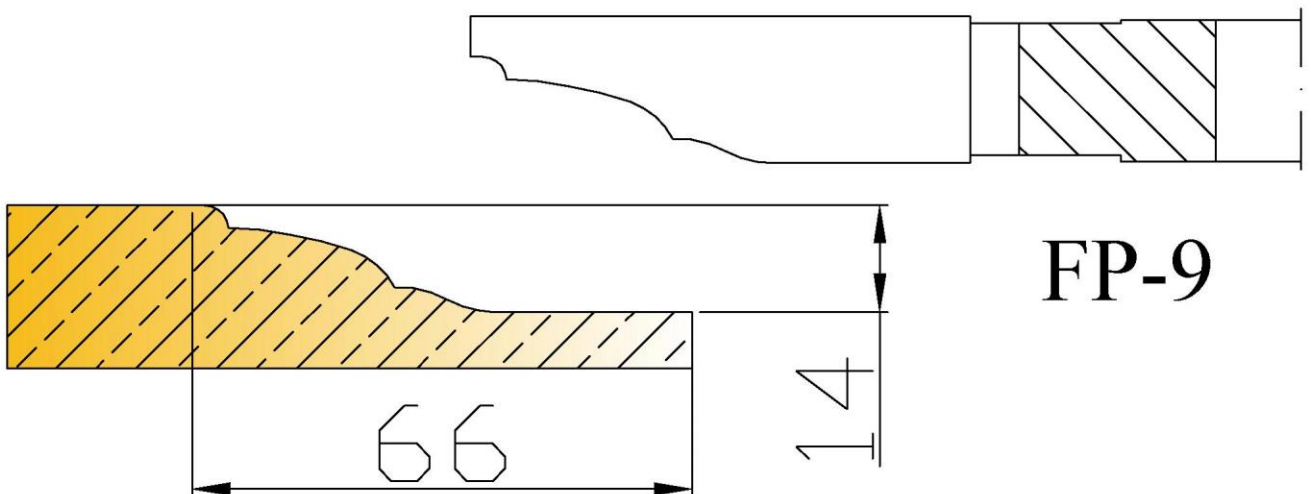
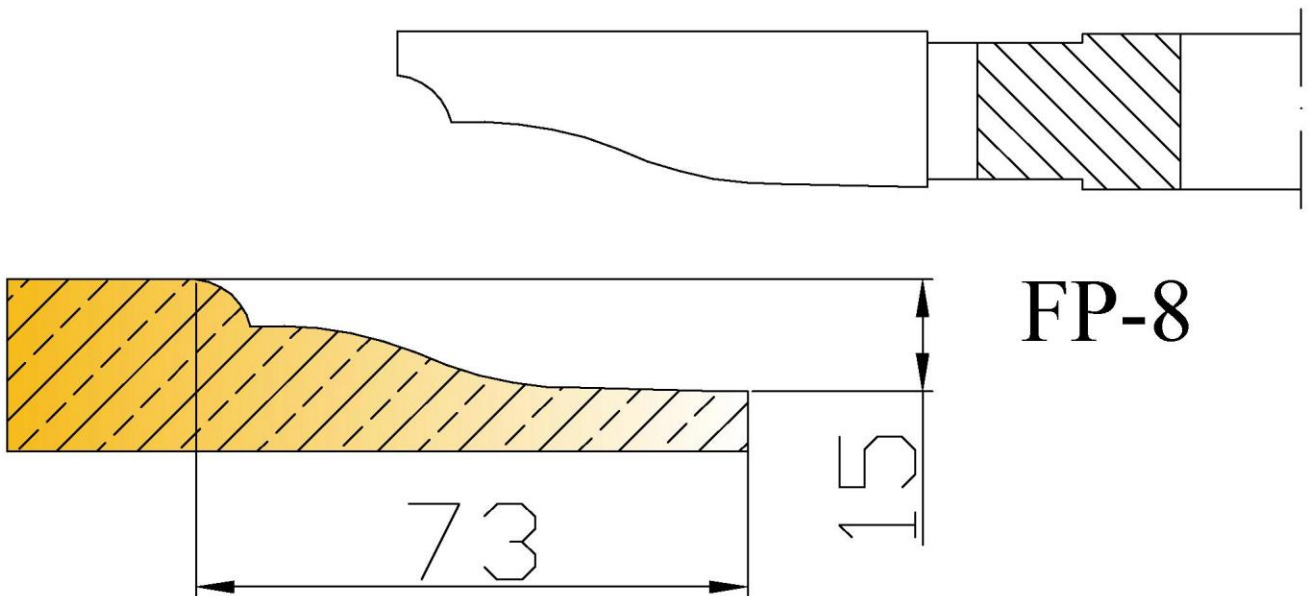
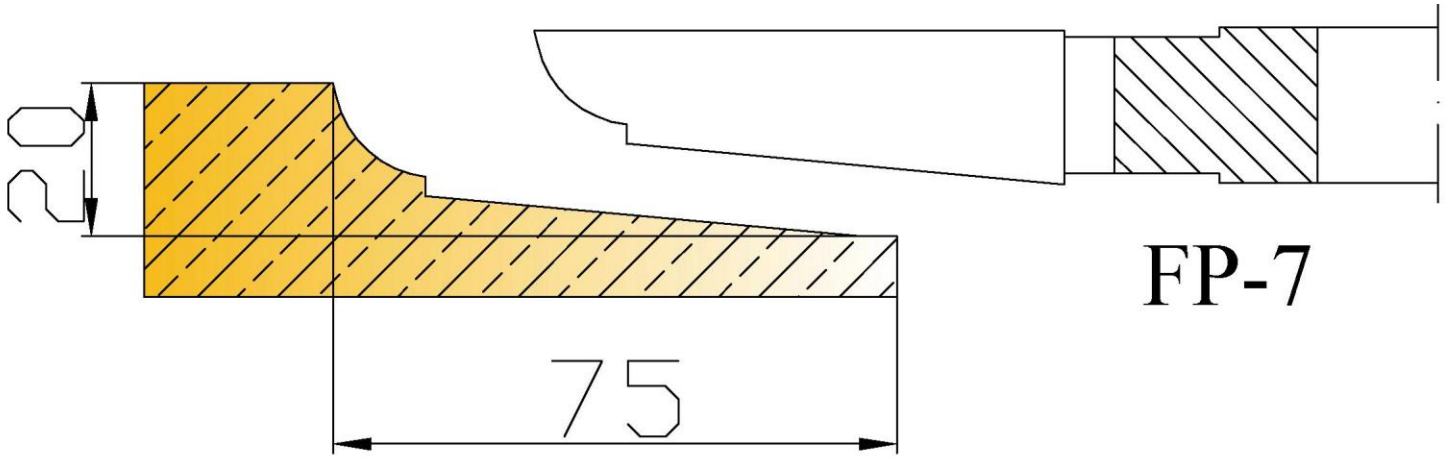

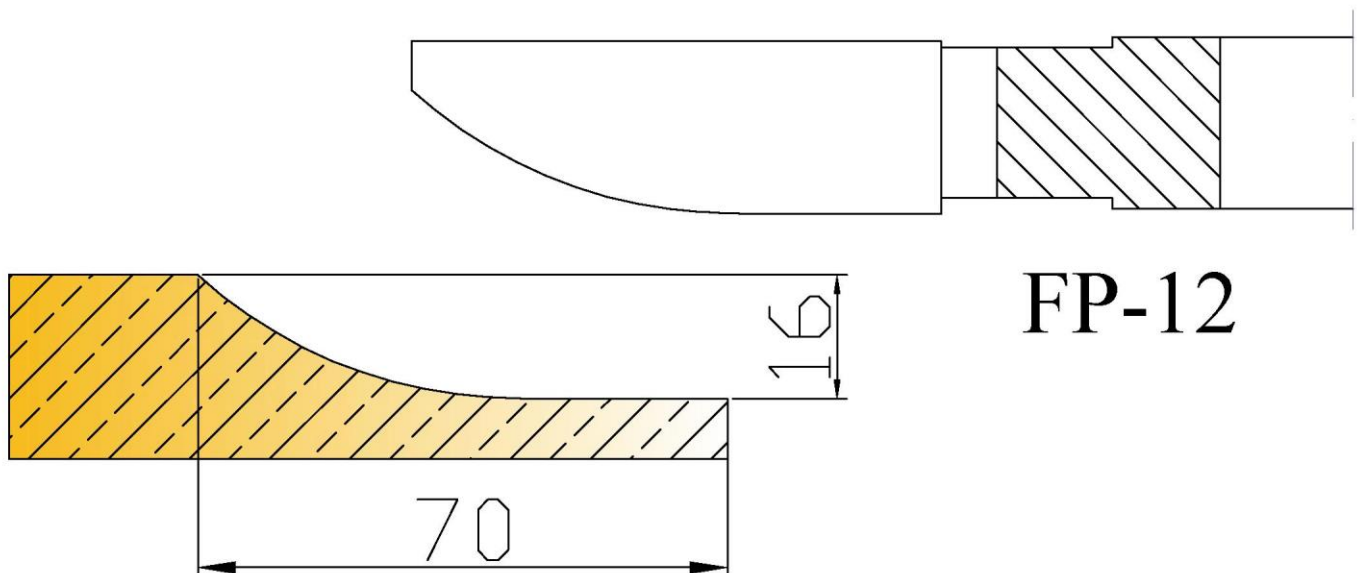
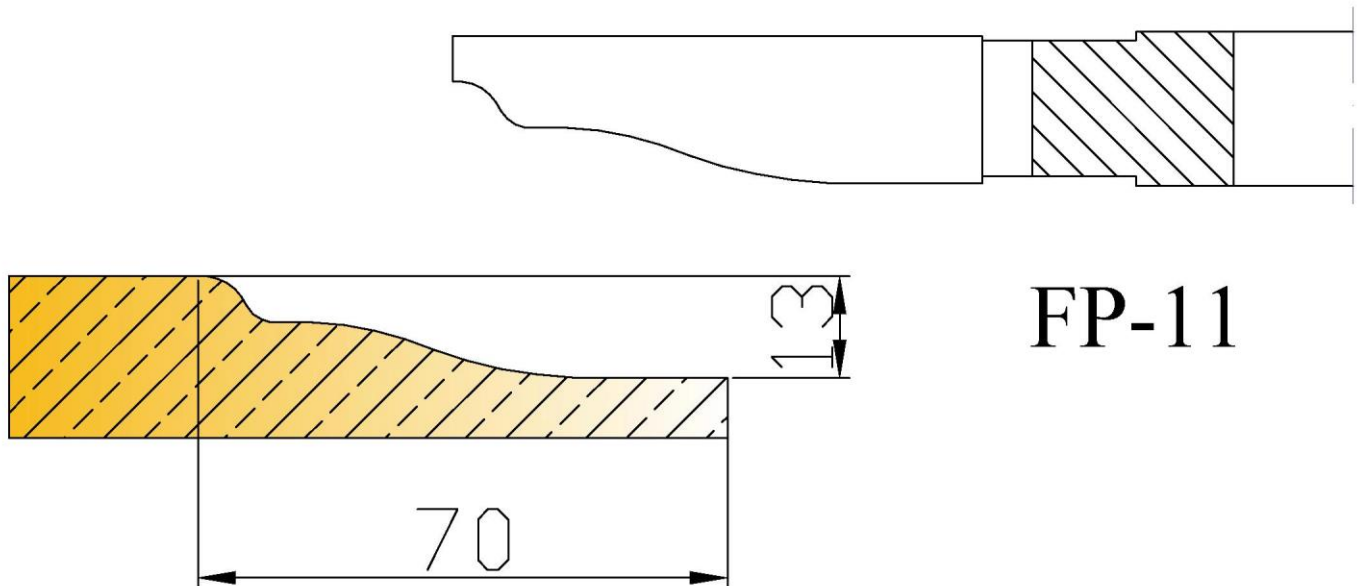
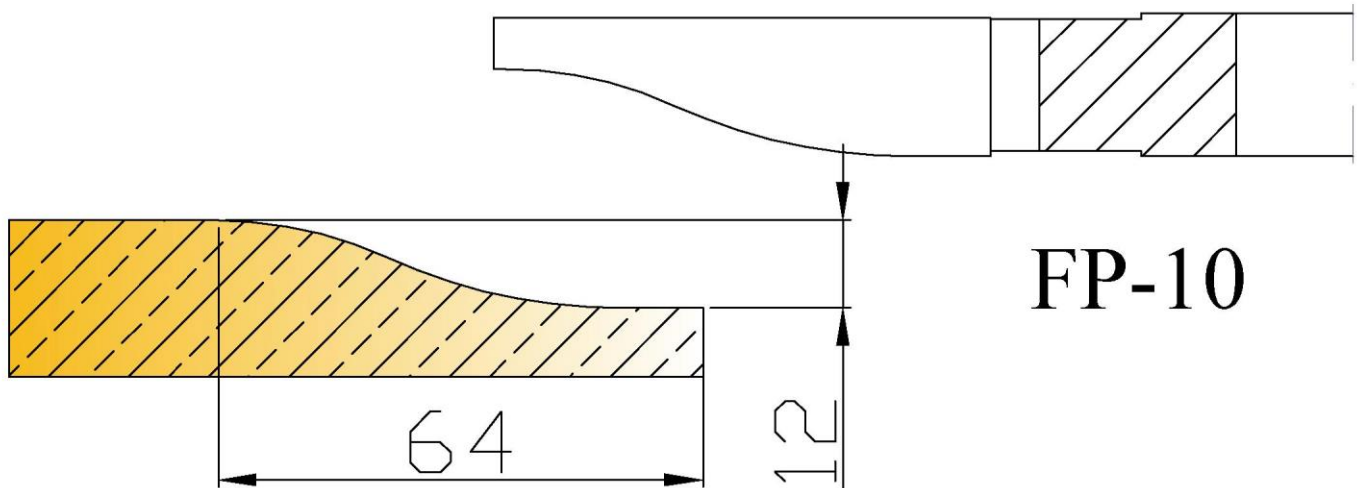

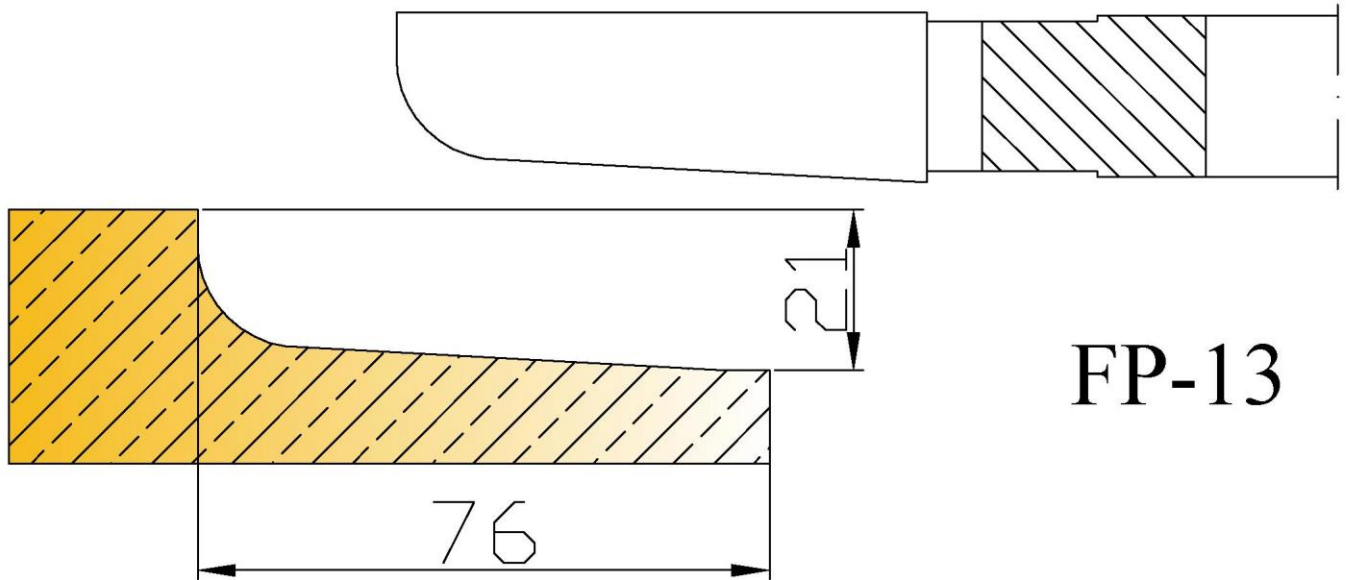
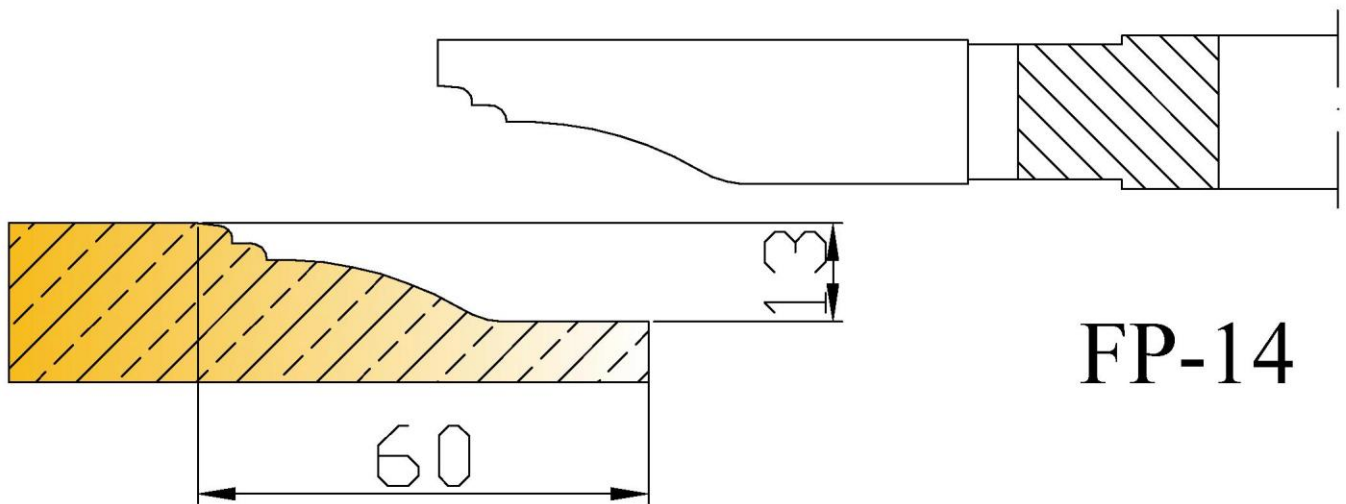
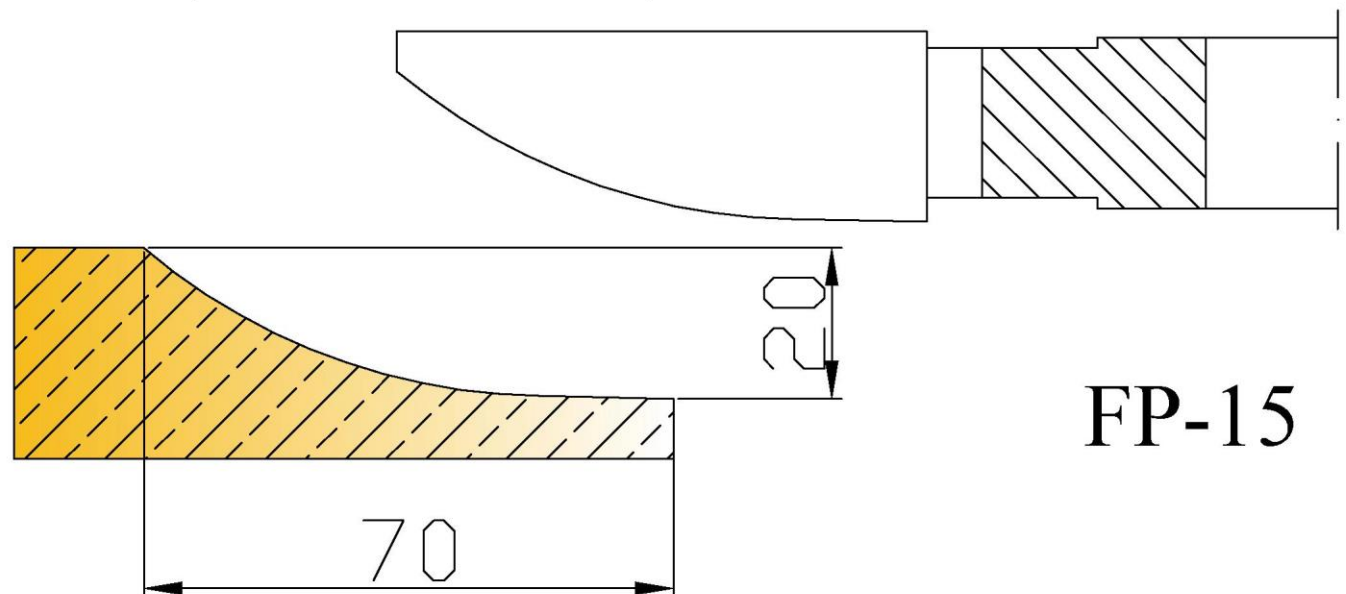
**FP-13****FP-14****FP-15**

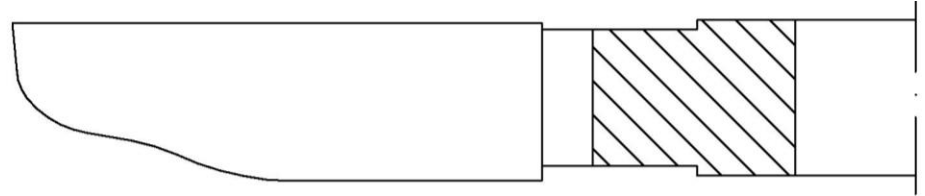
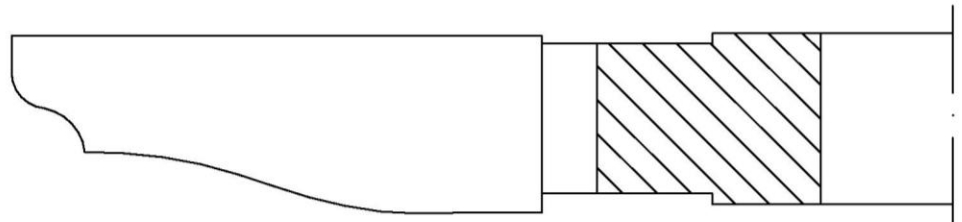
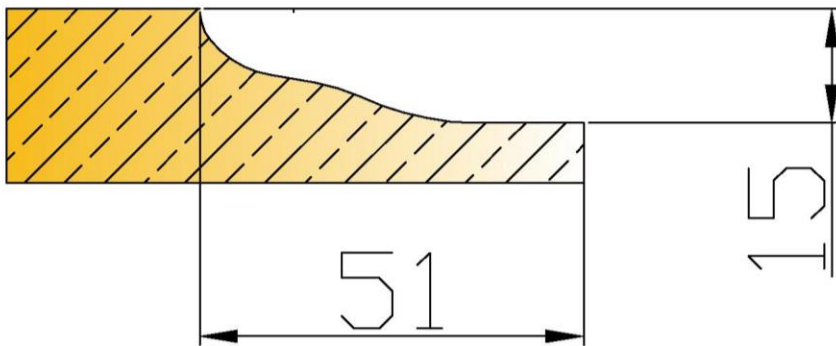
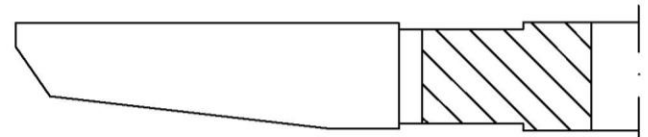
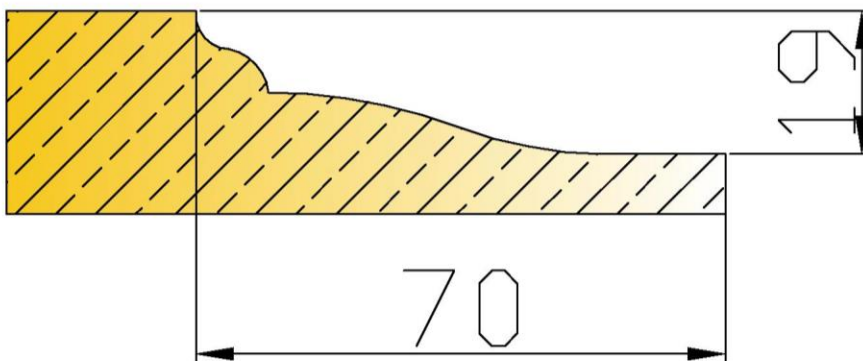
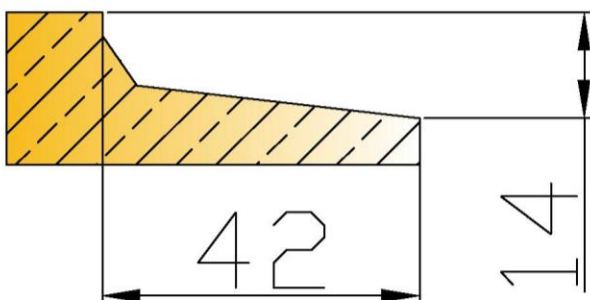
**FP-16****FP-17****FP-18**

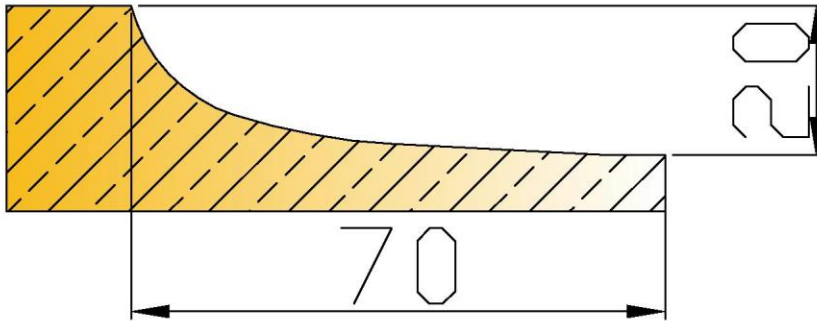
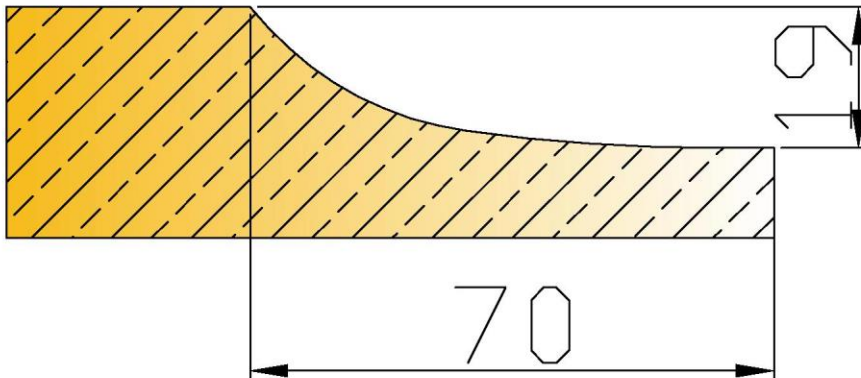
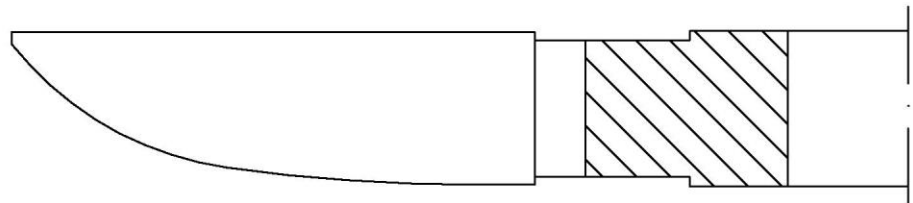
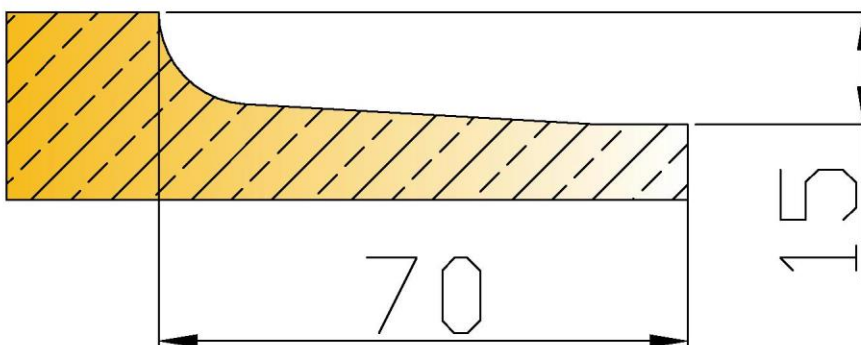
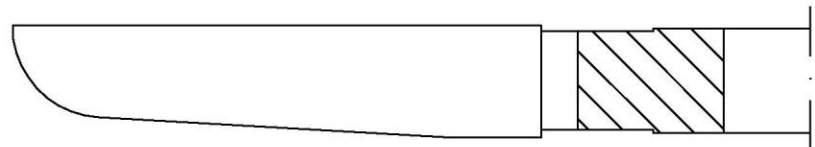
**FP-19****FP-20****FP-21**

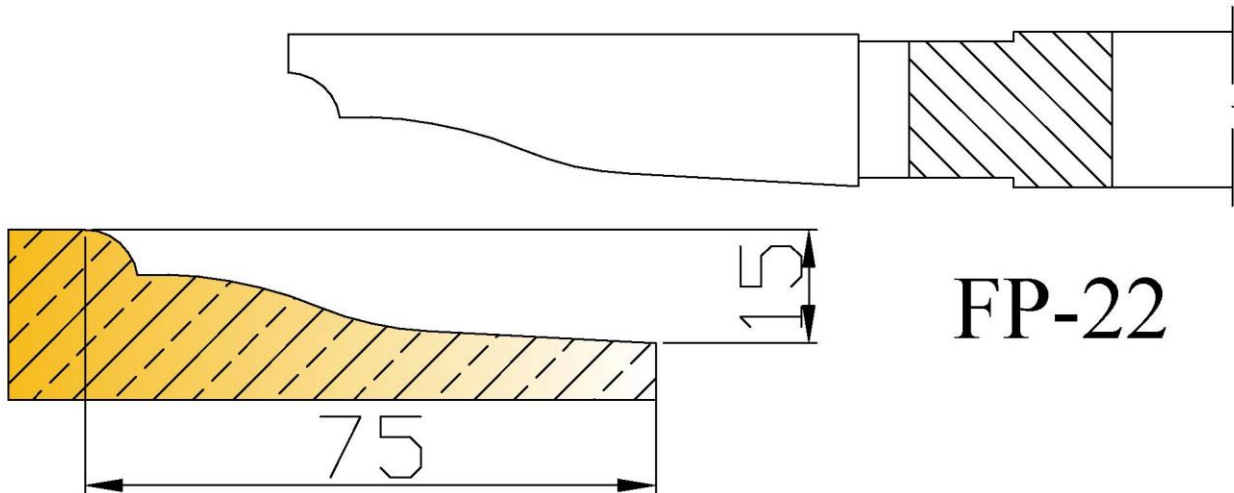
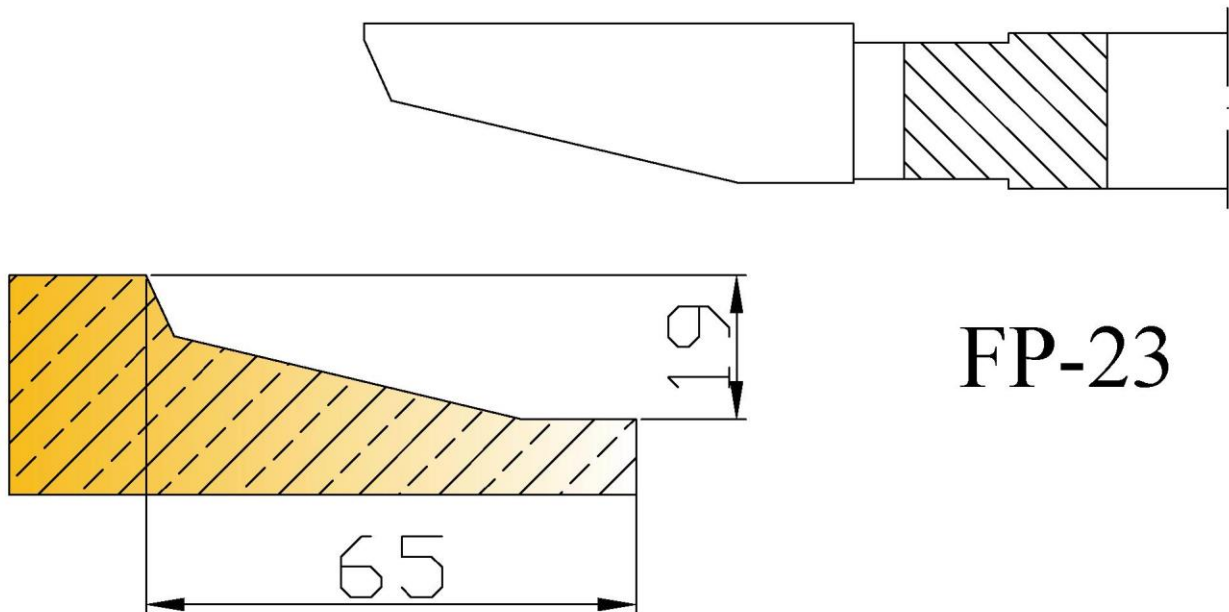
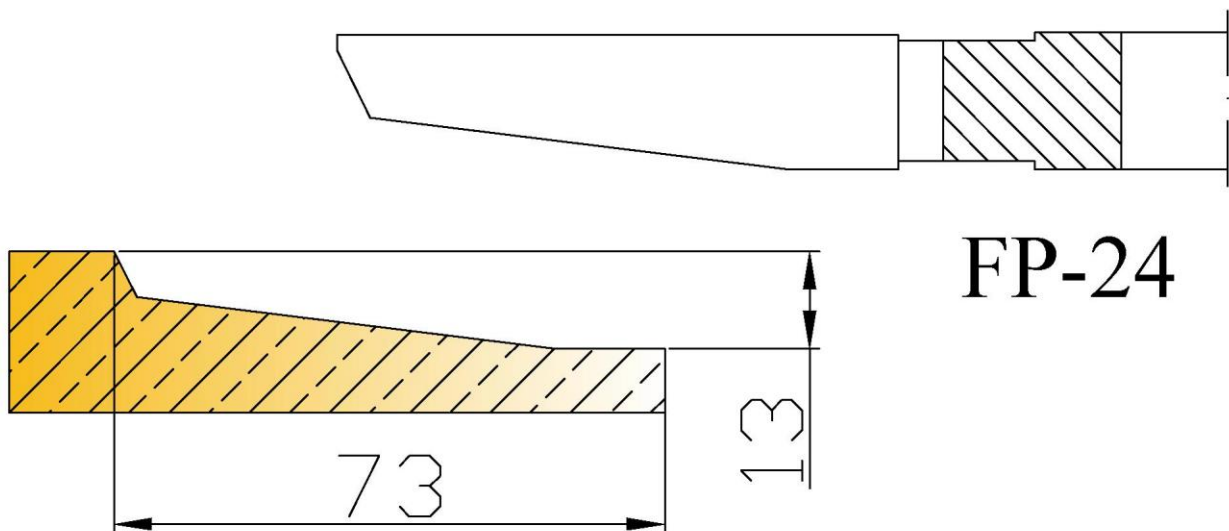
**FP-22****FP-23****FP-24**

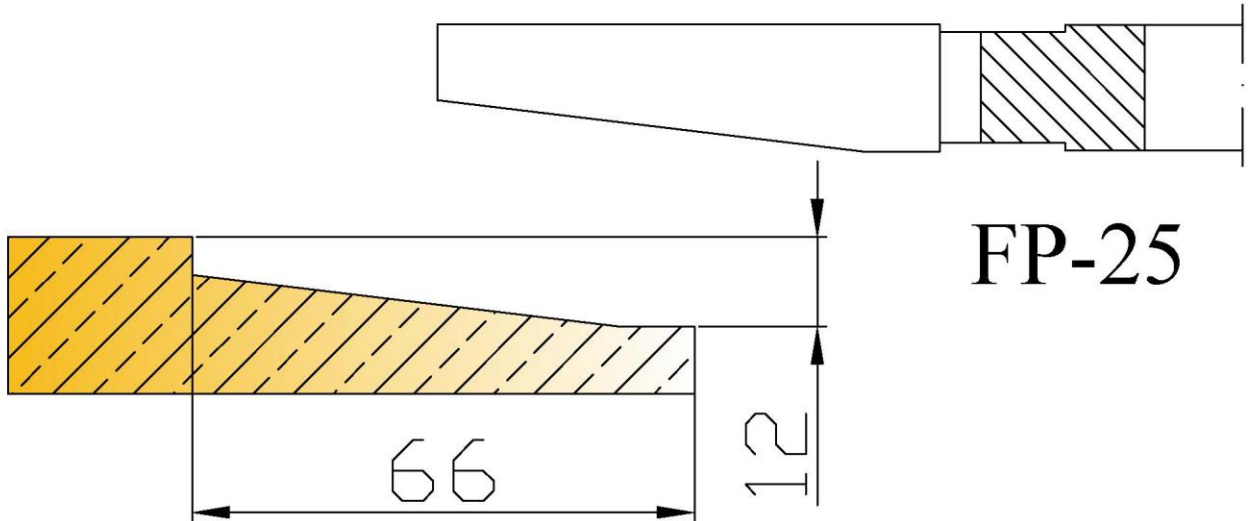
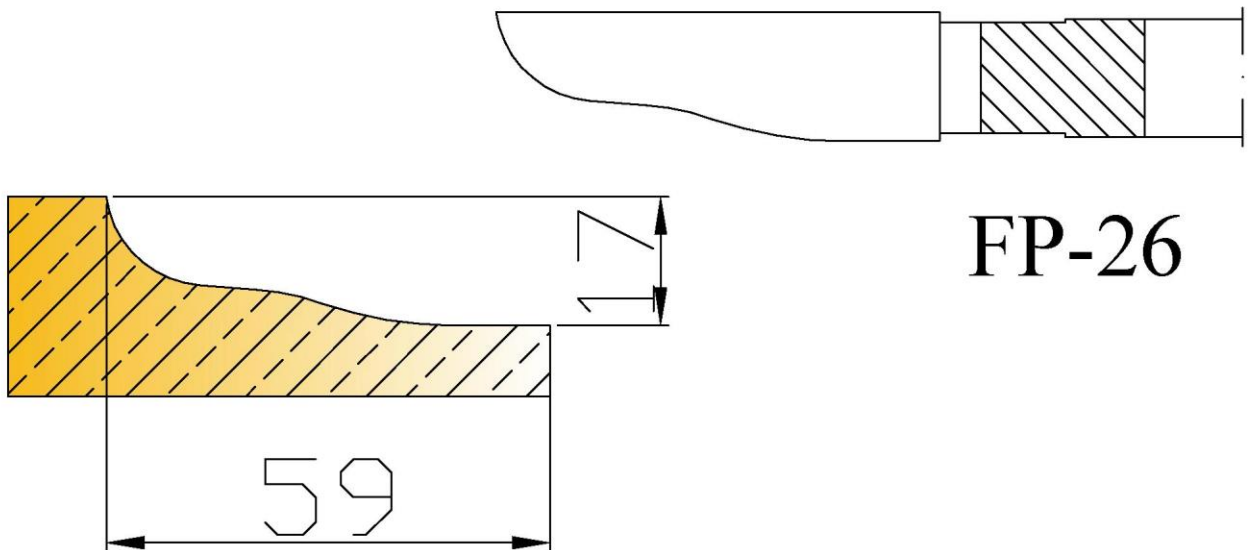
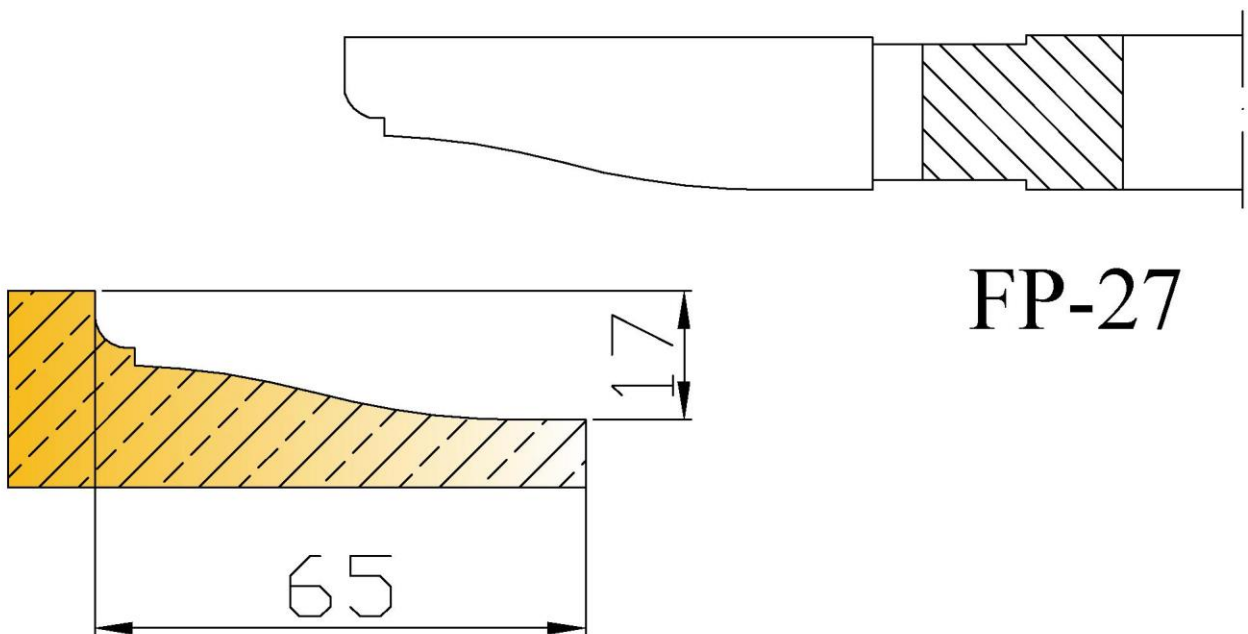
**FP-25****FP-26****FP-27**

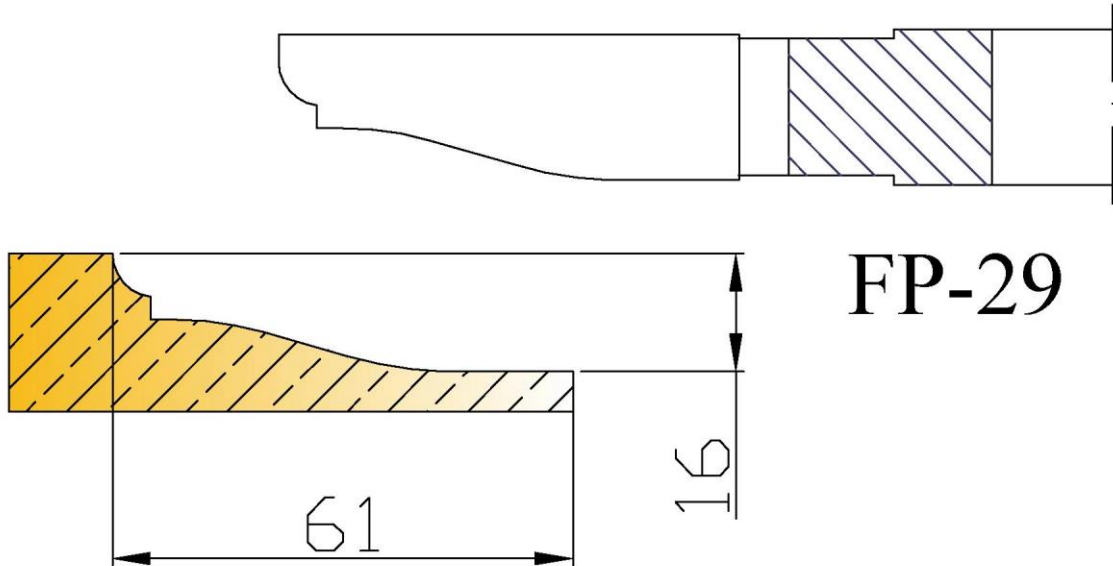
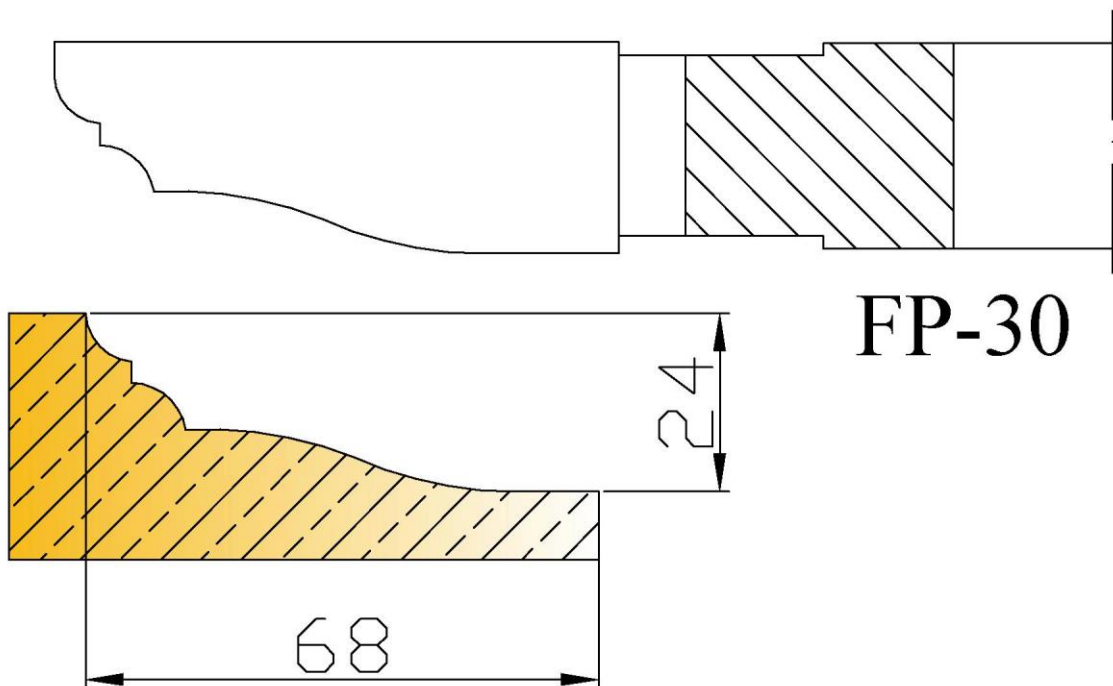
**FP-28****FP-29****FP-30**

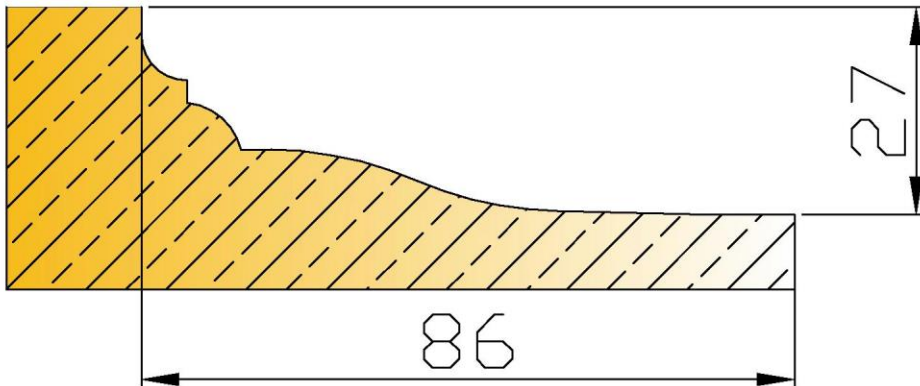
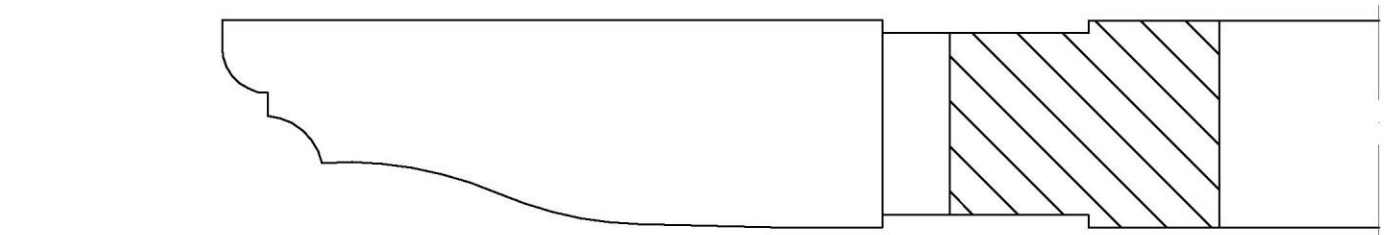
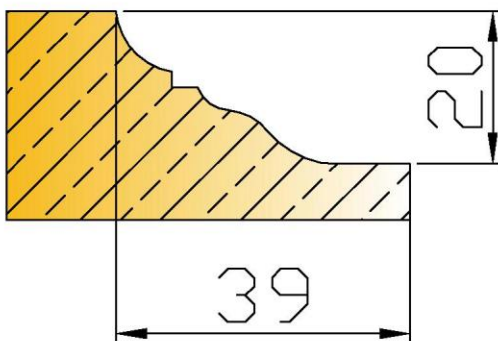
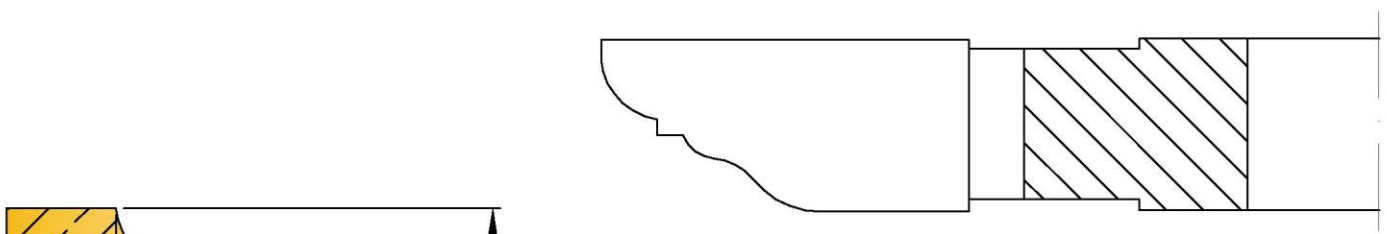
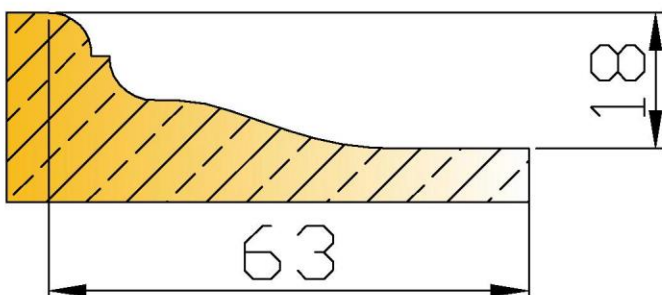
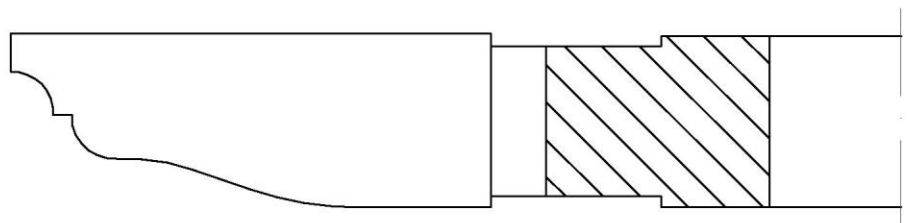
**FP-31****FP-32****FP-33**

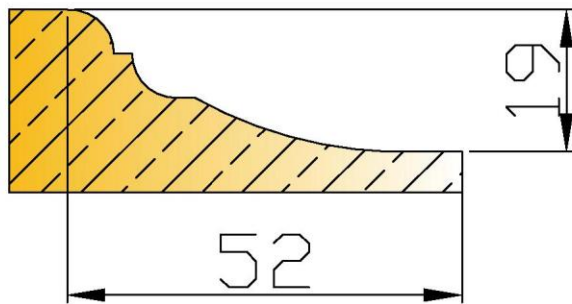
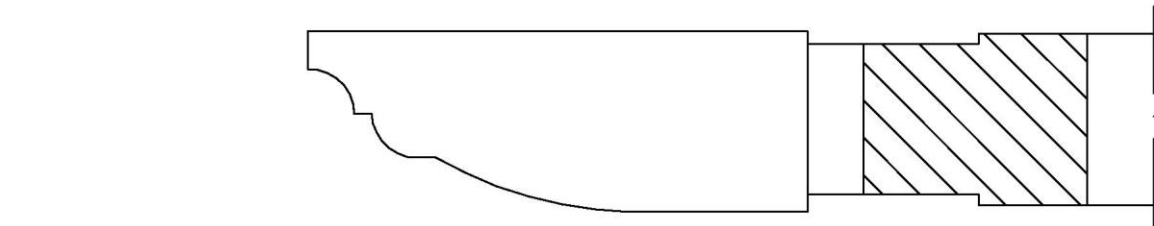
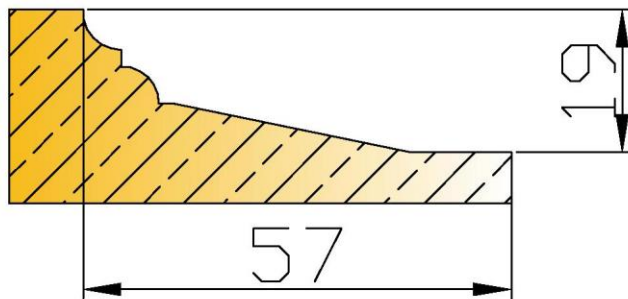
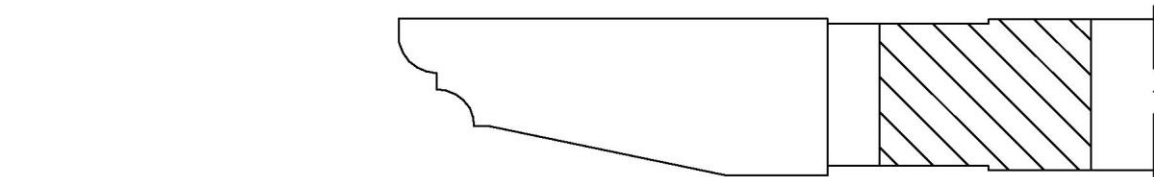
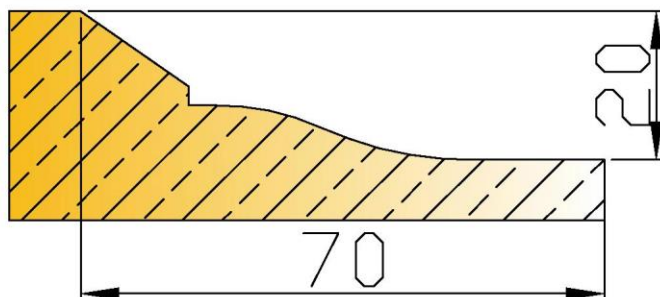
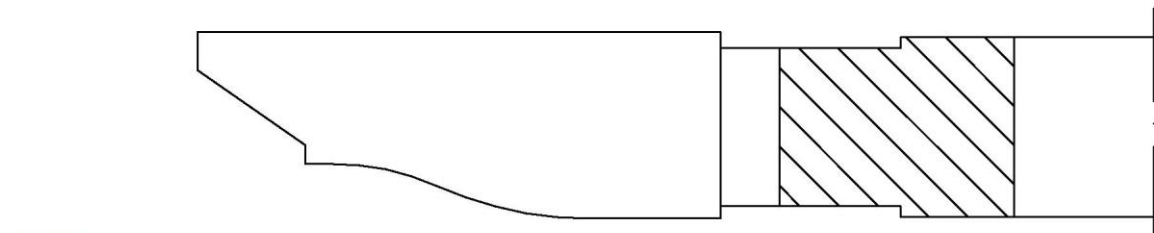
**FP-34****FP-35****FP-36**

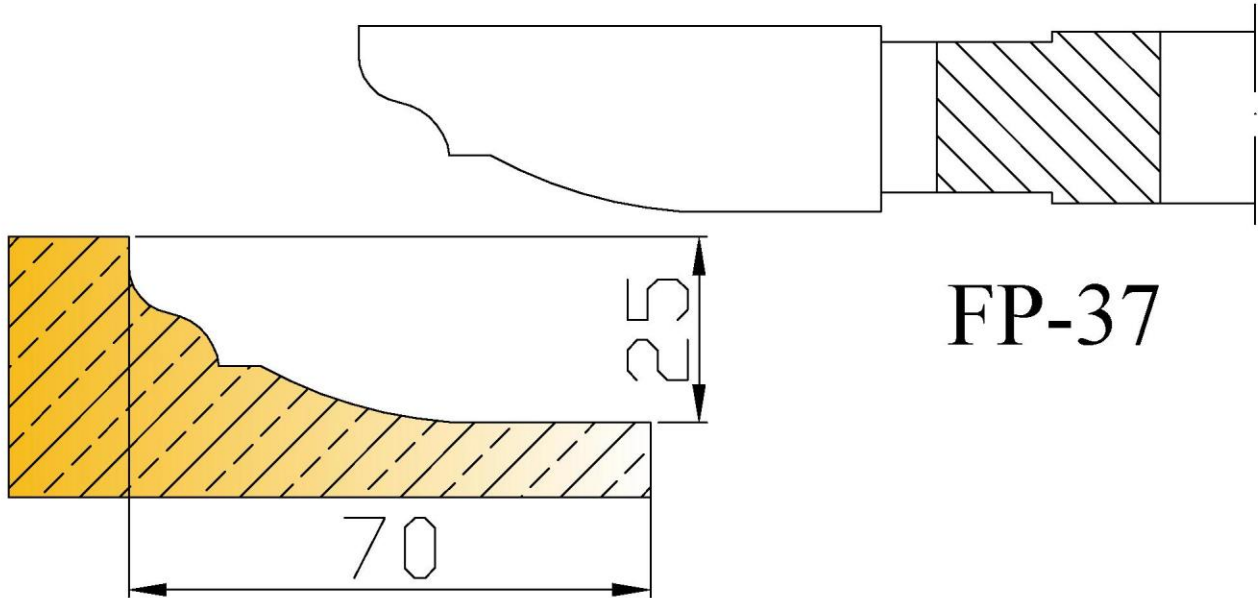
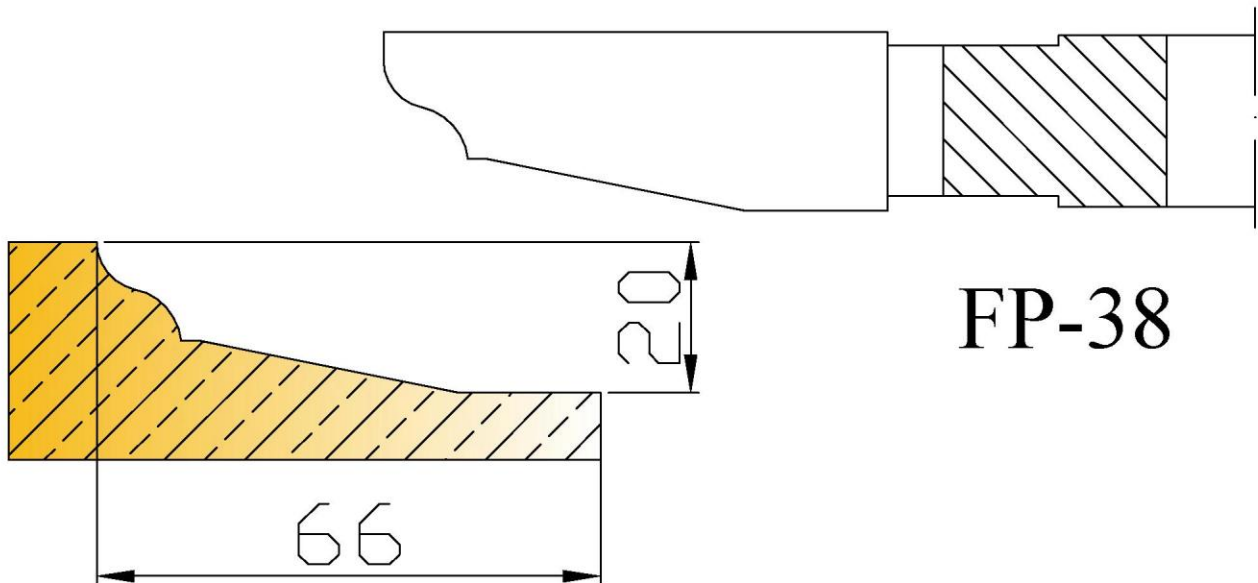
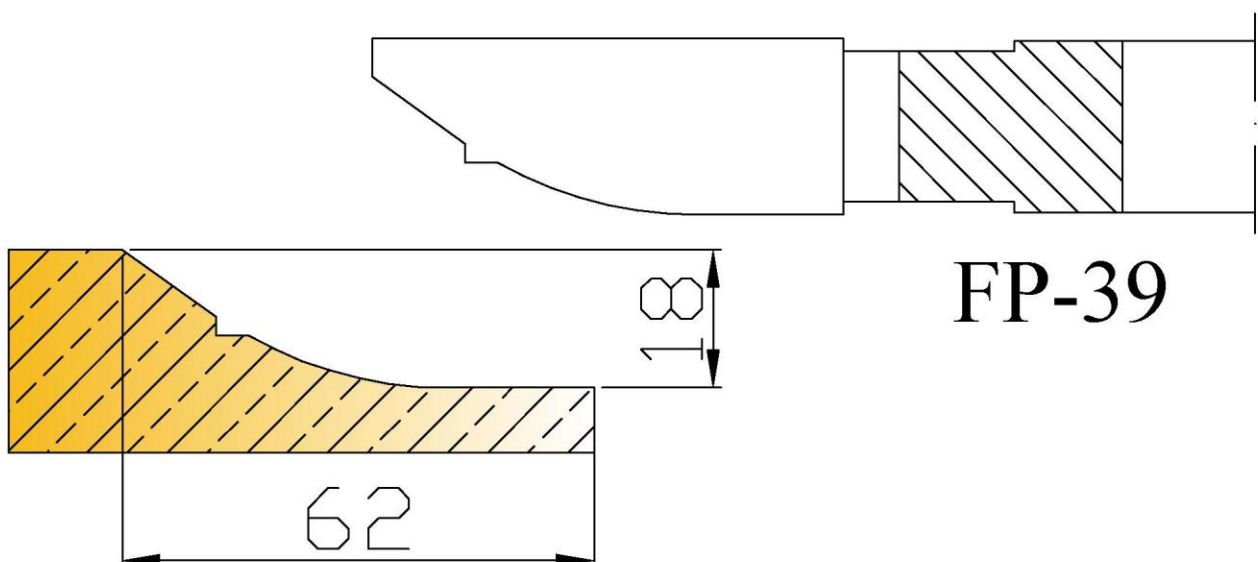
**FP-37****FP-38****FP-39**

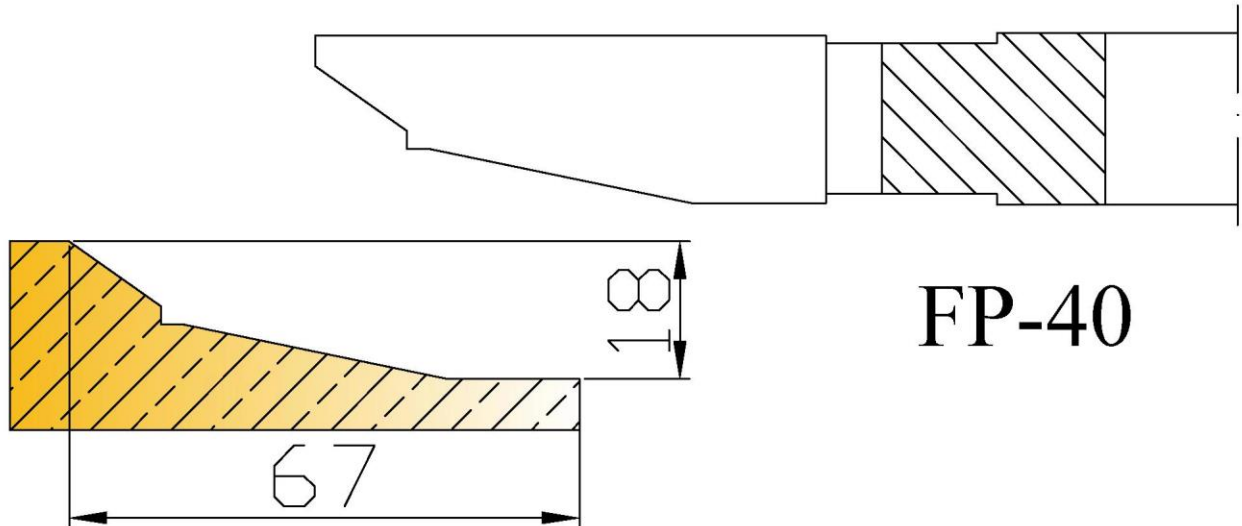
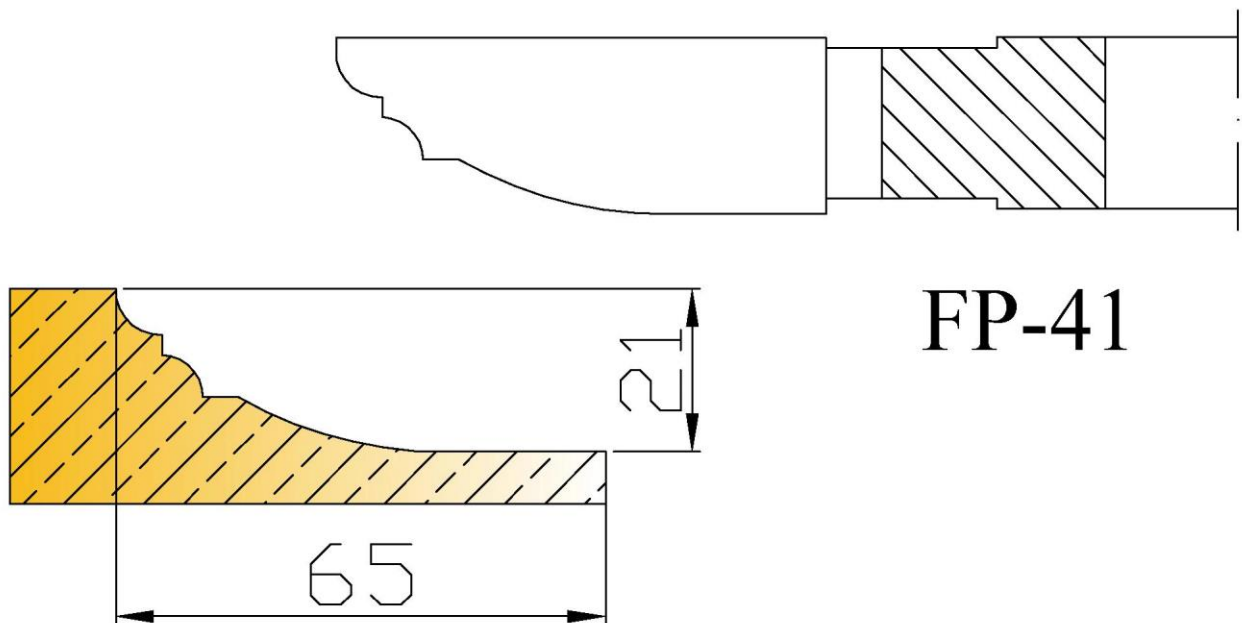
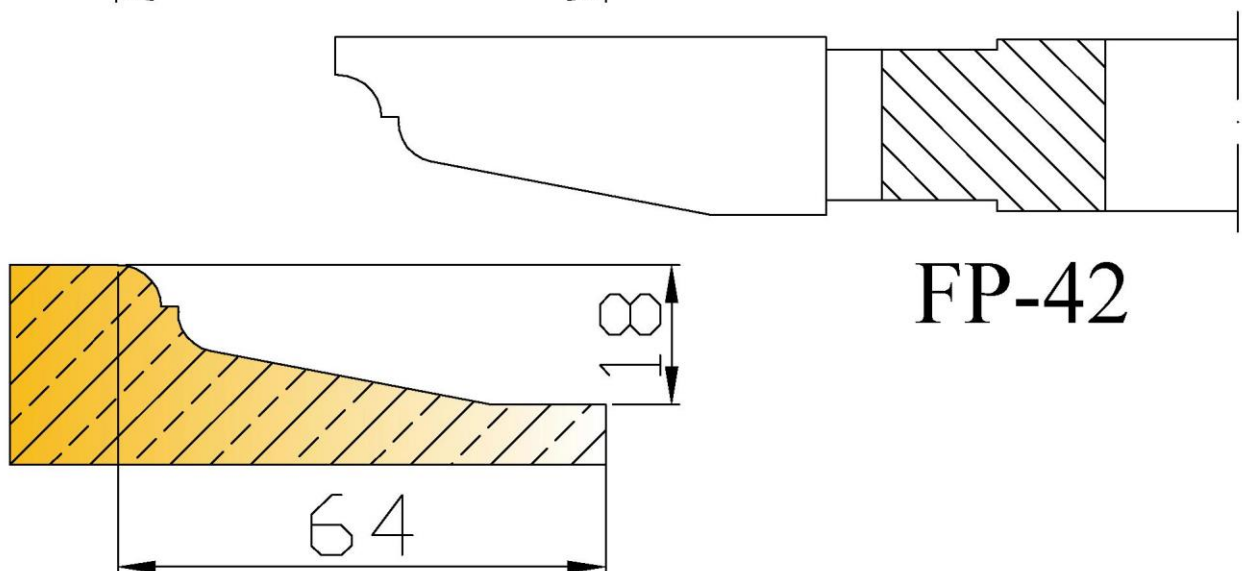
**FP-40****FP-41****FP-42**

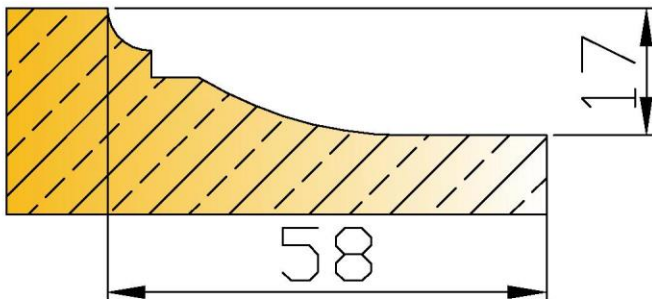
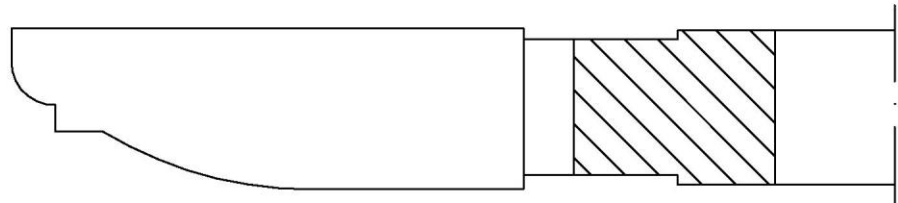
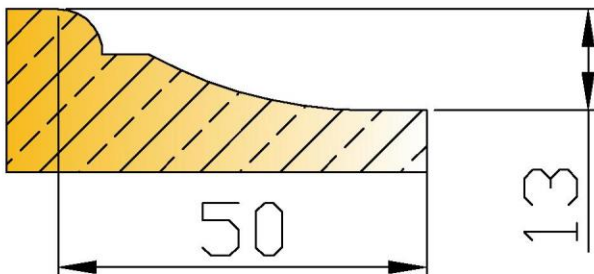
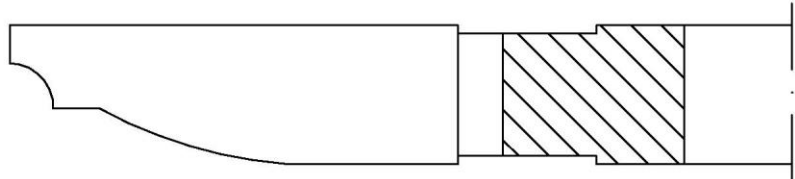
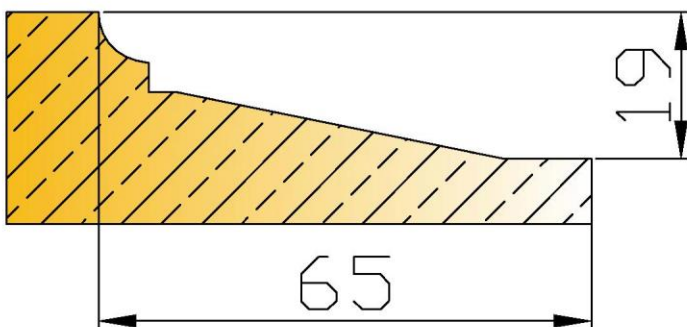
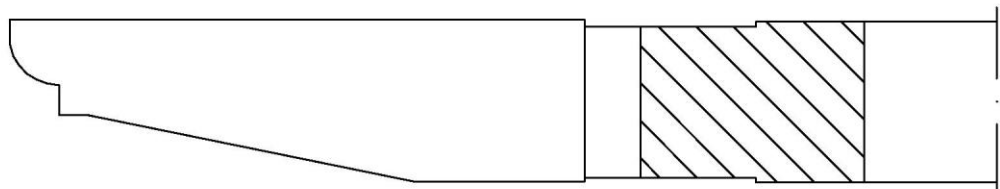
**FP-43****FP-44****FP-45**

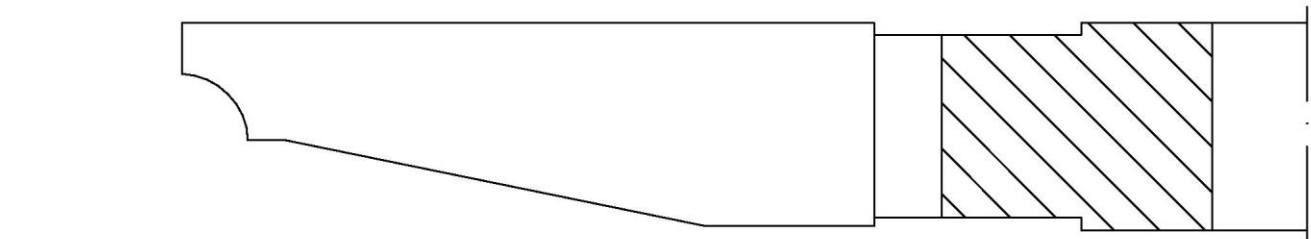
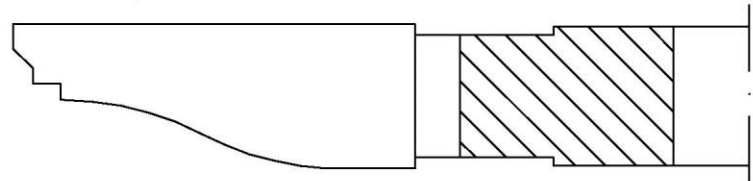
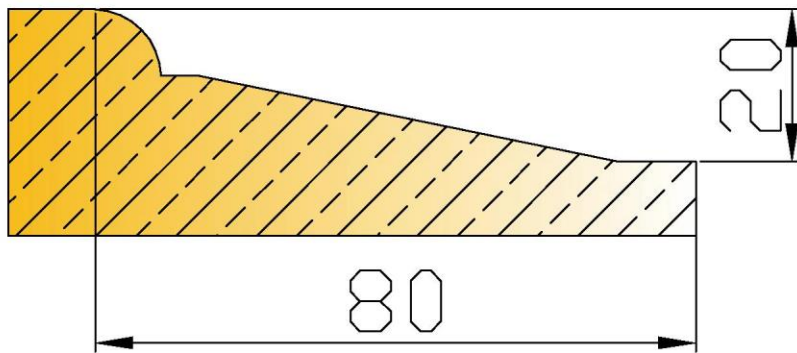
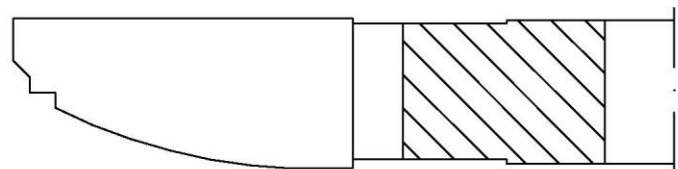
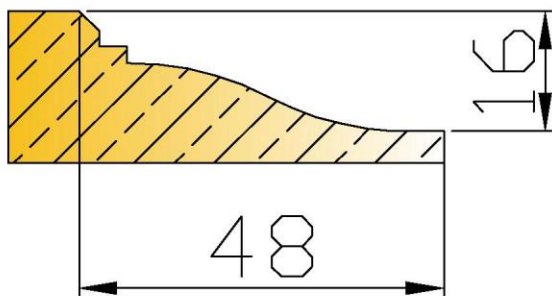
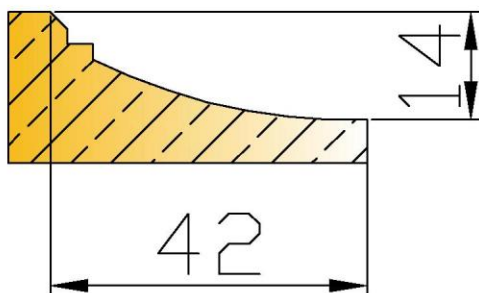
**FP-46****FP-47****FP-48**

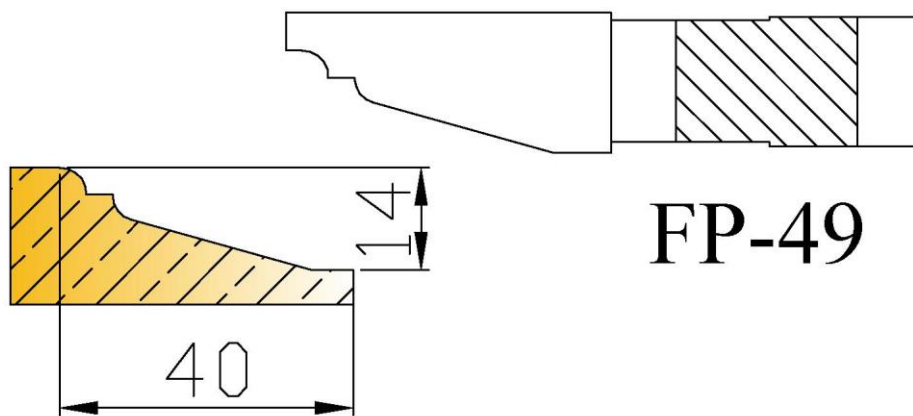
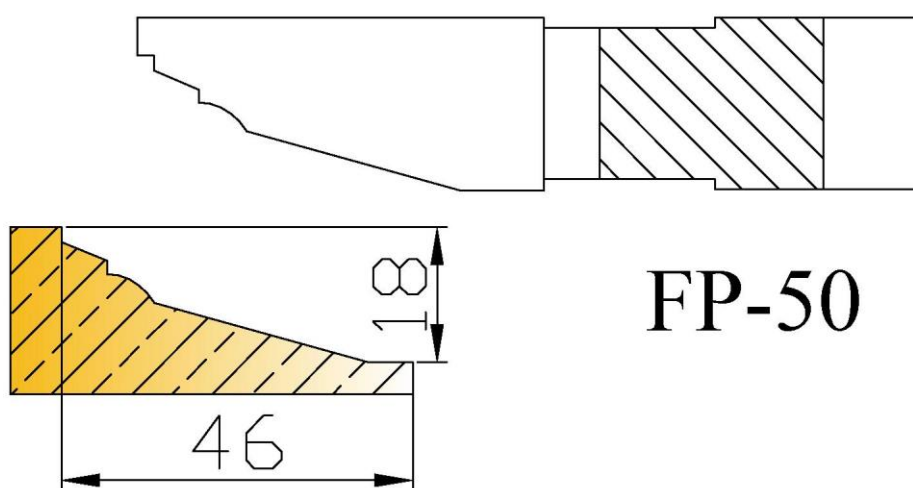
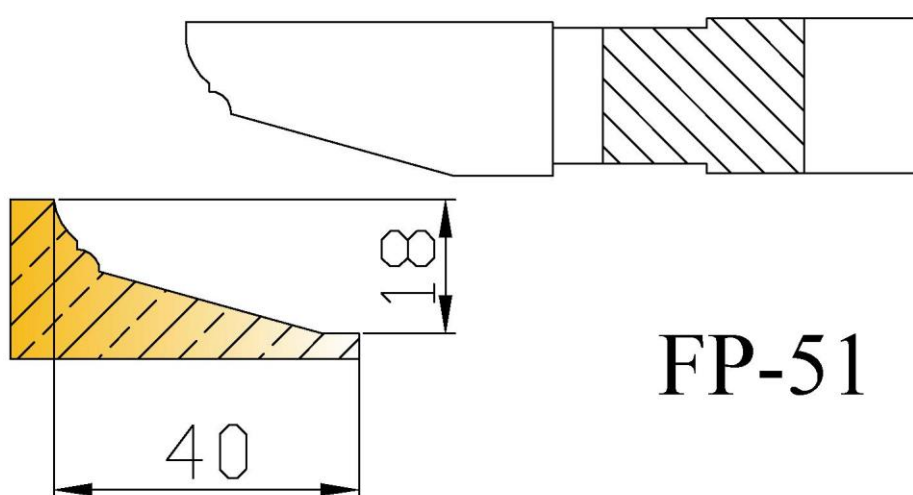
**FP-49****FP-50****FP-51**

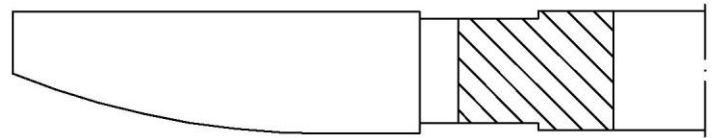
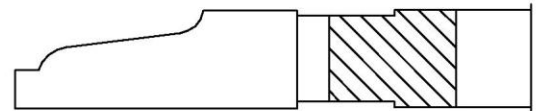
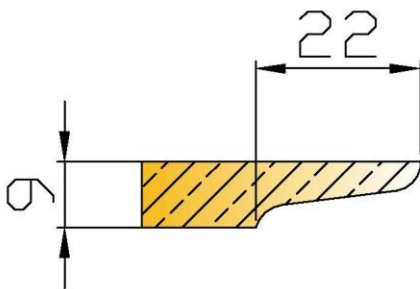
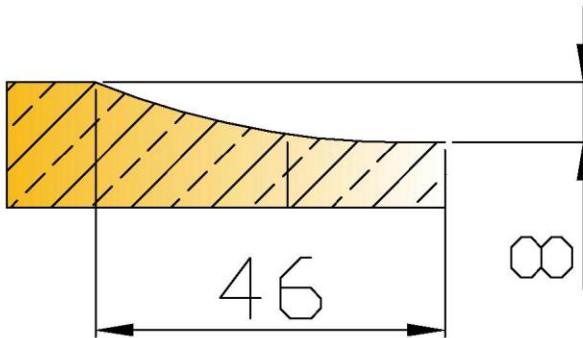
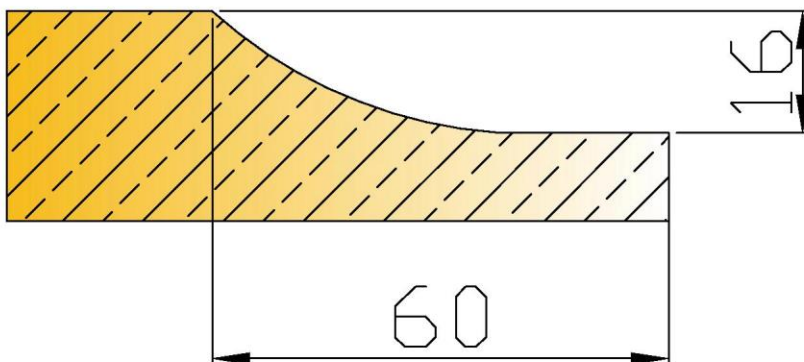
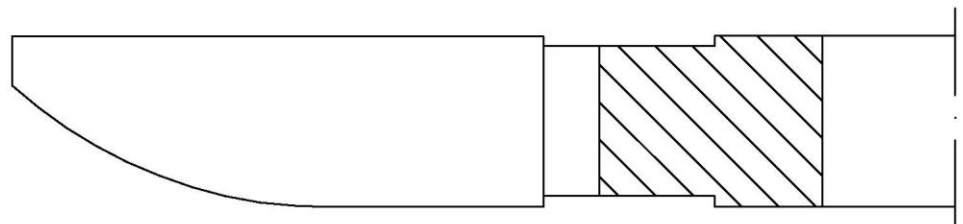
**FP-52****FP-53****FP-54**